



SGI® Tempo System Administrator's Guide

007-4993-007

COPYRIGHT

© 2007, 2008, 2009, SGI. All rights reserved; provided portions may be copyright in third parties, as indicated elsewhere herein. No permission is granted to copy, distribute, or create derivative works from the contents of this electronic documentation in any manner, in whole or in part, without the prior written permission of SGI.

The SGI Tempo systems management software stack depends on several open source packages which require attribution. They are as follows:

c3:

C3 version 3.1.2: Cluster Command & Control Suite Oak Ridge National Laboratory, Oak Ridge, TN, Authors: M.Brim, R.Flanery, G.A.Geist, B.Luethke, S.L.Scott (C) 2001 All Rights Reserved NOTICE Permission to use, copy, modify, and distribute this software and # its documentation for any purpose and without fee is hereby granted provided that the above copyright notice appear in all copies and that both the copyright notice and this permission notice appear in supporting documentation. Neither the Oak Ridge National Laboratory nor the Authors make any # representations about the suitability of this software for any purpose. This software is provided "as is" without express or implied warranty. The C3 tools were funded by the U.S. Department of Energy.

conserver:

Copyright (c) 2000, conserver.com All rights reserved. Redistribution and use in source and binary forms, with or without modification, are permitted provided that the following conditions are met:- Redistributions of source code must retain the above copyright notice, this list of conditions and the following disclaimer. - Redistributions in binary form must reproduce the above copyright notice, this list of conditions and the following disclaimer in the documentation and/or other materials provided with the distribution. - Neither the name of conserver.com nor the names of its contributors may be used to endorse or promote products derived from this software without specific prior written permission. THIS SOFTWARE IS PROVIDED BY THE COPYRIGHT HOLDERS AND CONTRIBUTORS "AS IS" AND ANY EXPRESS OR IMPLIED WARRANTIES, INCLUDING, BUT NOT LIMITED TO, THE IMPLIED WARRANTIES OF MERCHANTABILITY AND FITNESS FOR A PARTICULAR PURPOSE ARE DISCLAIMED. IN NO EVENT SHALL THE REGENTS OR CONTRIBUTORS BE LIABLE FOR ANY DIRECT, INDIRECT, INCIDENTAL, SPECIAL, EXEMPLARY, OR CONSEQUENTIAL DAMAGES (INCLUDING, BUT NOT LIMITED TO, PROCUREMENT OF SUBSTITUTE GOODS OR SERVICES; LOSS OF USE, DATA, OR PROFITS; OR BUSINESS INTERRUPTION) HOWEVER CAUSED AND ON ANY THEORY OF LIABILITY, WHETHER IN CONTRACT, STRICT LIABILITY, OR TORT (INCLUDING NEGLIGENCE OR OTHERWISE) ARISING IN ANY WAY OUT OF THE USE OF THIS SOFTWARE, EVEN IF ADVISED OF THE POSSIBILITY OF SUCH DAMAGE.

Copyright (c) 1998, GNAC, Inc. All rights reserved. Redistribution and use in source and binary forms, with or without modification, are permitted provided that the following conditions are met: - Redistributions of source code must retain the above copyright notice, this list of conditions and the following disclaimer. - Redistributions in binary form must reproduce the above copyright notice, this list of conditions and the following disclaimer in the documentation and/or other materials provided with the distribution. - Neither the name of GNAC, Inc. nor the names of its contributors may be used to endorse or promote products derived from this software without specific prior written permission. THIS SOFTWARE IS PROVIDED BY THE COPYRIGHT HOLDERS AND CONTRIBUTORS "AS IS" AND ANY EXPRESS OR IMPLIED WARRANTIES, INCLUDING, BUT NOT LIMITED TO, THE IMPLIED WARRANTIES OF MERCHANTABILITY AND FITNESS FOR A PARTICULAR PURPOSE ARE DISCLAIMED. IN NO EVENT SHALL THE REGENTS OR CONTRIBUTORS BE LIABLE FOR ANY DIRECT, INDIRECT, INCIDENTAL, SPECIAL, EXEMPLARY, OR CONSEQUENTIAL DAMAGES (INCLUDING, BUT NOT LIMITED TO, PROCUREMENT OF SUBSTITUTE GOODS OR SERVICES; LOSS OF USE, DATA, OR PROFITS; OR BUSINESS INTERRUPTION) HOWEVER CAUSED AND ON ANY THEORY OF LIABILITY, WHETHER IN CONTRACT, STRICT LIABILITY, OR TORT (INCLUDING NEGLIGENCE OR OTHERWISE) ARISING IN ANY WAY OUT OF THE USE OF THIS SOFTWARE, EVEN IF ADVISED OF THE POSSIBILITY OF SUCH DAMAGE.

Copyright 1992 Purdue Research Foundation, West Lafayette, Indiana 47907. All rights reserved. This software is not subject to any license of the American Telephone and Telegraph Company or the Regents of the University of California. Permission is granted to anyone to use this software for any purpose on any computer system, and to alter it and redistribute it freely, subject to the following

restrictions: 1. Neither the authors nor Purdue University are responsible for any consequences of the use of this software. 2. The origin of this software must not be misrepresented, either by explicit claim or by omission. Credit to the authors and Purdue University must appear in documentation and sources. 3. Altered versions must be plainly marked as such, and must not be misrepresented as being the original software. 4. This notice may not be removed or altered.

Copyright (c) 1990 The Ohio State University. All rights reserved. Redistribution and use in source and binary forms are permitted provided that: (1) source distributions retain this entire copyright notice and comment, and (2) distributions including binaries display the following acknowledgment: "This product includes software developed by The Ohio State University and its contributors" in the documentation or other materials provided with the distribution and in all advertising materials mentioning features or use of this software. Neither the name of the University nor the names of its contributors may be used to endorse or promote products derived from this software without specific prior written permission. THIS SOFTWARE IS PROVIDED "AS IS" AND WITHOUT ANY EXPRESS OR IMPLIED WARRANTIES, INCLUDING, WITHOUT LIMITATION, THE IMPLIED WARRANTIES OF MERCHANTABILITY AND FITNESS FOR A PARTICULAR PURPOSE. Permission to use, copy, modify, and distribute this software and its documentation for any purpose and without fee is hereby granted, provided that the above copyright notice appear in all copies and that both that copyright notice and this permission notice appear in supporting documentation. This program is distributed in the hope that it will be useful, but WITHOUT ANY WARRANTY; without even the implied warranty of MERCHANTABILITY or FITNESS FOR A PARTICULAR PURPOSE.

pysqlite:

Permission to use, copy, modify, and distribute this software and its documentation for any purpose and without fee is hereby granted, provided that the above copyright notice appear in all copies and that both that copyright notice and this permission notice appear in supporting documentation.

This program is distributed in the hope that it will be useful, but WITHOUT ANY WARRANTY; without even the implied warranty of MERCHANTABILITY or FITNESS FOR A PARTICULAR PURPOSE.

LIMITED RIGHTS LEGEND

The software described in this document is "commercial computer software" provided with restricted rights (except as to included open/free source) as specified in the FAR 52.227-19 and/or the DFAR 227.7202, or successive sections. Use beyond license provisions is a violation of worldwide intellectual property laws, treaties and conventions. This document is provided with limited rights as defined in 52.227-14.

TRADEMARKS AND ATTRIBUTIONS

SGI, Altix, the SGI cube, the SGI logo, and Silicon Graphics are registered trademarks and Performance Co-Pilot and SGI ProPack are trademarks of SGI in the United States and/or other countries worldwide.

Altair is a registered trademark and PBS Professional is a trademark of Altair Engineering, Inc. Intel, Xeon, and Itanium are trademarks or registered trademarks of Intel Corporation. InfiniBand is a trademark of the InfiniBand Trade Association. Linux is a registered trademark of Linus Torvalds. LSI Logic is a registered trademark of the LSI Logic Corporation. Novell is a registered trademark and SUSE is a trademark of Novell, Inc., in the United States and other countries. Red Hat and all Red Hat-based trademarks are trademarks or registered trademarks of Red Hat, Inc. in the United States and other countries.

All other trademarks mentioned herein are the property of their respective owners.

New Features in This Manual

This rewrite of the *SGI Tempo System Administrator's Guide* supports the SGI Tempo systems management software (v1.6).

Major Documentation Changes

Performed the following:

- Added "Installing RHEL on the Admin Node" on page 43.
- Added "RHEL Service Node House Network Configuration " on page 94.
- Added "InfiniBand Configuration" on page 77.
- Added "Update the RHEL Package Repository" on page 113.
- Added "Cascading Dual-Boot" on page 117.
- Added information about a new `sgifmcli(8)` command in "Fabric Component" on page 184.
- Added information about MASTER/STANDBY configuration of the InfiniBand fabric in "InfiniBand Fabric Failover Mechanism" on page 206.
- Updated "Node Availability Monitoring" on page 244.

Record of Revision

Version	Description
001	July 2007 Original publication.
002	October 2007 Updated to support the SGI Tempo systems management software (v1.1)
003	January 2008 Updated to support the SGI Tempo systems management software (v1.2)
004	May 2008 Updated to support the SGI Tempo systems management software (v1.3)
005	July 2008 Updated to support the SGI Tempo systems management software (v1.4)
006	October 2008 Updated to support the SGI Tempo systems management software (v1.5)
007	January 2009 Updated to support the SGI Tempo systems management software (v1.6)

Contents

About This Guide	xxvii
Related Publications	xxvii
Obtaining Publications	xxviii
Conventions	xxviii
Reader Comments	xxix
1. SGI Altix ICE 8200 Series System Overview	1
Hardware Overview	1
Basic System Building Blocks	1
InfiniBand Fabric	3
Gigabit Ethernet Network	4
Individual Rack Unit	4
Power Supply	5
Four-tier, Hierarchical Framework	5
Chassis Manager	6
System Nodes	8
System Admin Controller	8
Rack Leader Controller	9
Chassis Management Control (CMC) Blade	9
Compute Node	10
Individual Rack Unit	11
Login Service Node	11
Batch Service Node	11
Gateway Service Node	11

Storage Service Node	12
Networks	13
Networks Overview	13
Gigabit Ethernet (GigE) and 10/100 Ethernet Connections	15
VLANs	17
InfiniBand Fabric	21
Network Interface Naming Conventions	22
System Component Names	23
VLAN_Head Network Connections	23
VLAN_GBE Network Connections	24
VLAN_BMC Network Connections	25
VLAN_1588 Network Connections	25
Non-resolvable Names	26
Hostnames	26
InfiniBand Network	28
2. System Discovery, Installation, and Configuration	29
Configuring Factory-installed SGI Altix ICE System	30
Overview of Installing Software and Configuring Your SGI Altix ICE System	31
Installing Software on the System Admin Controller	31
Installing SLES on the Admin Node	32
Installing RHEL on the Admin Node	43
configure-cluster Command Cluster Configuration Tool	47
discover Command	68
Installing Software on the Rack Leader Controllers and Service Nodes	72
blademond Command For Automatic Blade Discovery	75
Discovering Compute Nodes	76
Service Node Discovery, Installation and Configuration	77

InfiniBand Configuration	77
Configuring the Service Node	80
Service Node Configuration for NAT	80
Troubleshooting Service Node Configuration for NAT	82
Using External DNS for Compute Node Name Resolution	83
Service Node Configuration for DNS	84
Service Node Configuration for NFS	84
Service Node Configuration for NIS for the House Network	85
Setting Up an NFS Home Server on a Service Node for Your Altix ICE System	86
Partitioning, Creating, and Mounting Filesystems	88
Home Directories on NAS	92
Service Node NFS Server Alternate: Re-exporting House NFS Servers	92
RHEL Service Node House Network Configuration	94
Setting Up a NIS Server for Your Altix ICE System	95
Setting Up a NIS Server Overview	96
Setting Up a SLES Service Node as a NIS Master	96
Setting Up a RHEL Service Node as a NIS Master	98
Setting Up a SLES Service Node as a NIS Client	99
Setting up a SLES Rack Leader Controller as a NIS Slave Server and Client	100
Setting up a RHEL Rack Leader Controller as a NIS Slave Server and Client	101
Setting Up a RHEL Service Node as a NIS Client	103
Setting up RHEL Compute Nodes to be NIS Clients	104
Setting up the SLES Compute Nodes to be NIS Clients	105
NAS Configuration for Multiple IB Interfaces	106
Creating User Accounts	108
Tasks You Should Perform After Changing a Rack Leader Controller	109

Installing SGI Tempo Patches and Updating SGI Altix ICE Systems	109
Overview	109
Update the Local Package Repositories on the Admin Node	110
Update the SGI Package Repositories on the Admin Node	110
Update the SLES Package Repository	111
Update the RHEL Package Repository	113
Installing Updates on Running Admin, Leader, and Service Nodes	114
Updating Packages Within Systemimager Images	115
Additional Steps for Compute Image Kernel Updates	116
Upgrading from SGI ProPack 6 SP1 to SGI ProPack 6 SP2	117
Cascading Dual-Boot	117
Partition Layout for Admin, Leader, and Service Nodes with Multiroot	118
Partition Layout for a Single Root	119
Admin Node Installation Choices Related to Cascading Dual-Boot	119
Leader and Service Node Installation	120
Choosing a Slot to Boot the Admin Node	121
How to Handle Resets, Power Cycles, and BMC dhcp Leases When Changing Slots	121
Leader and Service Node Booting	122
Leader and Service Node Booting on a System Configured with One Root Slot	122
Leader and Service Node Booting on a System Configured with Multiple Roots Slots	122
Slot Cloning	123
Admin Node: Managing Which Slot Boots by Default	124
Admin Node: Managing Grub Labels	124
Admin Node: Which root slot is in use?	125
3. System Operation	127
Software Image Management	127

Compute Node Services Turned Off by Default	128
<code>crepo</code> Command	129
<code>cinstallman</code> Command	131
Customizing Software On Your SGI Altix ICE System	134
Creating Compute Node Custom Images	134
Compute Node Per-Host Customization for Additional Network Interfaces	136
Customizing Software Images	137
<code>cimage</code> Command	141
Using <code>cinstallman</code> to Install Packages into Software Images	145
Using <code>yum</code> to Install Packages on Running Service or Leader Nodes	146
Creating Compute and Service Node Images Using the <code>cinstallman</code> Command	146
Installing a Service Node with a Non-default Image	148
Using a Custom Repository for Site Packages	149
SGI Altix ICE System Configuration Framework	149
Cluster Configuration Repository: Updates on Demand	152
<code>cnodes</code> Command	153
Power Management Commands	154
<code>cpower</code> Command	154
Operations on Nodes	155
IPMI-style Commands	156
IRU, Rack, and System Domains	157
Shutting Down and Booting	157
C3 Commands	160
<code>cadmin</code> : SGI Tempo Administrative Interface	165
Console Management	168
Keeping System Time Synchronized	170
System Admin Controller NTP	171

Rack Leader Controller NTP	171
Managed Service, Compute, and Leader BMC Setup with NTP	171
Service Node NTP	171
Compute Node NTP	171
NTP Work Arounds	172
Changing the Size of /tmp on Compute Nodes	172
Disabling Swap Space	173
Changing the Size of Per-node Swap Space	174
Switching Compute Nodes to a tmpfs Root	175
Viewing the Compute Node Read-Write Quotas	176
RAID Utility	178
Backing up and Restoring the System Database	181
4. System Fabric Management	183
InfiniBand Fabric Management	183
InfiniBand Fabric Overview	183
Fabric Component	184
sgifmcli SGI Fabric Component Command	185
dbversion SGI Fabric Component Command	189
InfiniBand Fabric Administrative Commands	190
InfiniBand Fabric Management Command	191
smconfig Fabric Configuration Command	193
smadmin InfiniBand Fabric Administration Command	195
InfiniBand Fabric Management Configuration and Operation Overview	199
Network Topology	204
Configuring the InfiniBand Fat-tree Network Topology	205
InfiniBand Fabric Failover Mechanism	206
Configuring and Initializing the InfiniBand Fabric Manually	210

Useful Utilities and Diagnostics	213
ibstat and ibstatus Commands	214
perfquery Command	216
ibnetdiscover Command	217
ibdiagnet Command	218
5. System Maintenance, Monitoring, and Debugging	223
Maintenance Procedures	223
Temporarily Take a Node Offline for Maintenance	223
Permanently Replace a Failed Blade	224
Permanently Remove a Blade	225
Add a New Blade	226
Node Replacement Procedure for a Cold Spare Admin, Leader, and Service Nodes	226
Cold Spare Admin or Leader Node Availability	227
Shelf Spare Hardware Limitations	228
Tools Required	228
Identify the Failed Unit and Unplug all Cables	228
Transfer Disks from Existing Server to the Cold Spare	232
Migrating to a Cold Spare: Importing the Disk Volumes	232
Migrating to a Cold Spare: Booting for the First Time on the Migrated Node	234
Inventory Verification Tool	236
System Monitoring Overview	239
System Monitoring Operation	242
Accessing the Ganglia System Monitor	243
Monitoring System Metrics	243
SEL/Hardware Event Monitoring	243
Node Availability Monitoring	244

Monitoring System Metrics with Performance Co-Pilot	245
Configuring Compute Blade Metrics	246
Monitoring SDR Metrics	248
Cluster Performance Monitor	249
Setting up the Embedded Support Partner	250
Troubleshooting	252
dbdump Command	252
tempo-info-gather Command	254
cminfo Command	255
kdump Utility	256
System Firmware	257
BIOS Version Interrogation	257
BMC Revision Interrogation	257
CMC Version Interrogation	258
InfiniBand Version Interrogation	258
Getting Firmware Information for All System Nodes	258
Index	261

Figures

Figure 1-1	Basic System Building Blocks	2
Figure 1-2	Chassis Manager Cabling	7
Figure 1-3	Service Nodes	12
Figure 1-4	Network Connections In a System With Two IRUs	14
Figure 1-5	Chassis Manager	15
Figure 1-6	VLAN_GBE and VLAN_BMC Network Connections - IRU View	18
Figure 1-7	VLAN_GBE and VLAN_BMC Network Connections – Rack View	19
Figure 1-8	VLAN_HEAD Network Connections	20
Figure 1-9	Two InfiniBand Fabrics in a System with Two IRUs	22
Figure 2-1	System Admin Controller Power On Button and DVD Drive	32
Figure 2-2	YaST Welcome Screen	36
Figure 2-3	Hostname and Name Server Configuration Screen	37
Figure 2-4	Network Card Configuration Interfaces Screen	38
Figure 2-5	Network Card Configuration Overview Screen	39
Figure 2-6	Network Address Setup Screen	40
Figure 2-7	Hostname and Name Server Configuration Screen	41
Figure 2-8	Installation Completed Screen	42
Figure 2-9	Cluster Configuration Tool: Initial Configuration Check Screen	48
Figure 2-10	Cluster Configuration Tool: Initial Cluster Setup Screen	49
Figure 2-11	Initial Cluster Setup Tasks Screen	50
Figure 2-12	Cluster Configuration Tool: Repo Manager Screen One	51
Figure 2-13	Cluster Configuration Tool: Repo Manager Screen Two	52
Figure 2-14	Cluster Configuration Tool: Repo Manager Screen Three	53

Figure 2-15	Cluster Configuration Tool: Repo Manager Screen Four	54
Figure 2-16	Cluster Configuration Tool: Repo Manager: Add Media Screen Four	55
Figure 2-17	Cluster Network Setup Screen	56
Figure 2-18	Update Subnet Address Warning Screen	57
Figure 2-19	Update Subnet Addresses Screen	58
Figure 2-20	Update Cluster Domain Name Screen	59
Figure 2-21	NTP Time Server/Client Setup Screen	60
Figure 2-22	Advance NTP Configuration Screen	61
Figure 2-23	New Synchronization Screen	62
Figure 2-24	NTP Server Screen	63
Figure 2-25	NTP Time Server/ Client Setup Screen Three	64
Figure 2-26	Admin Infrastructure One Time Setup Screen One	65
Figure 2-27	Configure House DNS Resolvers Screen	66
Figure 2-28	Setting DNS Forwarding Screen	67
Figure 2-29	Cluster Configuration Tool: Admin Infrastructure One Time Setup Screen	68
Figure 2-30	Configure InfiniBand Fabric from Cluster Configuration Tool	78
Figure 2-31	InfiniBand Management Tool Screen	79
Figure 2-32	Administer InfiniBand GUI	80
Figure 4-1	InfiniBand Management Tool Screen	192
Figure 4-2	Administer InfiniBand Tool	193
Figure 4-3	Two InfiniBand Fabrics in a System with Two IRUs	204
Figure 4-4	opensm Software Failover	206
Figure 5-1	Admin/RLC Server Front Panel Controls and Indicator LEDs	229
Figure 5-2	Admin/Leader to CMC Cable Examples	231
Figure 5-3	Admin/Leader Server Front Features and Rear Connector Locations	232
Figure 5-4	Ganglia System Monitor	240
Figure 5-5	Ganglia System Monitoring Node View	242

Figure 5-6 pmie- Cluster Performance Monitor 249

Examples

Example 2-1	<code>discover</code> Command Examples	71
Example 2-2	<code>tcpdump</code> Command Examples	82
Example 3-1	<code>cimage</code> Command Examples	142
Example 3-2	<code>cnodes</code> Example	153
Example 3-3	<code>cpower</code> Command Examples	159
Example 3-4	C3 Command General Examples	161
Example 3-5	C3 Command Specific Use Examples	164
Example 3-6	SGI Tempo Administrative Interface (<code>cadmin</code>) Command	167
Example 3-7	Using the <code>lsiutil</code> Utility	178
Example 4-1	Initialize an External InfiniBand Switch	186
Example 4-2	Change Settings for External InfiniBand Switch	187
Example 4-3	Remove an External InfiniBand Switch	187
Example 4-4	Verify the InfiniBand Fabric	187
Example 4-5	Getting <code>sgifmcli(8)</code> Command Help	189
Example 4-6	Getting <code>dbversion(8)</code> Command Help	190
Example 4-7	Getting the Database Version	190
Example 4-8	<code>opensm-ib0.conf</code> and <code>opensm-ib1.conf</code> Configuration Files	199
Example 5-1	<code>dbdump</code> Command Examples	253
Example 5-2	<code>cminfo</code> Command Examples	256

Procedures

Procedure 2-1	Configuring Factory-installed SGI Altix ICE System	30
Procedure 2-2	Overview of Installing Software and Configuring Your SGI Altix ICE System	31
Procedure 2-3	Installing Software on the System Admin Controller	32
Procedure 2-4	Installing RHEL on the Admin Node Using Text Firstboot	43
Procedure 2-5	Installing RHEL on the Admin Node Using Graphical Firstboot	44
Procedure 2-6	Repair <code>/etc/hosts</code> File	45
Procedure 2-7	Using the Cluster Configuration Tool to Configure Your System Admin Controller	47
Procedure 2-8	Installing Software on the Rack Leader Controllers and Service Nodes .	72
Procedure 2-9	Discovering Compute Nodes	76
Procedure 2-10	Service Node Configuration for NAT	81
Procedure 2-11	Service Node Configuration for NFS	84
Procedure 2-12	NIS with Compute Nodes Directly Accessing the House NIS Infrastructure	85
Procedure 2-13	NIS with a Service Node as a NIS Slave Server to the House NIS Master	85
Procedure 2-14	Partitioning and Creating Filesystems for an NFS Home Server on a Service Node	88
Procedure 2-15	Service Node NFS Server Alternate: Re-exporting House NFS Servers .	92
Procedure 2-16	Setting Up a SLES Service Node as a NIS master	96
Procedure 2-17	Setting Up a RHEL Service Node as a NIS master	98
Procedure 2-18	Setting Up a SLES Service Node as a NIS Client	99
Procedure 2-19	Setting up a Rack Leader Controller as a NIS Slave Server and Client .	101
Procedure 2-20	Setting Up a RHEL Service Node as a NIS Client	101
Procedure 2-21	Setting Up a RHEL Service Node as a NIS Client	103
Procedure 2-22	Setting up RHEL Compute Nodes to be NIS Clients	104

Procedure 2-23	Setting up the Compute Nodes to be NIS Clients	105
Procedure 2-24	Creating User Accounts on a NIS Server	108
Procedure 3-1	Clone a Compute Node Image	138
Procedure 3-2	Manually Adding a Package to a Compute Node Image	138
Procedure 3-3	Creating a Simple Compute Node Image Clone	140
Procedure 3-4	Manually Adding a Package to the Service Node Image	140
Procedure 3-5	Using the <code>cinstallman</code> Command to Create a Service Node Image: . . .	146
Procedure 3-6	Use the <code>cinstallman</code> Command to Create a Compute Node Image . . .	147
Procedure 3-7	Setting Up a Custom Repository for Site Packages	149
Procedure 3-8	Using <code>conserver</code> Console Manager	169
Procedure 3-9	Increasing the <code>/tmp</code> Size	172
Procedure 3-10	Disabling Swap Space	173
Procedure 3-11	Increasing Per-node Swap Space	174
Procedure 3-12	Switching Compute Nodes to a <code>tmpfs</code> Root	175
Procedure 3-13	Viewing the Compute Node Read-Write Quotas	176
Procedure 3-14	Backing up and Restoring the System Database	181
Procedure 4-1	Using the <code>smconfig</code> Command to Configure the InfiniBand Fabric . . .	195
Procedure 4-2	Using the <code>smadmin</code> Command to Administer the InfiniBand Fabric . . .	196
Procedure 4-3	Troubleshooting the InfiniBand Fabric	198
Procedure 4-4	Configuring InfiniBand Fat-tree Network Topology	205
Procedure 4-5	Enabling the InfiniBand Failover Mechanism	207
Procedure 4-6	Configuring and Initializing the InfiniBand Fabric Manually	210
Procedure 5-1	Temporarily Take a Node Offline for Maintenance	224
Procedure 5-2	Permanently Replace a Failed Blade	224
Procedure 5-3	Permanently Remove a Blade	225
Procedure 5-4	Add a New Blade	226

Procedure 5-5	Replacing a Node with a Cold Spare: Installing the Hardware	229
Procedure 5-6	Migrating to a Shelf Spare: Importing the Disk Volumes	233
Procedure 5-7	Migrating to a Cold Spare: Booting for the First Time on the Migrated Node	234
Procedure 5-8	Setting up the Embedded Support Partner	250

About This Guide

This guide is a reference document for people who manage the operation of SGI Altix ICE 8200 series systems running SUSE Linux Enterprise Server 10 Service Pack 2 or Red Hat Enterprise Linux 5.2 (RHEL 5.2) with SGI ProPack 6 for Linux Service Pack 2. It describes how to use SGI Tempo systems management software (v1.6) to perform general system discovery, installation, configuration, and operations on SGI Altix ICE 8200 series systems.

This manual contains the following chapters:

- Chapter 1, "SGI Altix ICE 8200 Series System Overview" on page 1
- Chapter 2, "System Discovery, Installation, and Configuration" on page 29
- Chapter 3, "System Operation" on page 127
- Chapter 4, "System Fabric Management" on page 183
- Chapter 5, "System Maintenance, Monitoring, and Debugging" on page 223

Related Publications

This section describes documentation you may find useful, as follows:

- *SGI Altix ICE 8200 System Hardware User's Guide*

This is the hardware user's guide for the SGI Altix ICE 8200 series systems. It describes the features of the SGI Altix ICE 8200 series system, as well as, troubleshooting, upgrading, and repairing.

For a list of manuals supporting SGI ProPack for Linux releases covering the following topics, see the *SGI ProPack 6 for Linux Service Pack 1 Start Here*:

- SGI documentation supporting SGI Altix ICE systems
- Novell documentation for SUSE Linux Enterprise Server 10 (SLES10)
- Intel Compiler Documentation
- Intel documentation about Xeon architecture

Obtaining Publications

You can obtain SGI documentation in the following ways:

- See the SGI Technical Publications Library at: <http://docs.sgi.com>. Various formats are available. This library contains the most recent and most comprehensive set of online books, release notes, man pages, and other information.
- Online versions of the *SGI ProPack 6 for Linux Service Pack 2 Start Here*, the SGI ProPack 6 Service Pack 2 release notes, which contain the latest information about software and documentation in this release, the list of RPMs distributed with SGI ProPack 6 can be found in the `/docs` directory on the SGI ProPack 6 CD.

The SGI ProPack 6 for Linux release notes get installed to the following location on a system running SGI ProPack 6:

`/usr/share/doc/sgi-propack-6/README.txt`.

- You can view man pages by typing `man title` on a command line.

Conventions

The following conventions are used throughout this document:

Convention	Meaning
<code>command</code>	This fixed-space font denotes literal items such as commands, files, routines, path names, signals, messages, and programming language structures.
<i>variable</i>	Italic typeface denotes variable entries and words or concepts being defined.
user input	This bold, fixed-space font denotes literal items that the user enters in interactive sessions. (Output is shown in nonbold, fixed-space font.)
[]	Brackets enclose optional portions of a command or directive line.

... Ellipses indicate that a preceding element can be repeated.

Reader Comments

If you have comments about the technical accuracy, content, or organization of this publication, contact SGI. Be sure to include the title and document number of the publication with your comments. (Online, the document number is located in the front matter of the publication. In printed publications, the document number is located at the bottom of each page.)

You can contact SGI in any of the following ways:

- Send e-mail to the following address:
techpubs@sgi.com
- Contact your customer service representative and ask that an incident be filed in the SGI incident tracking system.
- Send mail to the following address:
SGI
Technical Publications
1140 East Arques Avenue
Sunnyvale, CA 94085-4602

SGI values your comments and will respond to them promptly.

SGI Altix ICE 8200 Series System Overview

The SGI Altix Integrated Compute Environment (ICE) 8200 series systems are an integrated blade environment that can scale to thousands of nodes. The SGI Tempo systems management software enables you to provision, install, configure, and manage your system. This chapter provides an overview of the SGI Altix ICE 8200 series system and covers the following topics:

- "Hardware Overview" on page 1
- "Networks" on page 13
- "Network Interface Naming Conventions" on page 22

Hardware Overview

This section provides a brief overview of the SGI Altix ICE 8200 series system hardware and covers the following topics:

- "Basic System Building Blocks" on page 1
- "System Nodes" on page 8

For a detailed description, see the *SGI Altix ICE 8200 Series System Hardware User's Guide*.

Basic System Building Blocks

The SGI Altix ICE 8200 system is a blade-based, scalable, high density compute system. The basic building block is the individual rack unit (IRU). The IRU provides power, cooling, system control, and the network fabric for 16 compute blades, as shown in Figure 1-1 on page 2. Each compute blade supports two either dual-core or quad-core Xeon processor sockets and eight fully-buffered, double-data-rate two (DDR2) memory dual in-line memory module (DIMMs). Four IRUs can reside in a custom designed 42U high rack.

One rack supports a maximum of 512 processor cores and 2TB of memory.

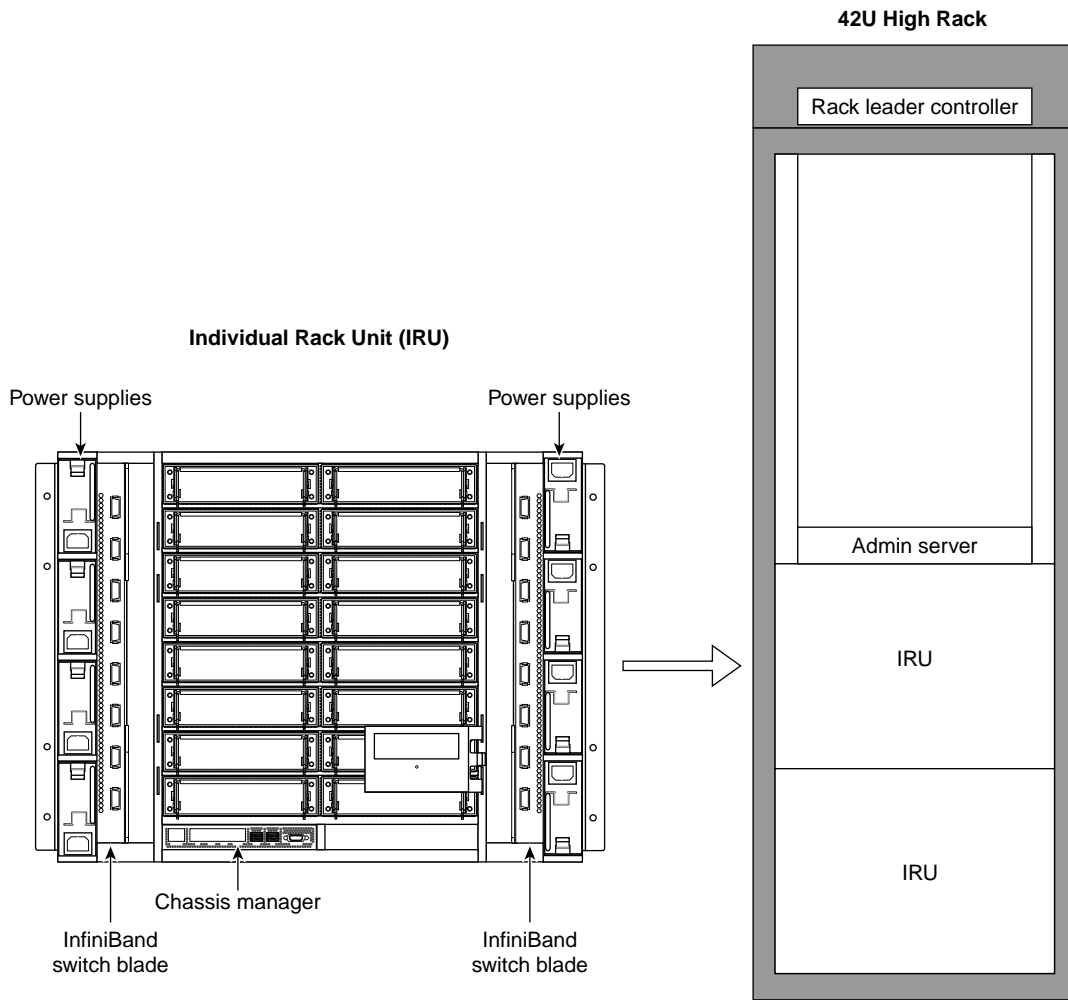

Figure 1-1 Basic System Building Blocks

This hardware overview section covers the following topics:

- "InfiniBand Fabric" on page 3
- "Gigabit Ethernet Network" on page 4
- "Individual Rack Unit" on page 4

- "Power Supply" on page 5
- "Four-tier, Hierarchical Framework" on page 5
- "Chassis Manager" on page 6

InfiniBand Fabric

The SGI Altix ICE 8200 system topology is based on an InfiniBand interconnect. Internal InfiniBand switch ASICs of the IRU eliminate the need for external InfiniBand switches. The dual high-speed, low-latency double data rate (DDR) InfiniBand backplanes built into the IRUs provide for fast communication between nodes and racks.

An InfiniBand switch blade provides the interface between compute blades within the same chassis and also between compute blades in separate IRUs. Fabric management software monitors and controls the InfiniBand fabric. SGI Altix ICE 8200 systems are configured with two InfiniBand fabrics, designated as `ib0` and `ib1`. In order to maximize performance, SGI advises that the `ib0` fabric be used for all MPI traffic, in this case, for example SGI MPT. The `ib1` fabric is reserved for storage related traffic. The default configuration for MPI is to use only the `ib0` fabric. For more information on the InfiniBand fabric, see Chapter 4, "System Fabric Management" on page 183.

Note: The "`ib0` fabric" is a convenient shorthand for "the fabric which is connected to the `ib0` interface on most of the nodes". In the case of the storage service node, there are four interfaces called `ib0` through `ib3`, all of which are connected to the `ib1` fabric (see "Storage Service Node " on page 12 and "NAS Configuration for Multiple IB Interfaces" on page 106).

The SGI Altix ICE system is a distributed memory system as opposed to a shared memory system like that used in the SGI Altix 450 or SGI Altix 4700 high-performance compute servers. Instead of passing pointers into a shared virtual address space, parallel processes in an application pass messages and each process has its own dedicated processor and address space.

Just like a multi-processor shared memory system, an SGI Altix ICE system can be shared among multiple applications. For instance, one application may run on 16 processors in the system while another application runs on a different set of eight processors. Very large systems may run dozens of separate, independent applications at the same time.

Typically, each process of an MPI job runs exclusively on a processor. Multiple processes can share a single processor, through standard Linux context switching, but this can have a significant effect on application performance. A parallel program can only finish when all of its sub-processes have finished. If one process is delayed because it is sharing a processor and memory with another application, then the entire parallel program is delayed. This gets slightly more complicated when systems have multiple processors (and/or multiple cores) that share memory, but the basic rule is that a process is run on a dedicated processor core.

Gigabit Ethernet Network

A Gigabit Ethernet connection network built into the backplane of the IRUs provides a control network isolated from application data. Transverse cables provide connection between IRUs and between racks. For more information on how the Gigabit Ethernet connection fabric is used, see "VLANs" on page 17.

Individual Rack Unit

Each IRU has a one chassis management control (CMC) blade located directly below compute blade slot 0 as shown in Figure 1-1 on page 2. This is the chassis manager that performs environmental control and monitoring of the IRU. The CMC controls master power to the compute blades under direction of the rack leader controller (leader node). The leader node can also query the CMC for monitored environmental data (temperatures, fan speeds, and so on) for the IRU.

Power control for each blade is handled by its Baseboard Management Controller (BMC), also under direction of the rack leader controller. Once the leader node has asked the CMC to enable master power, the leader node can then command each BMC to power up its associated blade. The leader node can also query each BMC to obtain some environmental and error log information about each blade.

Note: Setting the circuit breakers on the power distribution units (PDUs) to the "On" position will apply power to the IRU and will start the chassis manager in each IRU. Note that the chassis manager in each IRU stays powered on as long as there is power coming into the unit. Turn off the PDU breaker switch that supplies voltage to the IRU if you want to remove all power from the unit. For detailed information about powering your system on or off, see the "Powering the System On and Off" section in chapter 1 of the *SGI Altix ICE 8200 Series System Hardware User's Guide*.

The IRU provides data collected from compute nodes within the IRU to the leader node upon request.

Power Supply

The CMC and BMCs are powered by what is called "AUX POWER". This power supply is live any time the rack is plugged in and the main breakers are on. The CMC and BMCs are **not** able to be powered off under software control.

The compute blades have MAIN POWER which is controlled by the blade BMC. You can send a command to the BMC and have the main power to the associated blade turned on or off by that BMC.

The IRU has a MAIN POWER bus that feeds all of the blades. This main power bus can be turned on and off with a software command to the CMC. This "powering up of the IRU" turns on this main power, the fans in the IRU, and the power to the IB switches. The CMC, itself, is always powered on. This includes the Ethernet switch that is a part of the CMC.

Note: Setting the circuit breakers on the power distribution units (PDUs) to the "On" position will apply power to the IRU and will start the chassis manager in each IRU. Note that the chassis manager in each IRU stays powered on as long as there is power coming into the unit. Turn off the PDU breaker switch that supplies voltage to the IRU if you want to remove all power from the unit. For detailed information about powering your system on or off, see the "Powering the System On and Off" section in chapter 1 of the *SGI Altix ICE 8200 Series System Hardware User's Guide*.

Four-tier, Hierarchical Framework

The SGI Altix ICE 8200 system has a unique four-tier, hierarchical management framework as follows:

- System admin controller (admin node) – one per system
- Rack leader controller (leader node) – one per rack
- Chassis management controller (CMC) – one per IRU
- Baseboard Management Controller (BMC) – one per compute node, admin node, leader node, and managed service node

Unlike traditional, flat clusters, the SGI Altix ICE 8200 system does **not** have a head node. The head node is replaced by a hierarchy of nodes that enables system resources to scale as you add processors. This hierarchy is, as follows:

- System admin controller (admin node)
- Rack leader controller (leader node)
- Service Nodes
 - Login
 - Batch
 - Gateway
 - Storage

The one system admin controller can provision and control multiple leader nodes in the cluster. It receives aggregated cluster management data from the rack leader controllers (leader nodes).

Each system rack has its own leader node. The leader node holds the boot images for the compute blades and aggregates cluster management data for the rack.

Ethernet traffic for managing the nodes in a rack is constrained within the rack by the leader node. Communication and control is distributed across the entire cluster, thereby preventing the admin node from becoming a communication bottleneck. Administrative tasks, such as booting the cluster, can be done in parallel rack-by-rack in a matter of seconds. For very large configurations, the access infrastructure can also be scaled by adding additional login and batch service nodes. It is the VLAN logical networks that help prevent network traffic bottlenecks.

Note: Understanding the VLAN logical networks is critical to administering an SGI Altix ICE system. For more detailed information, see "VLANs" on page 17 and "Network Interface Naming Conventions" on page 22.

The rack leader controller (leader node) and system admin controller (admin node) are described in the section that follows ("System Nodes" on page 8).

Chassis Manager

Figure 1-2 on page 7 shows chassis manager cabling.

Note: All nodes reside in the Altix ICE custom designed rack. Figure 1-2 on page 7 and Figure 1-3 on page 12 show how systems are cabled up prior to shipment. These figures are meant to give you a functional view of the Altix ICE hierarchical design. They are not meant as cabling diagrams.

The chassis manager in each rack connects to the leader node in its own rack and also the chassis manager in the adjacent rack. The system admin controller (admin node) connects to one CMC in the rack. The system admin controller accesses the BMC on each compute node in the rack via VLAN running over a Gigabit Ethernet (GigE) connection (see Figure 1-7 on page 19).

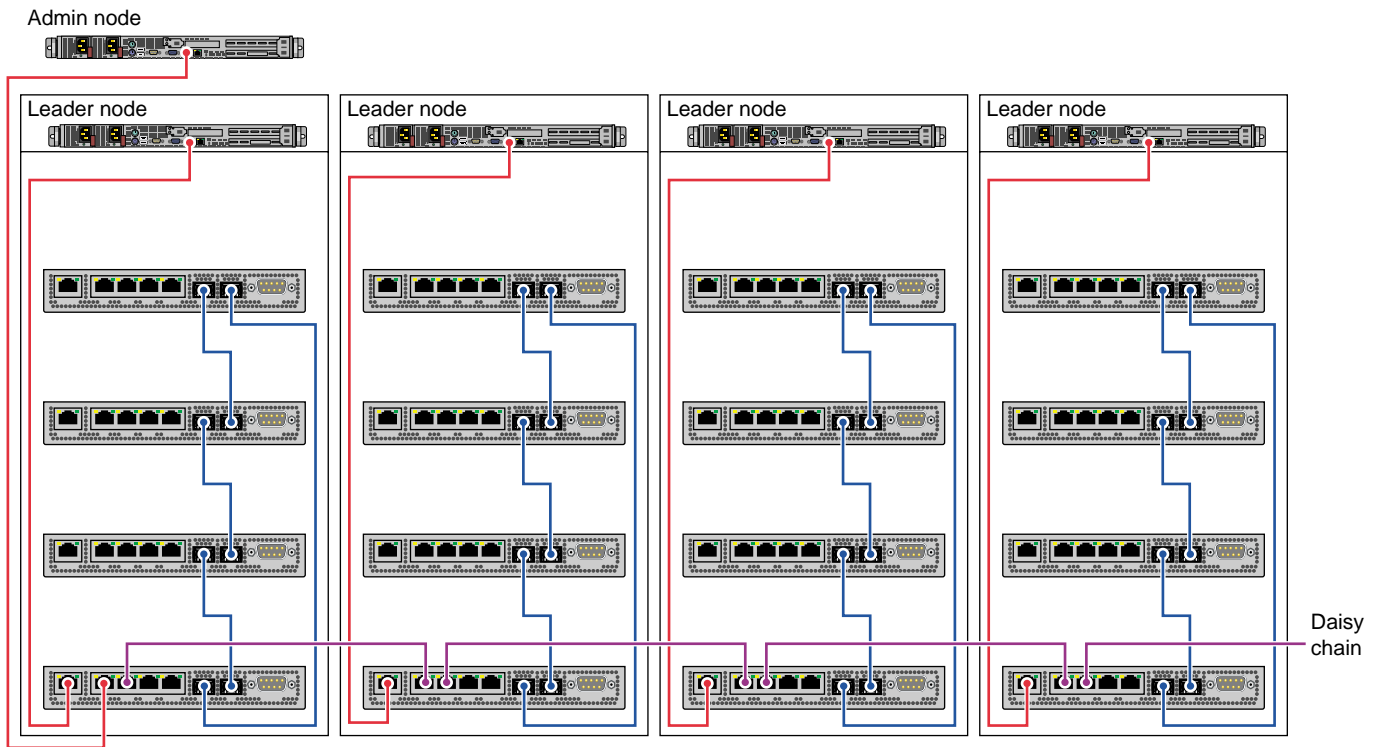

Figure 1-2 Chassis Manager Cabling

Figure 1-3 on page 12 shows cabling for a service node and storage service node (NAS cube).

System Nodes

This section describes the system nodes that are part of SGI Altix ICE 8200 system and covers the following topics:

- "System Admin Controller" on page 8
- "Rack Leader Controller" on page 9
- "Chassis Management Control (CMC) Blade" on page 9
- "Compute Node" on page 10
- "Individual Rack Unit" on page 11
- "Login Service Node" on page 11
- "Batch Service Node" on page 11
- "Gateway Service Node " on page 11
- "Storage Service Node " on page 12

System Admin Controller

The system admin controller (admin node), is used by a system administrator to provision (install) and manage the SGI Altix ICE 8200 system using SGI Tempo systems management software. There is only one system admin controller per SGI Altix ICE 8200 system, as shown in Figure 1-2 on page 7 and it cannot be combined with any other nodes. A GigE connection provides the network connection between the admin node, leader nodes, and service nodes. Communication to and from the CMC and compute blades from the admin node is controlled by VLANs to reduce network traffic bottlenecks in the system. The system admin controller is used to provision and manage the leader nodes, compute nodes and service nodes. It receives and holds aggregated Tempo management data from the leaders node. The admin node is an appliance node. It always runs software specified by SGI.

Rack Leader Controller

The rack leader controller (leader node) is used to manage the nodes in a single rack. The rack leader controller is provisioned and functioned by the system admin controller (admin node). There is one leader node per rack, as shown in Figure 1-2 on page 7. A GigE connection provides the network connection to other leader nodes and to first IRU within its rack as shown in Figure 1-3 on page 12 and Figure 1-4 on page 14. An InfiniBand fabric connects it to the compute nodes within its rack and compute nodes in other racks. The leader node is an appliance node. It always runs software specified by SGI. The rack leader controller (leader node) does the following:

- Runs the fabric management software to monitor and function the InfiniBand fabric on one or more leader nodes in your Altix ICE system
- Monitors and processes data from the IRUs within its rack
- Monitors and processes data from compute nodes within its rack
- Consolidates and forwards data from the IRUs and compute nodes within its rack to the admin node upon request
- Provides a shared, read-only kernel image and `initrd` image and a root filesystem for the compute nodes in its rack
- Provides non-shared, read-write system storage (for `/var`, `/etc` and `/root`) and a minimal swap space for the compute nodes within its rack

The leader node can contain multiple images for the compute nodes. "Customizing Software On Your SGI Altix ICE System" on page 134 describes how you can clone and customize compute node images.

Chassis Management Control (CMC) Blade

Note: The following CMC description is the same as the information presented in "Basic System Building Blocks" on page 1.

Each IRU has a one chassis management control (CMC) blade located directly below compute blade slot 0 as shown in Figure 1-1 on page 2. This is the chassis manager that performs environmental control and monitoring of the IRU. The CMC controls master power to the compute blades under direction of the rack leader controller (leader node).

Note: Setting the circuit breakers on the power distribution units (PDUs) to the "On" position will apply power to the IRU and will start the chassis manager in each IRU. Note that the chassis manager in each IRU stays powered on as long as there is power coming into the unit. Turn off the PDU breaker switch that supplies voltage to the IRU if you want to remove all power from the unit. For detailed information about powering your system on or off, see the "Powering the System On and Off" section in chapter 1 of the *SGI Altix ICE 8200 Series System Hardware User's Guide*.

The leader node can also query the CMC for monitored environmental data (temperatures, fan speeds, and so on) for the IRU. Power control for each blade is handled by the Baseboard Management Controller (BMC) also under direction of the rack leader controller. Once the leader node has asked the CMC to enable master power, the leader node can then command each BMC to power up its associated blade. The leader node can also query each BMC to obtain some environmental and error log information about each blade.

Compute Node

Figure 1-1 on page 2 shows an IRU with 16 compute nodes. Users submit MPI jobs to run in parallel on the Altix ICE system compute nodes using a public network connection via the service node. The service node provides login services and a batch scheduling service, such as PBS Professional (PBSPro 9.x), as shown in Figure 1-4 on page 14. The compute nodes are controlled and monitored by the leader node for their rack as shown in Figure 1-2 on page 7. Compute nodes are booted and mount the shared, read-only portion of the root file system from the rack leader controller (leader node). The leader node provides the network connections to the compute nodes in the same rack and to leader nodes in other rack that then provide the network connections to the compute nodes in their racks. These network connections are via the InfiniBand fabric. The system admin controller does not communicate directly with the CMC or compute blades. Actions for the CMC and compute blades are sent to the appropriate leader node, which communicates to the appropriate CMC and compute blades. The compute nodes do not communicate directly to the CMC or admin nodes, or leader nodes outside their rack.

Generally, the CMC controller is not meant to be accessed directly by system administrators, however, in some situations you may need to access it to change a configuration using the CMC interface LCD panel. For example, in a single IRU system, you may need more Ethernet ports for service node or NAS cube connections. You can adjust the CMC to use the **R58** jack or the **L58** jack for this purpose (see

Figure 1-5 on page 15). For more information on these jacks, see "Gigabit Ethernet (GigE) and 10/100 Ethernet Connections" on page 15.

For information on the CMC interface LCD panel, see chapter 1 and chapter 6 of the *SGI Altix ICE 8200 Series System Hardware User's Guide*.

Individual Rack Unit

The individual rack unit (IRU) is one of the basic building blocks of the SGI Altix ICE 8200 system as shown in Figure 1-1 on page 2. It is described in detail in "Basic System Building Blocks" on page 1.

Login Service Node

The login service node allows users to login into the system to create, compile, and run applications. The login node is usually combined with batch and gateway service nodes for most configurations. The login service node is connected to the Altix ICE system via the InfiniBand fabric and GigE to the public customer network as shown in Figure 1-4 on page 14. Additional login service nodes can be added as the total number of user logins grow.

Batch Service Node

The batch service node provides a batch scheduling service, such as PBS Professional. It is commonly combined with login and gateway service nodes for most configurations. It is connected to the Altix ICE system via the InfiniBand fabric and GigE to the public customer network. This node may be separated from gateway and/or login nodes to scale for large configurations or to run multiple batch schedules.

Gateway Service Node

The gateway service node is the gateway from the InfiniBand fabric to services on the public network such as storage, lightweight directory access protocol (LDAP) services, and file transfer protocol (FTP). Typically, it is combined with the login/batch service node. This node may be separated from login and/or batch nodes to scale for large configurations.

Storage Service Node

The storage service node is a network-attached storage (NAS) appliance bundle that provides InfiniBand attached storage for the Altix ICE system. There can be multiple storage service nodes for larger Altix ICE system configurations. Figure 1-3 on page 12 shows a service node and a storage service node (NAS cube).

Note: All nodes reside in the Altix ICE custom designed rack. Figure 1-2 on page 7 and Figure 1-3 on page 12 show how systems are cabled up prior to shipment. These figures are meant to give you a functional view of the Altix ICE hierarchical design. They are not meant as cabling diagrams.

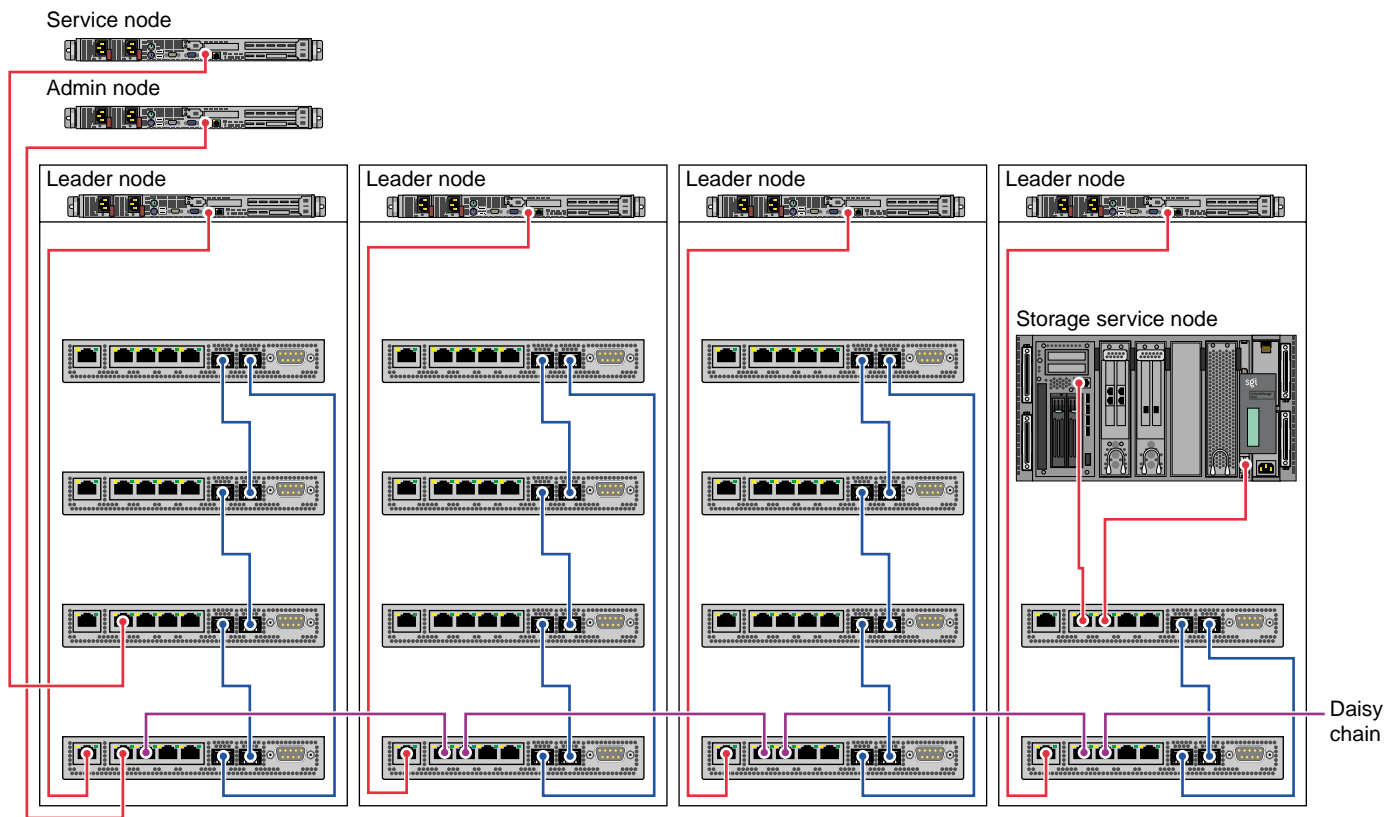

Figure 1-3 Service Nodes

Networks

This section describes the Gigabit Ethernet (GigE) and 10/100 Ethernet connections and the InfiniBand fabric in an SGI Altix ICE 8200 system and covers the following topics:

- "Networks Overview" on page 13
- "Gigabit Ethernet (GigE) and 10/100 Ethernet Connections" on page 15
- "VLANs" on page 17
- "InfiniBand Fabric" on page 21

Networks Overview

This section describes the various network connections in the SGI Altix ICE 8200 system. Users access the system via a public network through services nodes such as the login node and the batch service node, as shown in Figure 1-4 on page 14. A single service node can provide both login and batch services.

System administrators provision (install software) and manage the Altix ICE system via the logical VLAN network running over the GigE connection (see Figure 1-6 on page 18, Figure 1-7 on page 19, and Figure 1-8 on page 20). The system admin controller (admin node) is on the house network (public network) and you access it directly.

The rack leader controller (leader node) provides boot and root filesystem images for the compute nodes in the same rack. The leader node is connected to blades in its rack via the GigE VLAN. It is connected to all service nodes and all other leader nodes via the InfiniBand fabric. Leader nodes have access to compute nodes in other racks via the leader node in that rack.

The gateway service node is the gateway from the InfiniBand fabric to services such as storage, lightweight directory access protocol (LDAP) services, file transfer protocol (FTP), and so on, on the public network. Typically, it is combined with the login/batch service node.

The system admin controller (admin node) and service nodes communicate with the leader node over a GigE fabric that has logically separate, virtual local area networks (VLANs). This GigE fabric is embedded in the backplane of each IRU. This GigE fabric electrically connects much of the Altix ICE system (see Figure 1-4 on page 14).

Users access compute nodes strictly from the service nodes. Jobs are started on compute nodes using commands on the service node, such as, the OpenSSH client remote login program `ssh(1)`, the submit a script to create a batch job `qsub(1)` command, or the Cluster Command Control (C3) tool `cexec(1)` utility that enables the execution of any standard command on all Altix ICE system nodes.

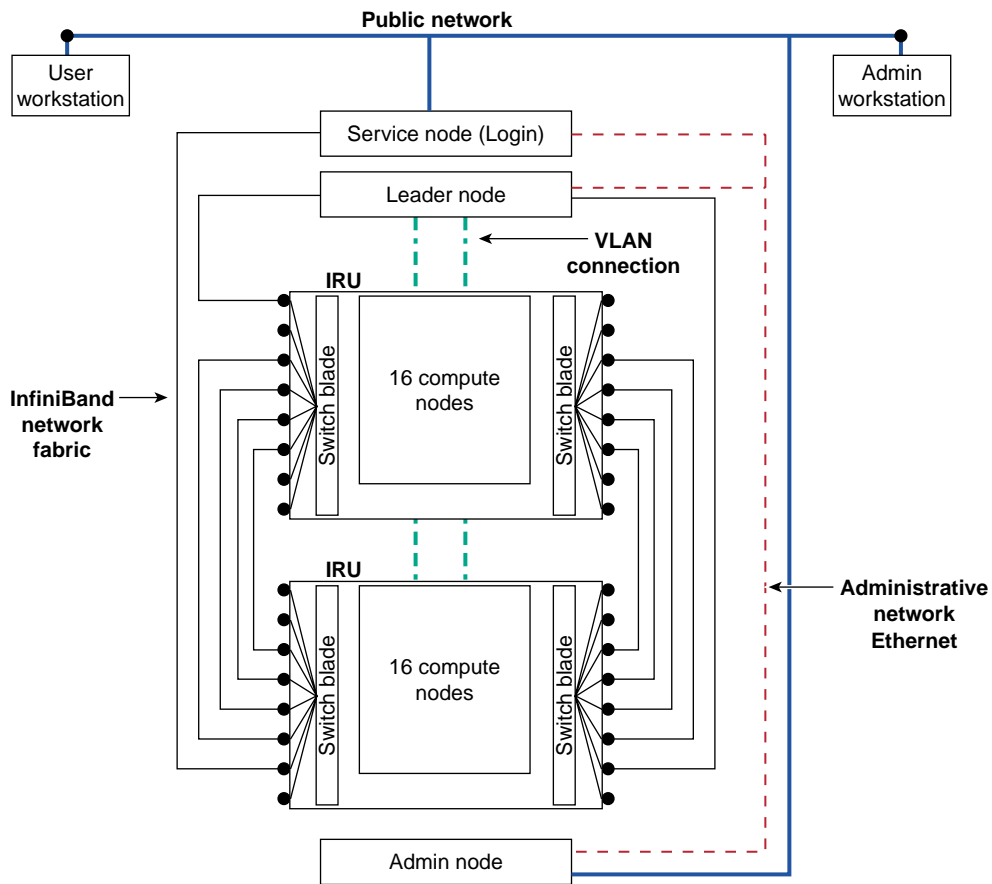

Figure 1-4 Network Connections In a System With Two IRUs

You can use the interconnect verification tool (IVT) to verify that all the various 10/100 Ethernet, Gigabit Ethernet (GigE), and InfiniBand (IB) network links between the various system admin controllers (admin nodes), such as the admin or login node,

the leader node, the compute nodes, the CMC and the BMC nodes are correctly connected and working properly after a system is installed or for maintenance purposes. For more information on IVT, see "Inventory Verification Tool" on page 236.

Gigabit Ethernet (GigE) and 10/100 Ethernet Connections

The SGI Altix ICE 8200 system has several Ethernet networks that facilitate booting and managing the system. These networks are built onto the backplane of each IRU for connection to the compute blades and transverse cables between IRUs and between racks. Each compute blade has a Gigabit Ethernet (GigE) and 10/100 Ethernet connection to the backplane.

The GigE connection is an interface that is accessible to the operating system and the basic input/output (BIOS) running on the blade. It is the interface over which the BIOS uses the preboot execution environment (PXE) to PXE boot and it is known as `eth0` on the configured node.

The 10/100 Ethernet interface is accessible to the management interface (BMC) built onto each compute blade. The operating system running on the blade cannot directly access this 10/100 interface. It belongs to the processor on the BMC. Likewise, the BMC cannot access the GigE interface.

Figure 1-5 on page 15 shows a more detailed view of the Chassis manager.

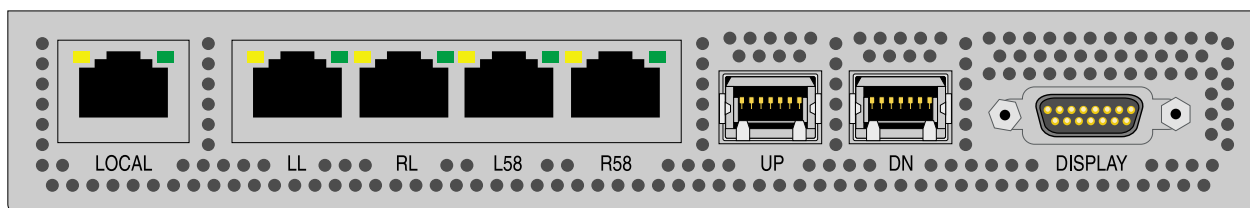

Figure 1-5 Chassis Manager

The chassis management control (CMC) blade has two embedded Ethernet switches. One is a 24-port GigE switch and the other a 24-port 10/100 switch. The 10/100 switch is a sub-switch, hanging off one port, of the GigE switch.

The primary GigE interface from each of sixteen blades connects to the GigE switch and the sixteen blade BMCs connect to the 10/100 switch. The GigE connections also connect the service nodes, including the service storage nodes.

The GigE switches in each IRU are "stacked" using a special stacking connection between each IRU in a rack. This connection runs a special intra-switch protocol. All switches in a rack are ganged together to form one large 96 port switch. The connections from each CMC to another are labeled **UP** and **DN** as shown in Figure 1-5 on page 15. The switches are stacked in a ring so failure of one link still allows traffic to flow in the opposite direction on the ring.

The processor on the CMC manages these switches effectively forming a large, intelligent Ethernet switch. A VLAN mechanism runs on top of this network to allow management control software to query port statistics and other port metrics including the attached peer's MAC address.

The CMC has five additional RJ45 connections on its front panel as shown in Figure 1-5 on page 15. The function of these jacks is, as follows:

- **Local**

This is a connection to the leader node at the top of the rack in which this CMC is located. Only one CMC (of the possible four) is connected to the leader node, as shown in Figure 1-2 on page 7.

- **LL**

Used to connect service nodes and service storage nodes. The RL jack in the far left CMC connects to the LL jack of the right adjacent CMC to create or grow the Ethernet network. Figure 1-2 on page 7 shows this daisy chaining.

- **RL**

Used to connect service nodes and service storage nodes. The RL jack in the far left CMC connects to the LL jack of the right adjacent CMC to create or grow the Ethernet network. Figure 1-2 on page 7 shows this daisy chaining.

- **L58**

This is a connection for the IEEE 1588 timing protocol from this CMC to the one immediately to the left. If this is the left-most rack, this jack is unconnected.

- **R58**

This is a connection for the IEEE 1588 timing protocol from this CMC to the one immediately to the right. If this is the right-most rack, this jack is unconnected.

A NAS cube storage service node uses both the **LL** and **RL** jacks to connect to the Altix ICE system as shown in Figure 1-3 on page 12.

For small, one IRU configurations, the **L58** and **R58** ports (see Figure 1-5 on page 15) can be used to connect service nodes. This functionality can be enabled using the LCD panel of the CMC. It can also be done in the factory or by your SGI system support engineer (SSE).

VLANs

Several virtual local area networks (VLANs) are used to isolate Ethernet traffic domains within the cluster. The physical Ethernet is a shared network that has a connection to every node in the cluster. The admin node, leader nodes, service nodes, compute nodes, CMCs, BMCs, all have a connection to the Ethernet. To isolate the broadcast domains and other traffic within the cluster, VLANs are used to partition it and are, as follows:

- VLAN_1588

Includes all `1588_left` and `1588_right` connections, as well as an internal port to the CMC processor. This VLAN carries all of the IEEE 1588 timing traffic.

- VLAN_HEAD

Includes all `leader_local`, `leader_left`, and `leader_right` connections. The `VLAN_HEAD` VLAN connects the admin node to all of the leader nodes (including the leader nodes' BMCs) and the service nodes.

- VLAN_BMC

Includes all 10/100 sub-switches and the `leader_local` ports. The `VLAN_BMC` VLAN connects the leader nodes to all of the BMCs on the compute blades and to the CMCs within each IRU. See Figure 1-6 on page 18.

- VLAN_GBE

Includes all GigE blade ports and the `leader_local` port. The `VLAN_GBE` VLAN connects the leader nodes to the GigE interfaces of all the compute blades. See Figure 1-6 on page 18.

`VLAN_GBE` and `VLAN_BMC` do not extend outside of any rack. Therefore, traffic on those VLANs stays local to each rack.

Only `VLAN_HEAD` extends rack to rack. It is the network used by the admin node to communicate to the leader node of each rack and to each service node.

The rack leader controllers (leader nodes) must run 802.1Q VLAN protocol over their downstream GigE connection to the CMC and the CMC LL port must also run 802.1Q. This is done for you when the rack leader controllers are installed from the system admin controller. For more information, see "Installing Software on the System Admin Controller" on page 31. Each VLAN should present itself as a separate, pseudo interface to the operating system kernel running on that leader node. VLAN_HEAD, VLAN_BMC, and VLAN_GBE must all transition the single Ethernet segment which connects the leader to the CMC in the rack below it.

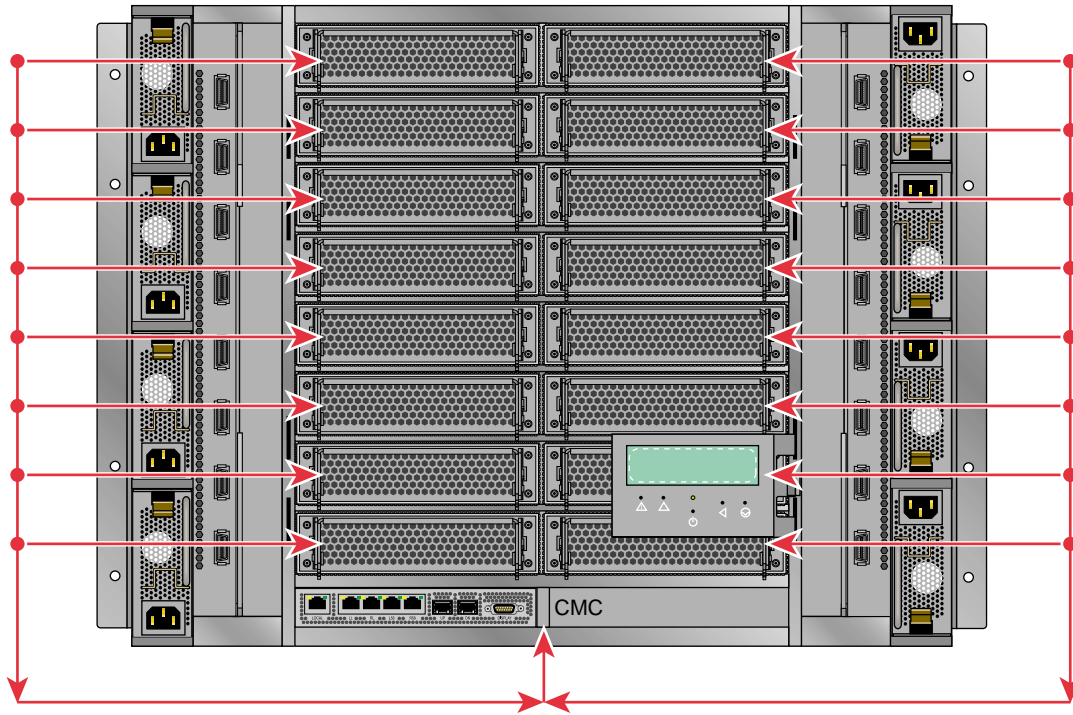

Figure 1-6 VLAN_GBE and VLAN_BMC Network Connections - IRU View

The VLAN_GBE and VLAN_BMC networks connect the leader node in a given rack with the compute nodes (blades). In the case of VLAN_BMC, the network also connects the CMC with the compute blades and rack leader controller (leader node).

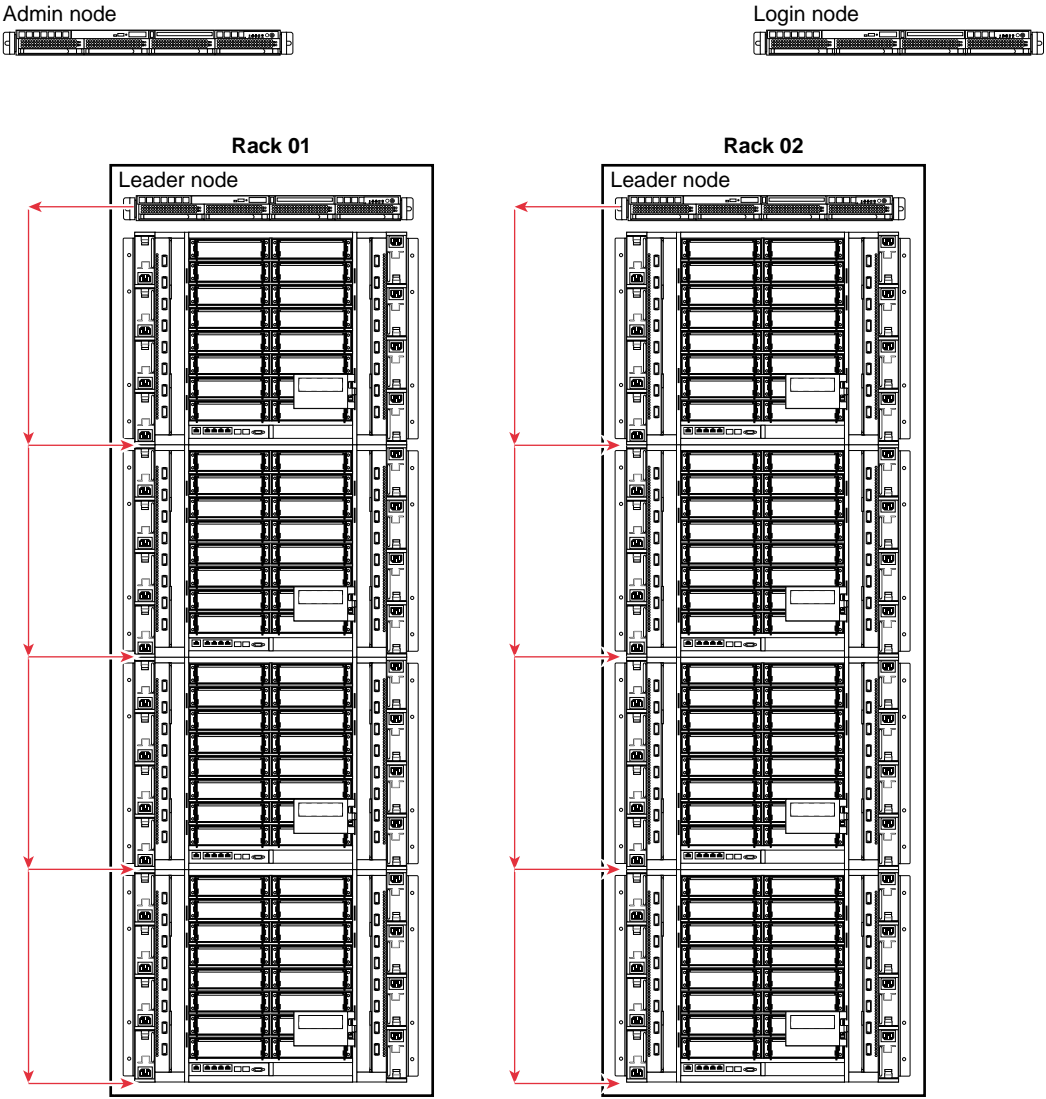

Figure 1-7 VLAN_GBE and VLAN_BMC Network Connections – Rack View

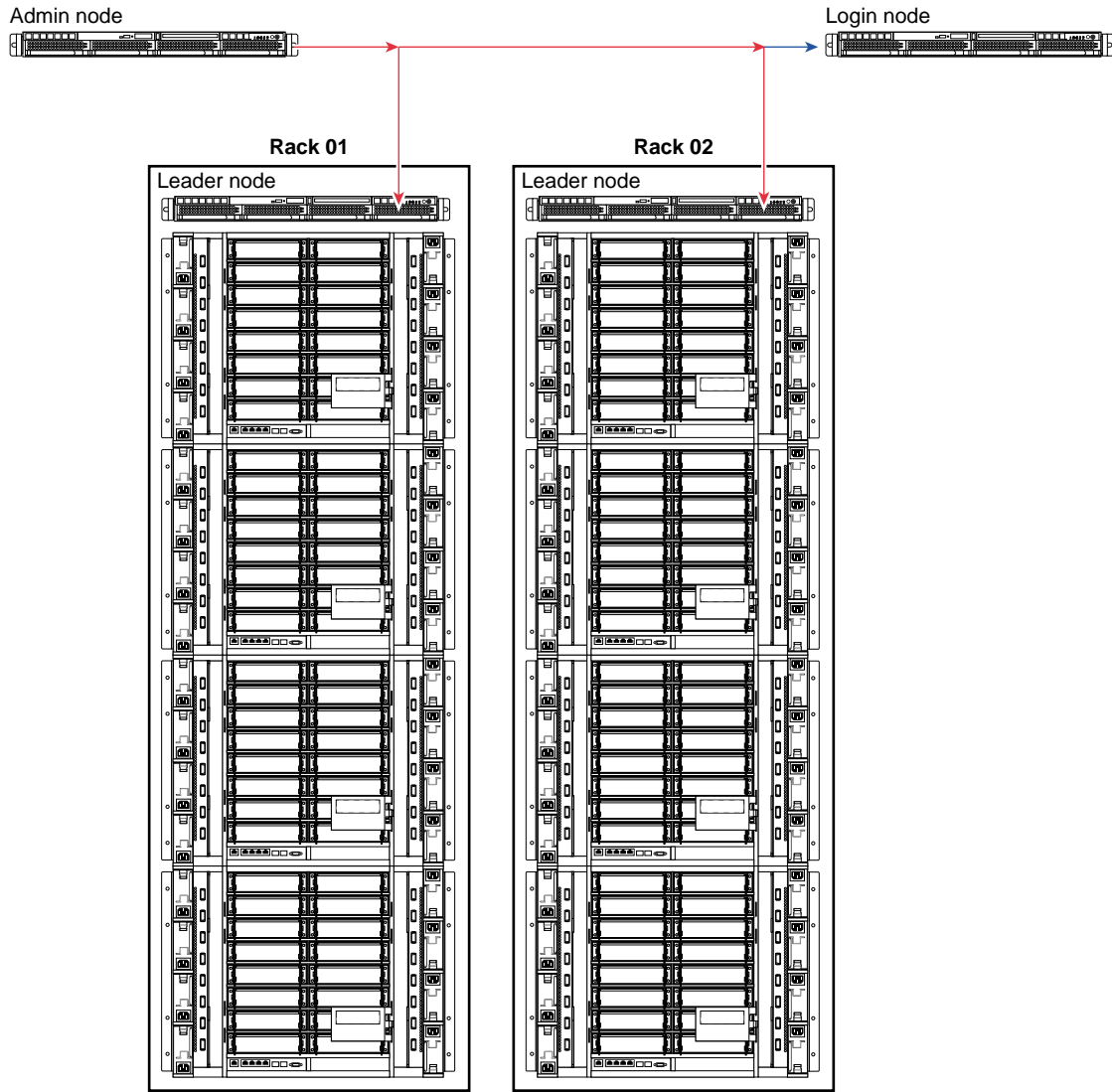

Figure 1-8 VLAN_HEAD Network Connections

In an SGI Altix ICE system with just one IRU, the CMC's R58 and L58 ports are assigned to VLAN_HEAD by a field configurable setting. This provides two additional

Ethernet ports that can be used to connect service nodes to your system. This is done in the factory or by your SGI system support engineer (SSE).

For information on the CMC interface LCD panel shown just about the CMC in Figure 1-6 on page 18, see chapter 1 and chapter 6 of the *SGI Altix ICE 8200 Series System Hardware User's Guide*.

InfiniBand Fabric

The InfiniBand fabric connects the service nodes, leader nodes, and the compute blades. It does not connect to the admin node or the CMCs. The InfiniBand network has two separate network fabrics, `ib0` and `ib1`. The host channel adapter (HCA) in the leader node has two ports that connect separately to the bottom IRU in the rack.

Each IRU has two 24-port switches (see Switch blade in Figure 1-9 on page 22). Each switch is on a separate fabric.

On each switch, 16 ports go to the 16 compute blades. Each compute blade has two InfiniBand ports, and each port connects to a different fabric. Therefore, both switches connect to each blade.

Of the remaining eight ports on each switch, currently six of them are used to connect to either IRUs in the same rack or to IRUs in other racks. One port of one IRU in a rack (usually the first IRU) connects to the leader node in that rack.

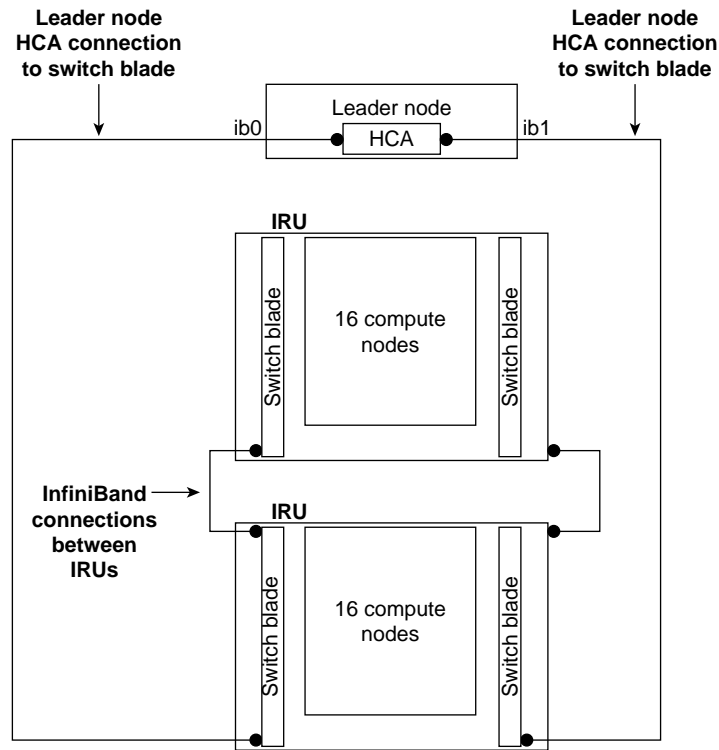

Figure 1-9 Two InfiniBand Fabrics in a System with Two IRUs

Network Interface Naming Conventions

As described in "Networks" on page 13, you can think of an SGI Altix ICE 8200 system as having two distinct networks, the connections between the admin nodes, service nodes, and leader nodes, and the connections between the compute blades, CMCs, and the leader node within each rack. In general, these connections are made over one of the VLAN networks described in "VLANs" on page 17, but it is useful to be able to specify over which interface (VLAN) you are attempting to communicate. This section describes the naming strategy for logical type of interface being used. It covers the following topics:

- "System Component Names" on page 23
- "VLAN_Head Network Connections" on page 23

- "VLAN_GBE Network Connections" on page 24
- "VLAN_BMC Network Connections" on page 25
- "VLAN_1588 Network Connections" on page 25
- "Non-resolvable Names" on page 26
- "Hostnames" on page 26
- "InfiniBand Network" on page 28

System Component Names

Even though you may be communicating on different VLANs, you may in fact be communicating with the same physical network interface on the system. Naming the logical connections by function allows flexibility to change the number or type of the underlying physical networks. At the topmost level, the admin and service node nodes can communicate with the leader nodes over the `VLAN_HEAD` virtual network. The system component terms used in this section are described, as follows:

Node	Refers to a building block within an SGI Altix ICE 8200 system (see "System Nodes" on page 8)
Connection name	Denotes a resolvable name associated with an IP network
Node name	Represents system-wide unique identifier for the building blocks of the SGI Altix ICE 8200 system. These IDs are partly not routable. See "Non-resolvable Names" on page 26.
Hostname	Returns string of the hostname command. Is technically independent from the other names.

System-wide unique names are node names and non-resolvable names.

X, Y, and Z in the following tables in this section are all integers.

VLAN_Head Network Connections

Table 1-1 on page 24 shows the `VLAN_Head` network connection names. See Figure 1-8 on page 20.

Table 1-1 VLAN_HEAD Connections

Node	Connection Name
Admin	admin
Service	serviceX serviceX-bmc
Leader	rXlead rXlead-bmc

There is one admin node per system. You can have multiple service nodes labelled `service0`, `service1`, and so on. The BMC controllers for managed service nodes are accessible inside the network. BMCs for unmanaged service nodes are normally configured on the external network. For more information on managed service nodes, see "Installing Software on the Rack Leader Controllers and Service Nodes" on page 72.

VLAN_GBE Network Connections

Table 1-2 on page 24 shows the VLAN_GBE network connections.

Table 1-2 VLAN_GBE Network Connections.

Node	Connection Name	Node Name
Leader	lead-eth	rXlead
CMC	iYc	rXiYc
Blade	iYnZ-eth	rXiYnZ

The GBE VLAN is entirely internal to each rack (see Figure 1-6 on page 18). The naming scheme is replicated between each rack, so the name `i2n4-eth` (identifying the VLAN_GBE interface on IRU 2, node 4) may match several different nodes, but only ever one in each rack. To identify a node uniquely, use the `rXiYnZ` syntax.

When more than one GigE interface is present, the names `lead-eth1`, `iYnZ-eth1`, and so on, may be used.

VLAN_BMC Network Connections

Table 1-3 on page 25 shows the `VLAN_BMC` network connections.

Table 1-3 `VLAN_BMC` Network Connections

Node	Connection Name	Node Name
Leader	<code>lead-bmc</code>	<code>rXlead</code>
CMC	<code>iYc</code>	<code>rXiYc</code>
Blade	<code>iYnZ-bmc</code>	<code>rXiYc</code>

The BMC VLAN is also local to each rack, in the same way as the GBE VLAN (see Figure 1-6 on page 18).

Note that the interface `lead-bmc` on the leader node is not an interface to the BMC on the leader, but rather is an interface on the leader to the `VLAN_BMC` network in that leaders rack. Software running on other nodes in an Altix ICE system, outside of a given rack, cannot directly address the BMC's, or CMC, within said rack. Rather such requests much go through suitable application level software running on that rack's leader, when can in turn access the BMCs and CMC in its rack, via this `lead-bmc` interface to the racks `VLAN_BMC` network.

Connecting to the leader node's BMC is only possible from an admin node, service, or other leader node, when you should use `rXlead-bmc`.

The CMC does not have a BMC connection, but instead the `VLAN_BMC` connection is to the CMC's console interface.

VLAN_1588 Network Connections

Table 1-4 on page 26 shows the `VLAN_1588` network connections.

Table 1-4 VLAN_1588 Network Connections

Node	Connection Name	Node Name
CMC	rXiYc-1588	rXiYc-1588

The 1588 VLAN carries the time synchronization traffic and connects CMCs in all the racks in the Altix ICE system. For this reason, the full rack-qualified name is needed to uniquely identify the target CMC.

Non-resolvable Names

Sometimes a rack, an IRU, a blade (node), or a CMC needs to be uniquely identified within the Altix ICE system. Table 1-5 on page 26 shows the names that may be used for this, but there is no IP address associated with them. Therefore, DNS lookup will not succeed for these names. The names are used by certain Altix ICE management tools and are parsed internally to indicate which leader node to use in order to connect to the destination system.

Table 1-5 Non-resolvable Names

Node	Node Name
Rack	rX
IRU	rXiY
Blade	rXiYnZ
CMC	rXiYc

Hostnames

Hostnames are distinct from the non-resolvable names and are shown in Table 1-6 on page 27. In general, this is the name that you get by typing hostname at the command prompt on the system, and is used as a way of identifying the system to the user. Often, the command prompt is set up to contain the hostname. This is a

benefit since with multiple windows open to different systems, it allows the user to avoid executing commands in the wrong window.

Table 1-6 Hostnames

Node	Hostnames
Admin	user assigned
Leader	rXlead
Blade	rXiYnZ
CMC	rXiYc
Service	user assigned (see Note below)

Note: By default, the host name for service nodes follow the convention serviceX. However, host names of service nodes can be changed using the `cadmin` command (see "`cadmin: SGI Tempo Administrative Interface`" on page 165).

For the SGI Tempo v1.4 release and later, the internal domain name service (DNS) has changed. The hostname gets the A record and name `-ib0` gets a CNAME alias. Additionally, if you changed the hostname from the SGI Tempo node name, there will be CNAME alias for the SGI Tempo node name, as well.

The zone looks similar to the following:

```

r1lead          IN      A       10.148.0.1
r1lead-ib0     IN      CNAME   r1lead.ice.mycompany.com.
r1lead-ib1     IN      A       10.149.0.1
r1i0n0         IN      A       10.148.0.2
r1i0n0-ib0    IN      CNAME   r1i0n0.ice.mycompany.com.
r1i0n0-ib1    IN      A       10.149.0.2
r1i0n1         IN      A       10.148.0.3
r1i0n1-ib0    IN      CNAME   r1i0n1.ice.mycompany.com.
r1i0n1-ib1    IN      A       10.149.0.3
[...]
```

In the example above, the node/hostname gets the A record. The `-ib0` name is a CNAME alias to the node/hostname. `ib1` remains same as previous releases.

InfiniBand Network

The InfiniBand fabric is connected to service nodes, rack leader controllers (leader nodes), and compute nodes, but not to the system admin controller (admin node) or CMCs. Table 1-7 on page 28 shows InfiniBand names. There are two IB connections to each of the nodes that use it. Since IB is not local to each rack, you must use the fully-qualified, system-unique node name when specifying a destination interface. It may be necessary to alias the `rXiYnZ` names (currently non-resolvable) to `rXiYnZ-ib0` if this is needed by MPI. Technically, `rXiYnZ` from a leader node points at the `VLAN_GBE` interface for the compute blade while from a service or compute blade, `rXiYnZ` points to the `ib0` interface.

For the SGI Tempo 1.4 release, in DNS the `rXiYnZ` name is the A record, with the `-ib0` address, `rXiYnZ-ib0`, the CNAME alias to the `rXiYnZ` A record. The same applies to service nodes (see "Hostnames" on page 26).

If you change the node name, the new name is the A record, with the `-ib0` address, `newname-ib0`, the CNAME alias to the new name A record. The old name is a CNAME alias to the new name A record.

Table 1-7 InfiniBand Names

Node	Connection Name	Node Name
Service	<code>serviceX-ib0</code> <code>serviceX-ib1</code>	<code>serviceX</code>
Leader	<code>rXlead-ib0</code> <code>rXlead-ib1</code>	<code>rXlead</code>
Blade	<code>rXiYnZ-ib0</code> <code>rXiYnZ-ib1</code>	<code>rXiYnZ</code>

Note: The host name of a service node can be changed from the default.

System Discovery, Installation, and Configuration

This chapter describes how to use the SGI Tempo systems management software to discovery, install, and configure your Altix ICE system and covers the following topics:

- "Configuring Factory-installed SGI Altix ICE System" on page 30
- "Overview of Installing Software and Configuring Your SGI Altix ICE System" on page 31
- "Installing Software on the System Admin Controller" on page 31
- "discover Command" on page 68
- "Installing Software on the Rack Leader Controllers and Service Nodes" on page 72
- "blademond Command For Automatic Blade Discovery" on page 75
- "Discovering Compute Nodes" on page 76
- "Service Node Discovery, Installation and Configuration" on page 77
- "InfiniBand Configuration" on page 77
- "Configuring the Service Node" on page 80
- "Setting Up an NFS Home Server on a Service Node for Your Altix ICE System" on page 86
- "Service Node NFS Server Alternate: Re-exporting House NFS Servers" on page 92
- "RHEL Service Node House Network Configuration " on page 94
- "Setting Up a NIS Server for Your Altix ICE System" on page 95
- "Installing SGI Tempo Patches and Updating SGI Altix ICE Systems " on page 109

Note: If you are upgrading from a prior release or installing SGI Tempo software patches, see "Installing SGI Tempo Patches and Updating SGI Altix ICE Systems " on page 109 and "Upgrading from SGI ProPack 6 SP1 to SGI ProPack 6 SP2" on page 117.

Configuring Factory-installed SGI Altix ICE System

This section describes what you should do if you wish to use the pre-installed software on the system admin controller (admin node).

Procedure 2-1 Configuring Factory-installed SGI Altix ICE System

To configure the pre-installed software that comes on the admin node, perform the following steps:

1. Use YaST to configure the first interface of the admin node for your house network. Settings to adjust may include the following:
 - Network settings including IP, default route, and so on
 - Root password
 - Time zone
2. If you need to adjust SGI Altix ICE settings such as the Altix ICE cluster domain or any internal network ranges, you will need to reset the database and rediscover the leader nodes and service nodes, as follows:
 - a. Start the `configure-cluster` command (see "configure-cluster Command Cluster Configuration Tool" on page 47).
 - b. Choose the **Reset Database** operation. Read the on-screen instructions.
 - c. After the database has been reset, choose **Initial Setup Menu**.
 - d. Start the options in this menu in order starting at **Perform Initial Admin Node Infrastructure Setup**. Note that if you are changing any network ranges or the cluster subdomain, you should choose **Network Settings before** proceeding to **Perform Initial Admin Node Infrastructure Setup**.

Note: You will get a message about the systemimager images already existing. You may choose to use the existing images instead of re-creating them. This will save about 30 minutes. Either choice is OK. Do **not** choose **use existing images** if you changed the root password or time zone as these settings are stored in the image when the image is created.

- e. At this point, you can begin to discover leader and service nodes and continue cluster installation. See "discover Command" on page 68.

Overview of Installing Software and Configuring Your SGI Altix ICE System

This section provides a high-level overview of installing and configuring your SGI Altix ICE system.

Procedure 2-2 Overview of Installing Software and Configuring Your SGI Altix ICE System

To install and configure software on your SGI Altix ICE system, perform the following steps:

1. Follow "Installing SLES on the Admin Node" on page 32 or "Installing RHEL on the Admin Node" on page 43 to install software on your system admin controller (admin node).
2. Follow "configure-cluster Command Cluster Configuration Tool" on page 47 to configure the overall cluster.
3. Follow "Installing Software on the Rack Leader Controllers and Service Nodes" on page 72 to install software on the leader nodes and service nodes.
4. Follow "Discovering Compute Nodes" on page 76 to discover compute nodes.
5. Follow "Service Node Discovery, Installation and Configuration" on page 77 to discover, install and configure service nodes.
6. Ensure that all hardware components of the cluster have been discovered successfully, that is, admin, leader, service, and compute nodes and then follow "InfiniBand Configuration" on page 77 to configure and check the status of the InfiniBand fabric.
7. Follow "Configuring the Service Node" on page 80, "Setting Up an NFS Home Server on a Service Node for Your Altix ICE System" on page 86, "Service Node NFS Server Alternate: Re-exporting House NFS Servers" on page 92, and "Setting Up a NIS Server for Your Altix ICE System" on page 95 to complete your system setup.

Installing Software on the System Admin Controller

This section describes how to install software on the system admin controller (admin node). The system admin controller contains software for provisioning, administering, and operating the SGI Altix ICE 8200 system. The SGI Admin Node Autoinstallation DVD contains a software image for the system admin controller (admin node) and

contains SGI Tempo and SGI ProPack for Linux packages, used in conjunction with the packages from the SLES10 SP2 DVD, to create leader, service, and compute images.

The root image for the admin node appliance is created by SGI and installed on to the admin node using the admin install DVD.

Note: If you are reinstalling the admin node, you may want to make a backup of the cluster configuration snapshot that comes with your system so that you can recover it later. You can find it in the `/opt/sgi/var/ivt` directory on the admin node; it is the earliest snapshot taken. You can use this information with the interconnect verification tool (IVT) to verify that the current system shows the same hardware configuration as when it was shipped. For more information on IVT, see "Inventory Verification Tool" on page 236.

This section covers the following topics:

- "Installing SLES on the Admin Node" on page 32
- "Installing RHEL on the Admin Node" on page 43
- "configure-cluster Command Cluster Configuration Tool" on page 47

Installing SLES on the Admin Node

Procedure 2-3 Installing Software on the System Admin Controller

To install software images on the system admin controller, perform the following steps:

1. Turn on, reset, or reboot the system admin controller. The power on button is on the right of the system admin controller, as shown in Figure 2-1 on page 32.

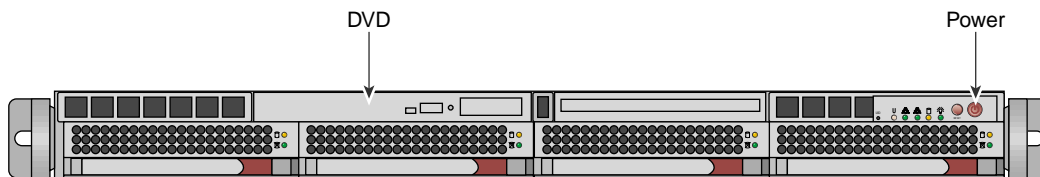

Figure 2-1 System Admin Controller Power On Button and DVD Drive

Prior to the SGI Tempo 1.2 release, the serial console was always used even if the admin node install itself went to the vga screen.

The new method configures the default serial console used by the system to match the console used for installation.

If the you type "serial" at the Admin dvd install prompt, the system is also configured for serial console operations after installation and the `yast2-firstboot` questions appear on the serial console.

If the you hit `Enter` at the prompt or type `vga`, the VGA screen is used for installation, as previously, but also, the system is configured to use VGA as the default console, thereafter.

If a you want to install to the VGA screen, but also want the serial console to be used for operations after initial installation, you should add a `console=` parameter to `/boot/grub/menu.lst` for each kernel line. This is done when the admin node boots for the first time after installation is completed. An example of this is, as follows:

```
kernel /boot/vmlinuz-2.6.16.46-0.12-smp root=/dev/disk/by-label/sgiroot console=ttyS1,38400n8 splash=silent showopts
```

The appropriate entries were added to the `inittab` and `/etc/security`. The change, above, is the only one needed to switch the default console from VGA to serial. Likewise, to move from serial to VGA, simply remove the `console=` parameter, altogether.

2. Insert the SGI Admin Node Autoinstallation DVD in the DVD drive on the left of the system admin controller as shown in Figure 2-1 on page 32.
3. An autoinstall message appears on your console, as follows:

SGI Admin Node Autoinstallation DVD

The first time you boot after installation, you will be prompted for system setup questions early in the startup process. These questions will appear on the same console you use to install the system.

You may optionally append the "netinst" option with an nfs path to an ISO.

Cascading Dual-Boot Support:

`install_slot=:` install to a specific root slot, default 1
`re_partition_with_slots=:` re-partition with number of slot positions, up to 5.
default is 2. Reminder: applies to the whole cluster, not just admin node
`destructive=1:` allow slots with existing filesystems to be re-created
or signify ok to re-partition non-blank disks for `re_partition_with_slots=`

You may install from the vga screen or from the serial console.

The default system console will match the console you used for installation. Type "vga" for the vga screen or "serial" for serial.

Append any additional parameters after "vga" or "serial".

EXAMPLE: `vga re_partition_with_slots=3 netinst=server:/mntpoint/admin.iso`

Note: If you want to use the serial console, enter **serial** at the **boot:** prompt, otherwise, output for the install procedure goes to VGA screen.

It is important to note that the command line arguments you supply to the boot prompt will have implications for your entire cluster including things such as how many root slots are available, and which root slot to install to. Please read "Cascading Dual-Boot" on page 117 before you install the admin node so you are prepared for these crucial decisions.

You can hit the **ENTER** button at the boot prompt. The boot `initrd.image` executes, the hard drive is partitioned creating a swap area and a root file system, the Linux operating system and the cluster manager software is installed and a repository is set up for the rack leader controller, service node, and compute node software RPMs.

Note: When you boot with the admin install DVD, any previous data on the disks is destroyed. This step takes several minutes. When the installation is complete, the system admin controller DVD drive automatically ejects the DVD.

4. Once installation of software on the system admin controller is complete, remove the DVD from the DVD drive.
 5. Once the system has been installed, enter the `reboot` command to reboot your system.
-

Note: The output will go to the VGA screen unless you used **serial** for the admin install DVD earlier.

You will see messages about the system admin controller booting the kernel. You can ignore any messages about a few services that may fail to start.

Note: If you used the serial console for installation (**serial** is not the default), the console output and configuration questions from `yast2 firstboot` will go to the serial port. Pressing `Ctrl -1` will re-draw the `yast2 firstboot` screen when you are using the serial console.

6. After the reboot completes, the YaST first boot installation tool starts and a **Welcome** screen appears, as shown in Figure 2-2 on page 36. Click on the **Next** button to proceed.
-

Note: The **YaST Installation Tool** has a main menu with sub-menus. You will be redirected back to the main menu, at various times, as you follow the steps in this procedure.

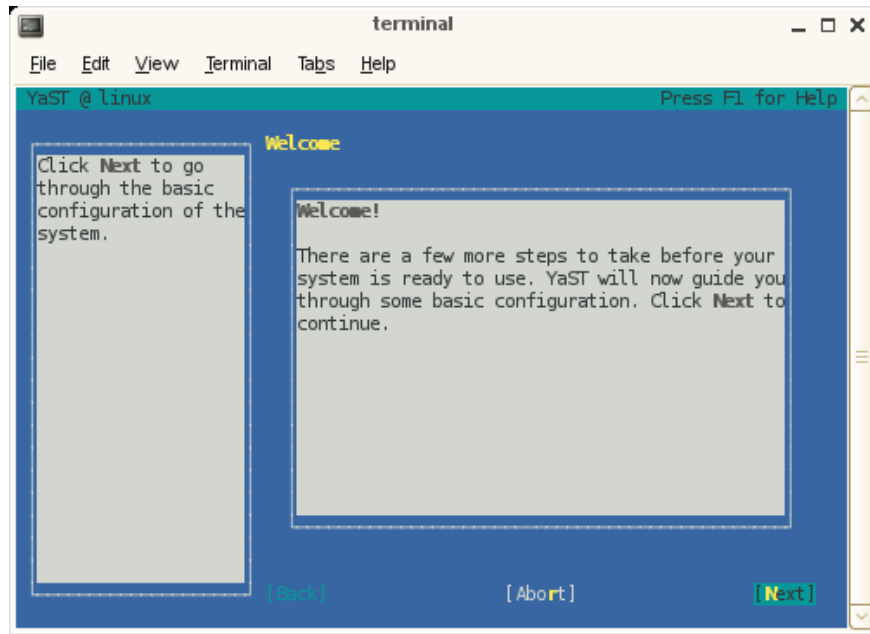

Figure 2-2 YaST **Welcome** Screen

You will be prompted by YaST firstboot installer to enter your system details including the root password, network configuration, time zone, and so on.

7. From the **Hostname and Name Server Configuration** screen, as shown in Figure 2-3 on page 37, enter the hostname and domain name of your system in the appropriate fields. Make sure that **Change Hostname via DHCP** is unselected (no x should appear in the box). Click on the **Next** button to continue.

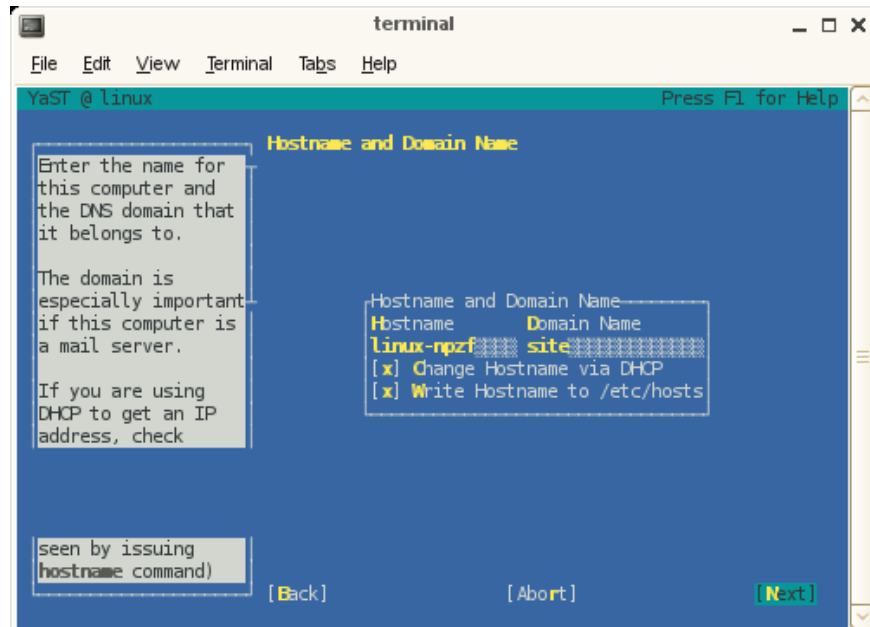

Figure 2-3 Hostname and Name Server Configuration Screen

Note: You can use `Ctrl L` to refresh the YaST screen as necessary.

8. From the **Network Card Configuration Interfaces** screen, shows the suggested configuration as shown in Figure 2-4 on page 38. Click **Next** to continue.

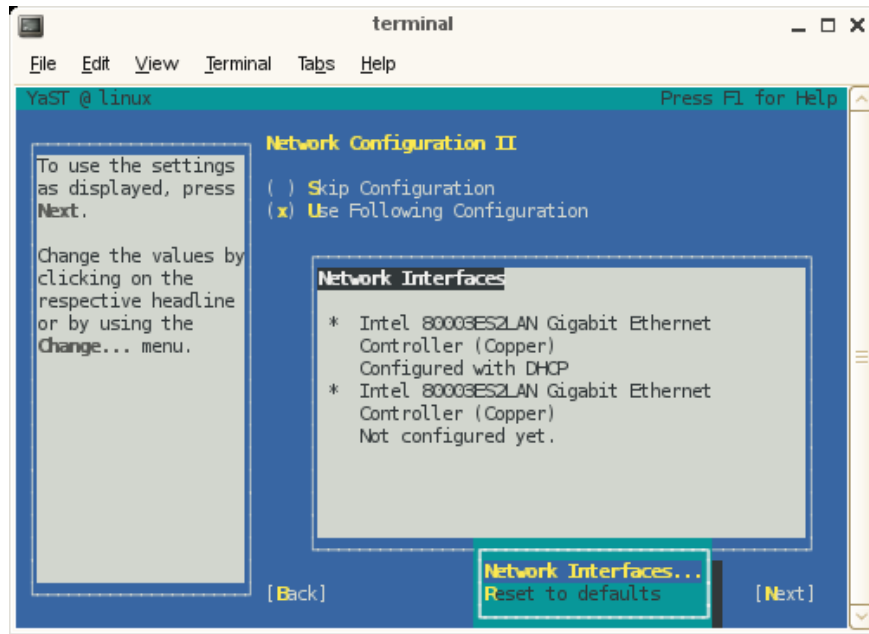

Figure 2-4 Network Card Configuration Interfaces Screen

9. From the **Network Card Configuration Overview** screen, configure the first card under **Name** to establish the public network (sometimes called the house network) connection to your SGI Altix ICE 8200 system.

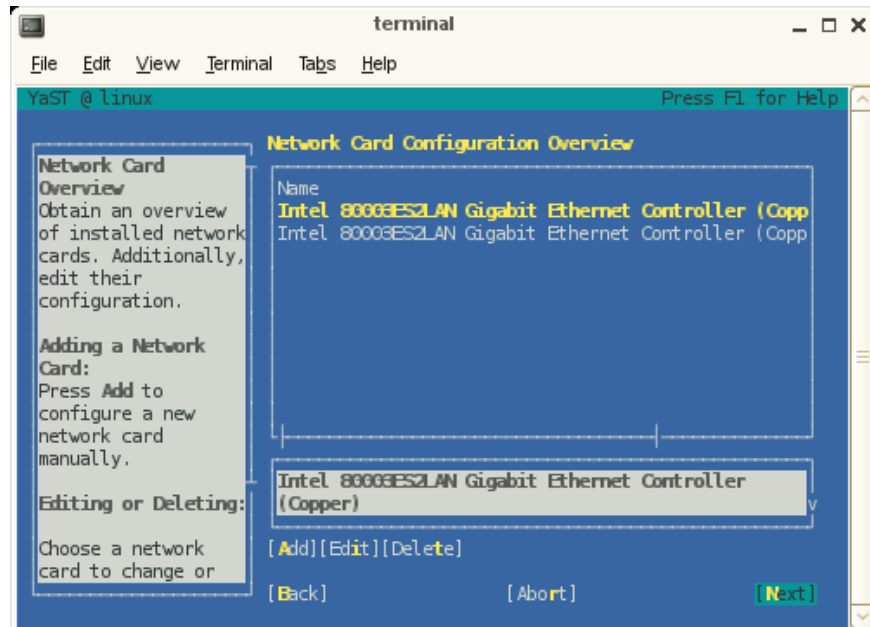

Figure 2-5 Network Card Configuration Overview Screen

Note: Do NOT configure the second interface at this time. A script will do this for you in a later step.

Click on the **Next** button to continue.

10. From the **Network Address Setup** screen, choose dynamic address setup via DHCP or enter the IP address for the system admin controller. This is your public/house network information. Click on the **Next** button to continue.

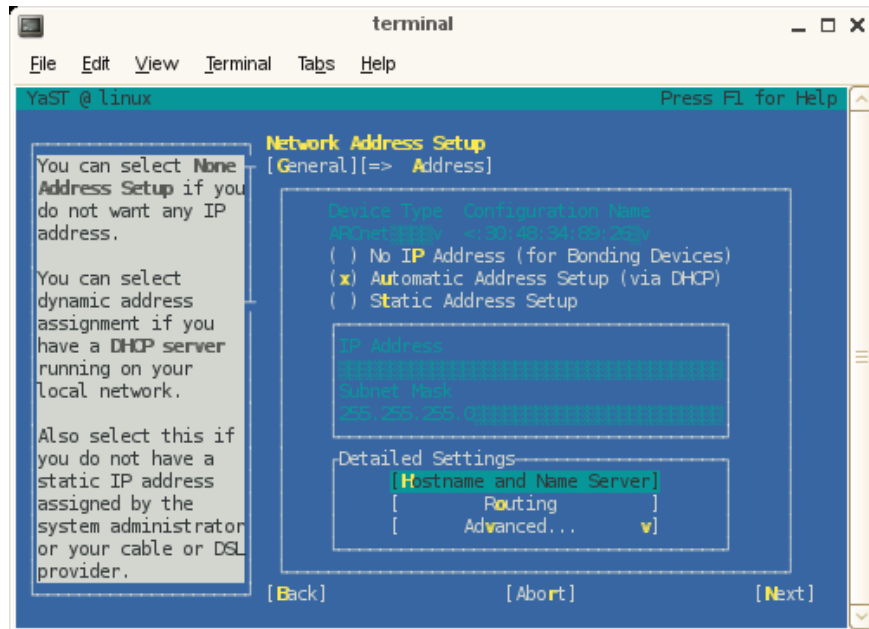

Figure 2-6 Network Address Setup Screen

11. From the **Hostname and Name Server Configuration** screen, enter the name and DNS domain name as shown in Figure 2-7 on page 41. Note that the hostname was entered in step 7.

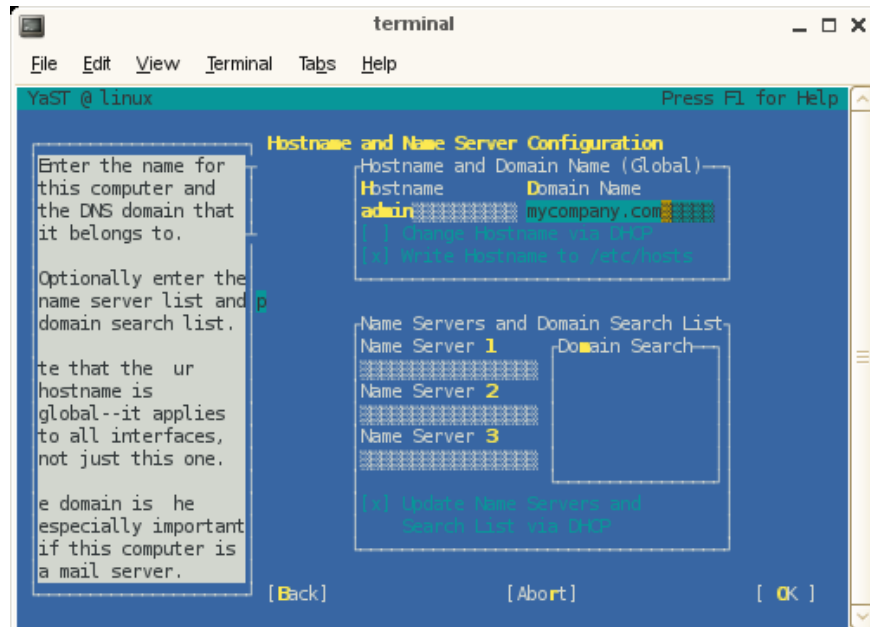

Figure 2-7 Hostname and Name Server Configuration Screen

12. From the **Routing Configuration** screen, enter the appropriate gateway address and netmask. Click on the **OK** button to continue.
13. From the **Clock and Time Zone** screen, select the appropriate region and time zone. Click on the **Next** button to continue.
14. From the **Password for the System Administrator “root”** screen, set the root password. Click on the **Next** button to continue.
15. From the **User Authentication Method** screen, select the authentication method to use for the users on your system. Click on the **Accept** button to continue.
16. Enter the user's full name, username, and user password in the **New Local User** screen. Click on the **Next** button to continue.
17. From the **Hardware Configuration** screen, select **Use Following Configuration**. Click on the **Next** button to continue.

18. An **Installation Completed** screen appears, as show in Figure 2-8 on page 42. Click on the **Finish** button.

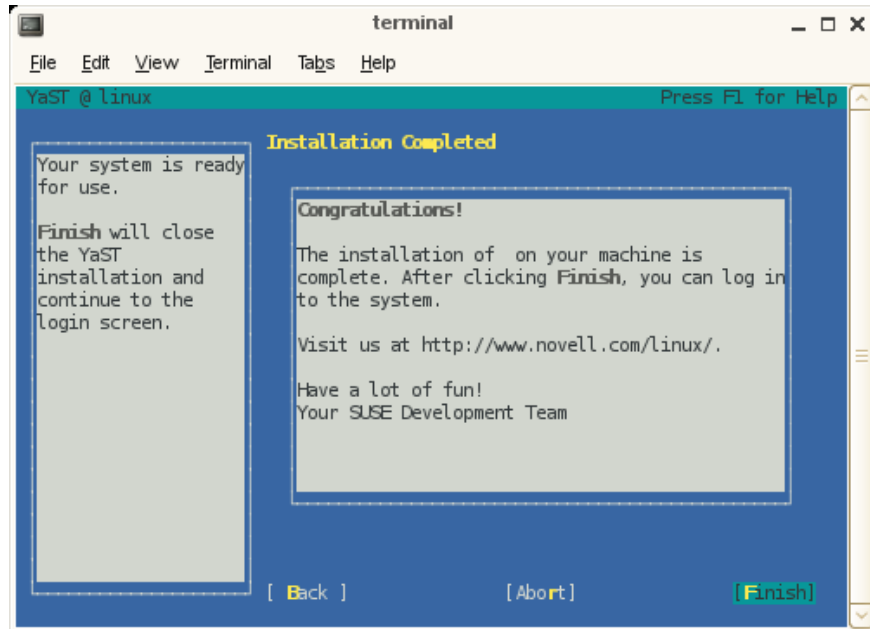

Figure 2-8 Installation Completed Screen

19. After you have completed the YaST first boot installation instructions, login into the system admin controller. You can use YaST to confirm or correct any configuration settings.

Note: It is important that you make sure that you network settings are correct before proceeding with cluster configuration.

20. You are now ready to run the `configure-cluster` command, proceed to the next section "configure-cluster Command Cluster Configuration Tool" on page 47.

Installing RHEL on the Admin Node

For RHEL service and admin nodes, you are strongly encouraged to **NOT** use `dhcp` for configuring the house network. That is because doing this can clobber the `/etc/resolv.conf` file temporarily. The SGI cluster management tools recreate this, but even if `resolv.conf` has house network settings for a short time, it could disrupt `nscd` caches and result in DNS lookup query failures that are not obvious to track down. If the you must use `dhcp` for the house network, add the `RESOLV_MODS=no` flag to the respective `/etc/sysconfig/ifcfg-ethX` file to prevent `resolv.conf` from being disrupted. SGI has found that certain RHEL operations can strip this line out, however.

Use text first boot or graphical first boot to install RHEL and then follow the Procedure 2-6, page 45 before you run the `configure-cluster` command.

Procedure 2-4 Installing RHEL on the Admin Node Using Text Firstboot

To install RHEL on the admin node perform the following steps:

1. Follow normal admin install DVD instructions.

When the system boots up, firstboot questions will start.

Note: The default root password is `sgisgi`.

If you want to use graphical firstboot, see Procedure 2-5, page 44.

2. Start it with the following command:

```
# /etc/init.d/firstboot start
```

3. To force it to run, use the following commands:

```
# touch /etc/reconfigSys
# /etc/init.d/firstboot
```

4. Use **Network configuration** to configure `eth0` for your house network.
5. Set **Firewall configuration**, appropriately.
6. Set up the time zone in **Timezone configuration**.
7. Currently, the following steps need to be performed before you start the `configure-cluster` command (see "configure-cluster Command Cluster Configuration Tool" on page 47).

- a. Update the root password.
- b. Configure your host name in `/etc/sysconfig/network` file with a line similar to the following:

```
HOSTNAME=system-admin
```

Note: Use the short name of the hostname with no dots.

- c. Configure name servers in the `/etc/resolv.conf` file.
- d. You can set `ONBOOT=no` in `/etc/sysconfig/network-scripts/ifcfg-eth1` file. This avoids a multi-minute timeout in the next step.
- e. Perform the following commands:

```
# /etc/init.d/network restart
# /etc/init.d/portmap start
```

Note: You can start the graphical `system-config-network` tool to configure these in a GUI. If you are on a remote system, make sure to use `ssh` with X11 forwarding (`-X`) or other method to display graphics from the admin node to your own workstation.

Procedure 2-5 Installing RHEL on the Admin Node Using Graphical Firstboot

To install RHEL on the admin node perform the following steps:

1. If text based firstboot is already running, choose **exit**.
2. If needed, perform the following command:

```
# touch /etc/reconfigSys
```
3. If you are connecting from a workstation, you need networking configured on the admin node at least enough to be able to `ssh` to the node. To do this, run `system-config-network` from the console and configure `eth0` with the proper networking values for your network.

4. After `system-config-network` exits, run the following commands:

```
# /etc/init.d/network restart
# /etc/init.d/portmap start
```

5. Use the following command, to connect to the admin node:

```
# ssh -X11 root@admin-node
```

6. Perform the following command:

```
# /etc/init.d/firstboot start
```

Currently, the following steps need to be performed before you start the `configure-cluster` command (see "configure-cluster Command Cluster Configuration Tool" on page 47).

- a. Configure `eth0` for your house network.
- b. Set up the host name and name servers
- c. Set up your timezone correctly. You do not need to set up your NTP servers yet. This is done in a later step. Any NTP server configuration done now would be lost later.
- d. Do not configure or register for updates in **Set Up Software Updates (RHN)**. Doing so will make creating `systemimager` images take too long. These updates need to be mirrored on the admin node in a later process.

Procedure 2-6 Repair `/etc/hosts` File

You must fix up the `/etc/hosts` file. In default installations, after configuring the IP addresses, one or both `localhost` entries may disappear from the `/etc/hosts` file. In addition, there must be a `hosts` entry for the house network interface of the admin node or `configure-cluster` will fail. The suggested method for fixing the `hosts` table is to use the `system-config-network` command in graphical mode, as follows:

1. Use the `cat` command to view the contents of the file and perform the following:
 - If there is **no** entry for `127.0.0.1` in the `hosts` table, take note of this.
 - If there is **no** `ipv6` entry for `:::1` in the `hosts` table, take note of this.
 - If there is **no** entry for your house network, take note of this.
2. Start `system-config-network` in graphical mode.

3. Click **New**.
4. A window comes up prompting for **Address**:, **Hostname**:, and **Aliases**.
5. For entries missing from the hosts table that you noted above, perform the following:
 - To add 127.0.0.1: enter `127.0.0.1` for **Address**, `localhost.localdomain` for **Hostname**, and `localhost` for **Aliases**.
 - To add `::1`: enter `::1` for **Address**, `localhost6.localdomain6` for **Hostname**, and `localhost6` for **Aliases**.
 - To add your house network, enter your admin node house IP for **Address**, the fully qualified hostname with dots for **Hostname**, and the hostname without dots for **Aliases**.

Note: The `system-config-network` command will **NOT** display the localhost entries in the GUI but it **will** add them. The entry for your house network will show up in the GUI.

6. Choose **File** -> **Save**.
7. If your hostname were 'foo' and your fully qualified domain name were 'foo.bar.org', then your `/etc/hosts` would look something like this after the steps above are complete:

```
::1      localhost6.localdomain6      localhost6
127.0.0.1    localhost.localdomain      localhost
128.162.244.88  foo.bar.org      foo
```

Note: If localhost is missing from `/etc/hosts`, various commands will fail to start up properly. If your hostname is missing from `/etc/hosts`, `configure-cluster` will error out.

8. At this point, enter `hostname -d` to confirm it returns the domain name. If it does not, try `nscd -i hosts` to invalidate the `nscd` hosts cache and see if `hostname` returns what you expect then. If not, reboot the admin node.
9. Set the root password with the `passwd` command.
10. You may now start the `configure-cluster` command.

`configure-cluster` Command Cluster Configuration Tool

The `configure-cluster` command launches a cluster configuration tool. It allows you to perform the following:

- Creates the root images for the service nodes, leader nodes, and compute blades
- Prompts for installation media including SLES10 SP2 and optionally SGI ProPack 6 SP1. The media is used to construct repositories that are used for software installation and updates.
- Runs a set of commands that allows you to setup the cluster
- Change the subnet numbers for the various cluster networks
- Configure the subdomain of the cluster (which is likely different than the domain of `eth0` on the system admin controller itself)
- Configure the InfiniBand network (see "InfiniBand Configuration" on page 77)

Information on using this tool is described in the procedure in the following section, see "Installing Software on the System Admin Controller" on page 31.

This section describes how to use `configure-cluster` command to configure the system administrator controller (admin node) for your Altix ICE system.

Procedure 2-7 Using the Cluster Configuration Tool to Configure Your System Admin Controller

To use the `configure-cluster` command to configure system admin controller (amin node), perform the following steps:

1. To start cluster configuration, enter the following command:

```
% /opt/sgi/sbin/configure-cluster
```

2. The **Cluster Configuration Tool: Initial Configuration Check** screen appears, as shown in Figure 2-9 on page 48. This tool provides instructions on the steps you need to take to configure your cluster. Click **OK** to continue.

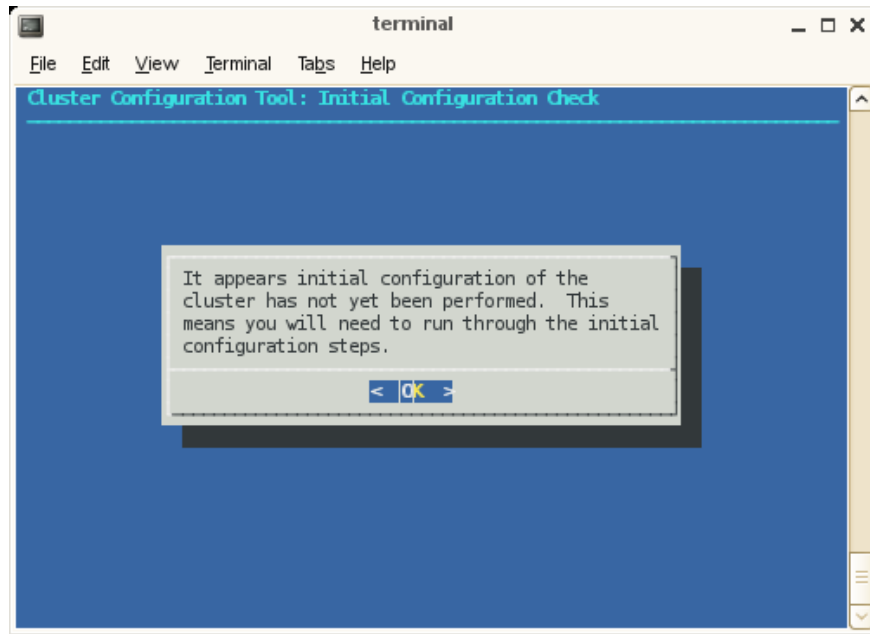

Figure 2-9 Cluster Configuration Tool: Initial Configuration Check Screen

3. The **Cluster Configuration Tool: Initial Cluster Setup** screen appears, as shown in Figure 2-10 on page 49. Read the notice and then click **OK** to continue.

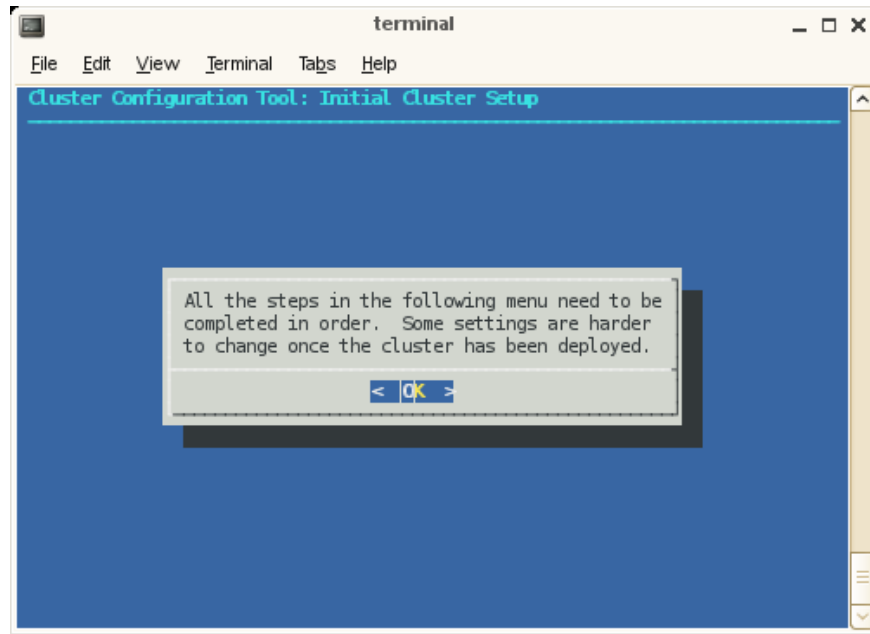

Figure 2-10 Cluster Configuration Tool: Initial Cluster Setup Screen

Note: The **Cluster Configuration Tool** has a main menu with sub-menus. You will be redirected back to the main menu, at various times, as you follow the steps in this procedure.

4. From the **Initial Cluster Setup** screen, select **Repo Manager: Set up Software Repos** and click **OK**.

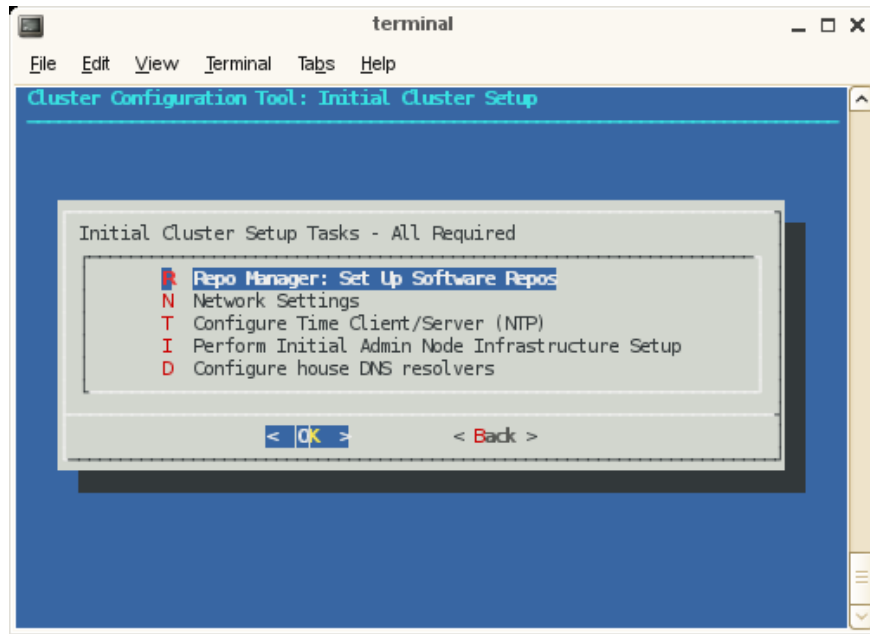

Figure 2-11 Initial Cluster Setup Tasks Screen

5.

Note: The next four screens use the `crepo` command to set up software repositories such as, SGI Foundation, SGI Tempo, SGI ProPack, and SLES10 SP2. For more information, see "crepo Command" on page 129.

To register ISO images from the admin node with Tempo and make them available to your cluster, click the **Yes** button.

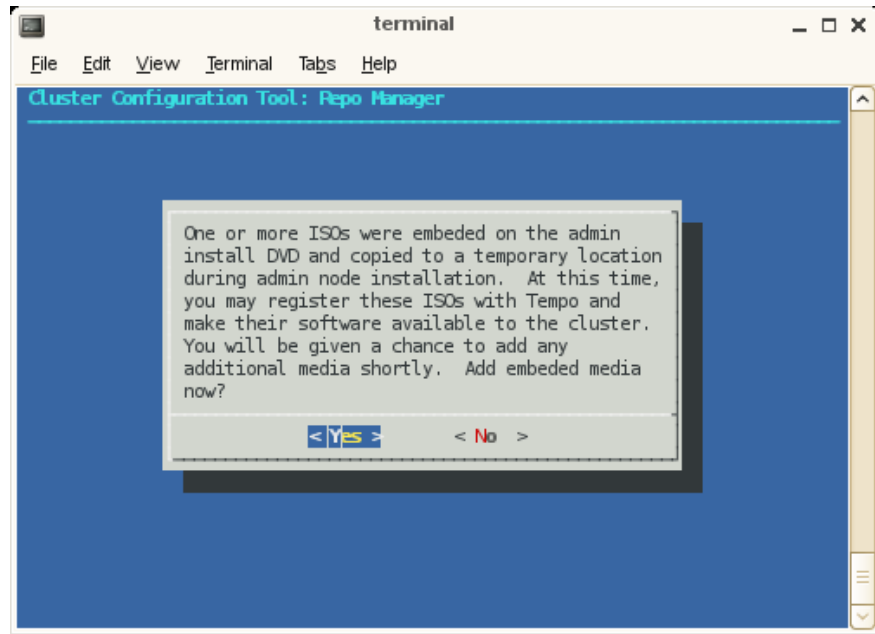

Figure 2-12 Cluster Configuration Tool: Repo Manager Screen One

6. To add the SLES media and other media, such as, SGI ProPack, click **OK**.

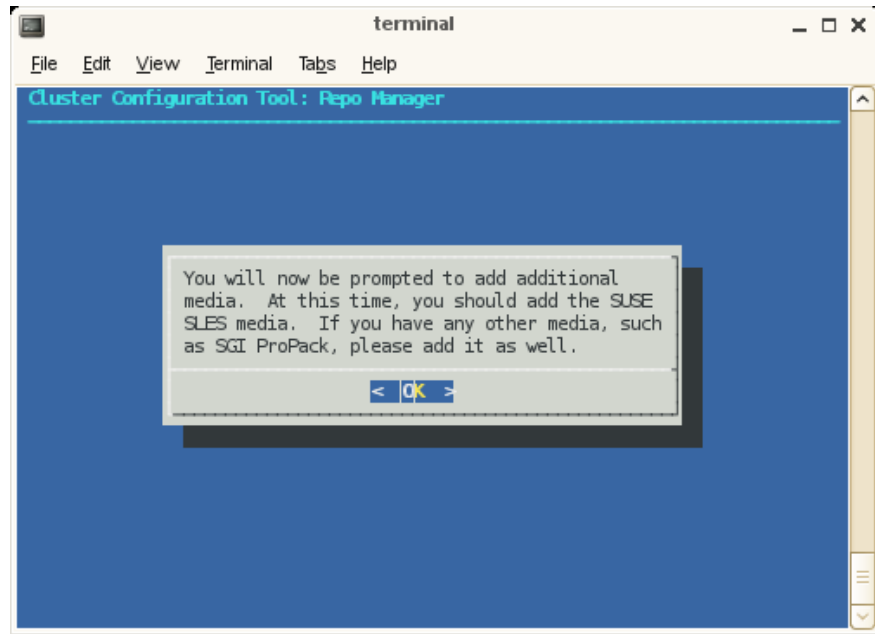

Figure 2-13 Cluster Configuration Tool: Repo Manager Screen Two

7. To register additional media with SGI Tempo, click **Yes**.

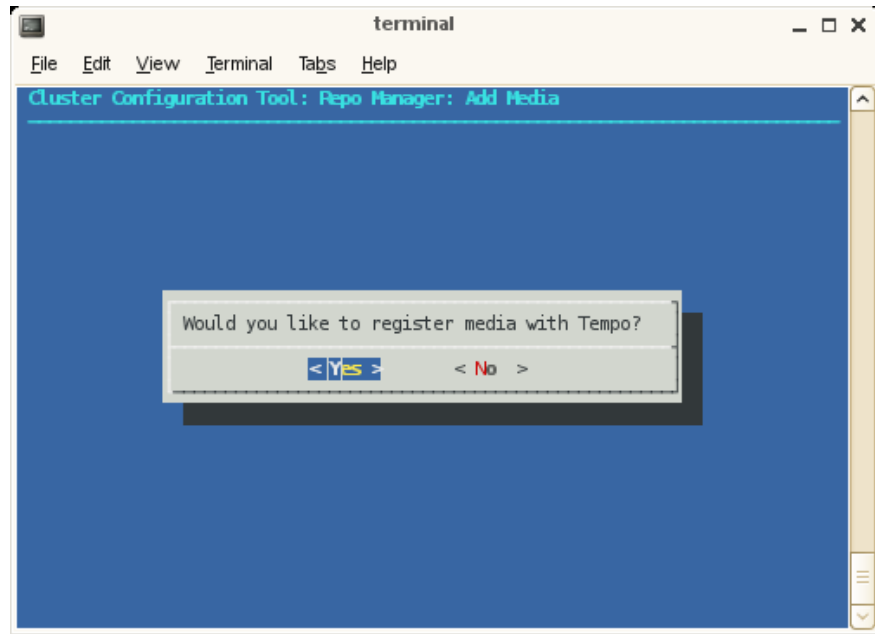

Figure 2-14 Cluster Configuration Tool: Repo Manager Screen Three

8. Enter the full path to the mount point or the ISO file or a URL or NFS path that points to an ISO file. Click **OK** to continue.

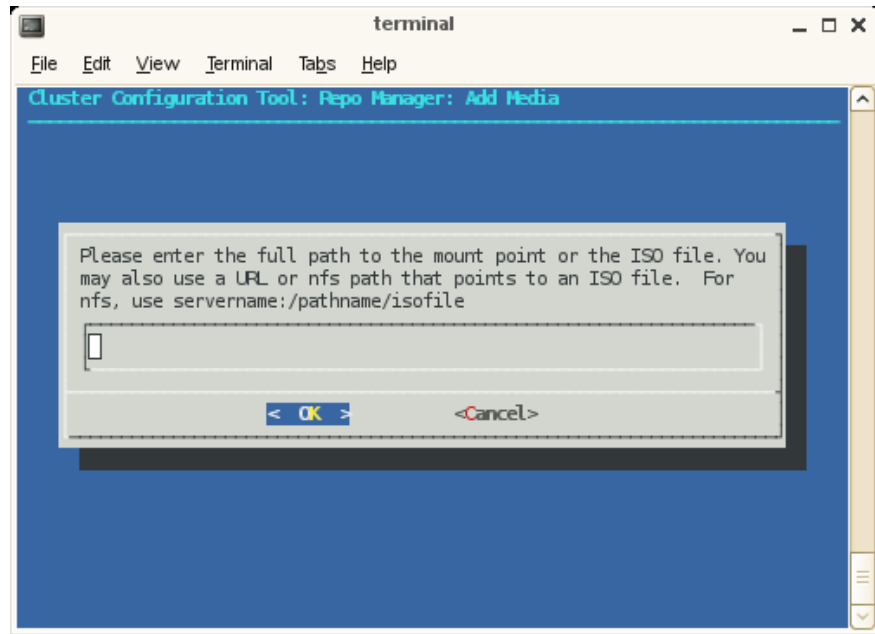

Figure 2-15 Cluster Configuration Tool: Repo Manager Screen Four

9. From the **Repo Manager: Add Media** screen, click **OK** to continue and eject your DVD if you used physical media.

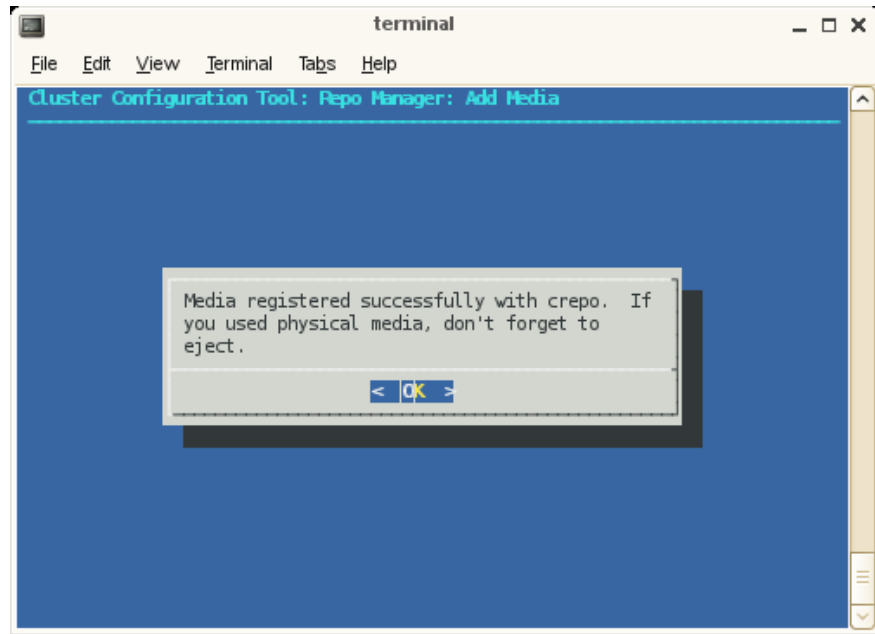

Figure 2-16 Cluster Configuration Tool: Repo Manager: Add Media Screen Four

Note: You will continue to be prompted to add additional media until you answer no. Once you answer no, you are directed back to the **Initial Cluster Setup Tasks** menu.

10. After choosing the **Network Settings** option, the **Cluster Network Setup** screen appears, as shown in Figure 2-17 on page 56.

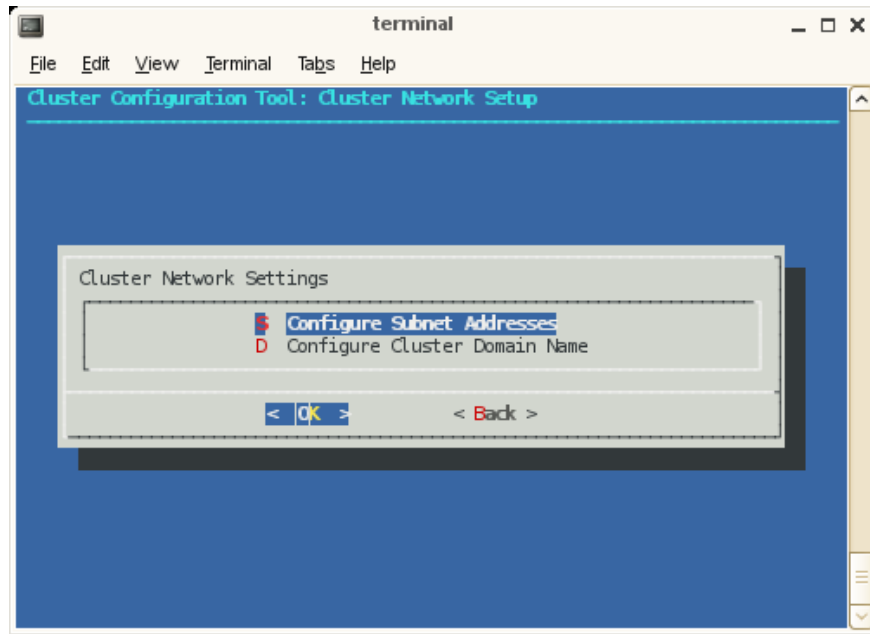

Figure 2-17 Cluster Network Setup Screen

The subnet addresses allows you to change the cluster internal network addresses. SGI recommends that you do NOT change these. Click **OK** to continue to adjust subnets. Otherwise, select **Domain Name: Configure Cluster Domain Name** and then skip to step 31. A warning screen appears, as shown in Figure 2-18 on page 57.

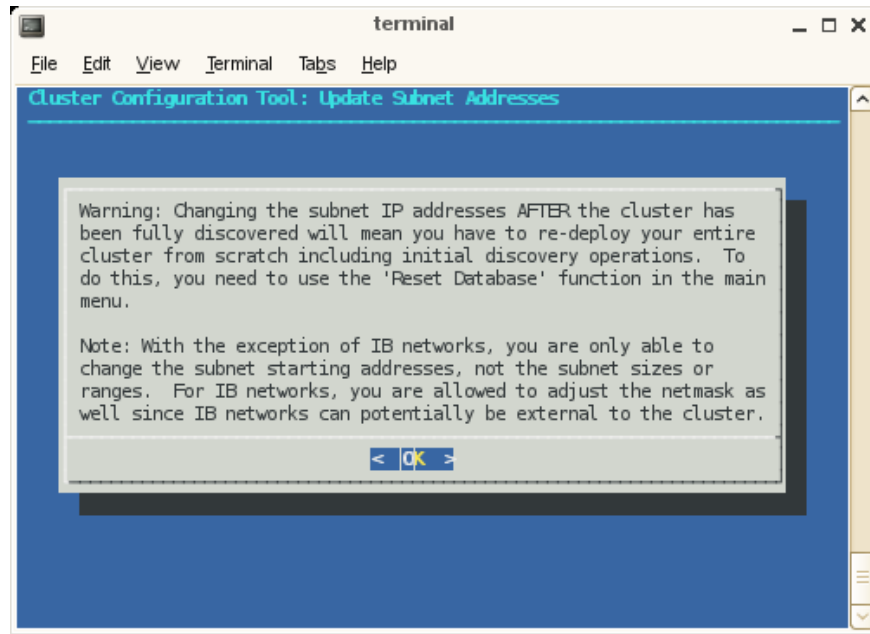

Figure 2-18 Update Subnet Address Warning Screen

Once you deploy your Altix ICE system, to change the network IP values or change domain names, you must reset the system data base and then rediscover the system. You do not need to reinstall the admin node, however. Click **OK** to continue.

11. The **Update Subnet Addresses** screen appears, as shown in Figure 2-19 on page 58.

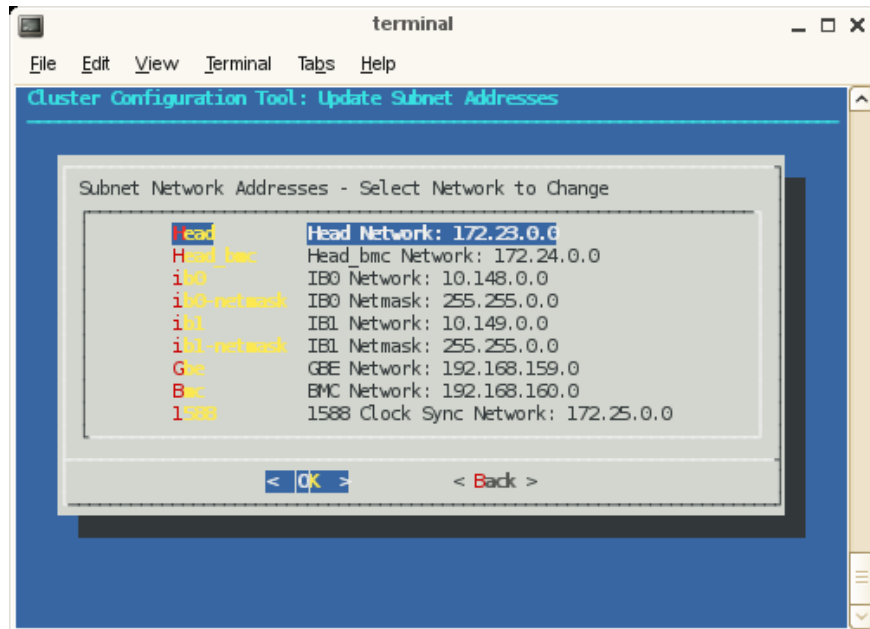

Figure 2-19 Update Subnet Addresses Screen

The default IP address of the system admin controller which is the **Head Network** for the Altix ICE system is shown. SGI recommends that you do NOT change the IP address of the system admin controller (admin node) or rack leader controllers (leader nodes) if at all possible. You can adjust the IP addresses of the InfiniBand network (**ib0** and **ib1**) to match the IP requirements of the house network. Click **OK** to continue.

12. Enter the domain name for your Altix ICE system, as shown in Figure 2-20 on page 59. Click **OK** to continue (this will be a subdomain to your house network, by default).

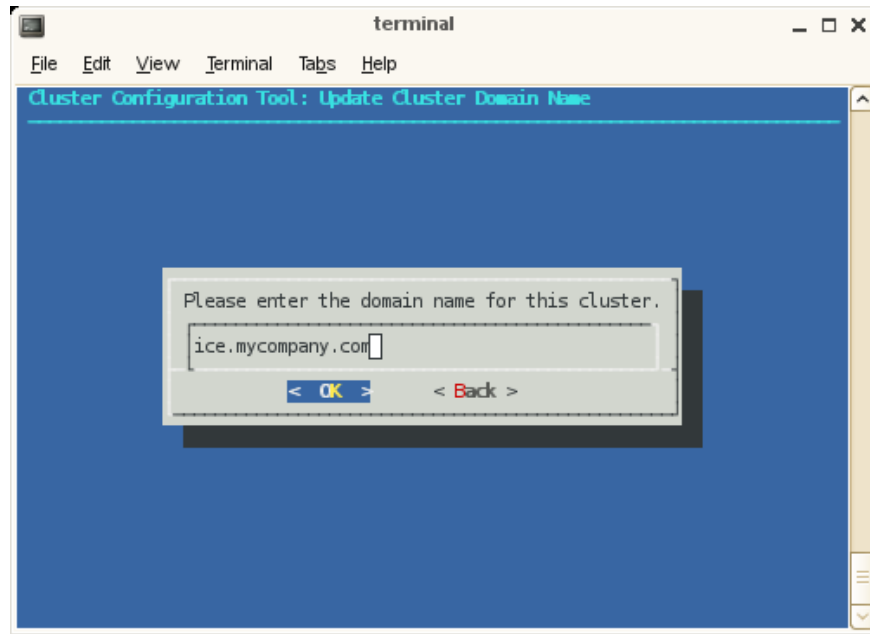

Figure 2-20 Update Cluster Domain Name Screen

13. The next operation in the **Initial Cluster Setup** menu is **NTP Time Server/Client Setup**. This procedure changes your NTP configuration file. Click on **OK** to continue. This sets the system admin controller to serve time to the Altix ICE system and allows you to add time servers on your house networks, which you may optionally use.

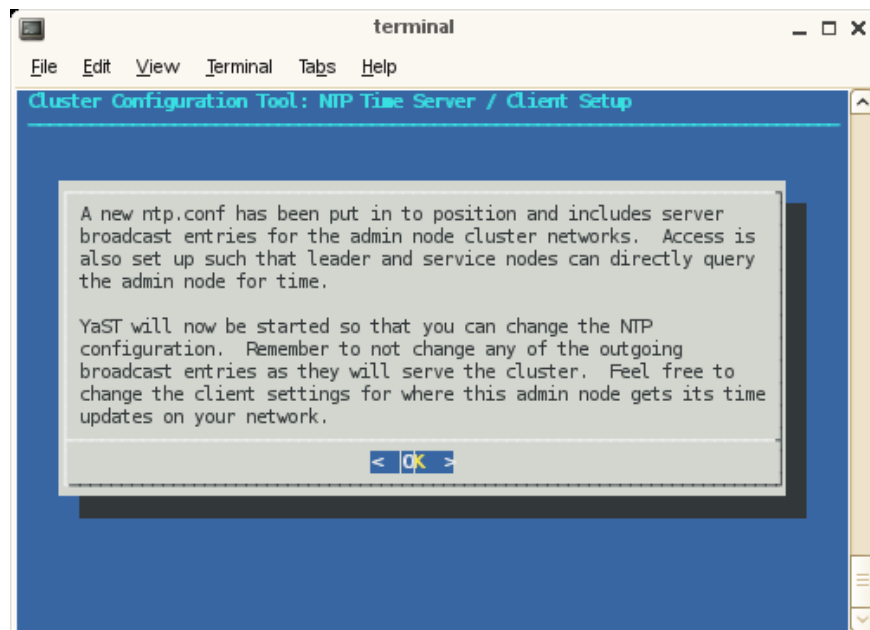

Figure 2-21 NTP Time Server/Client Setup Screen

14. Configure NTP time service as shown in Figure 2-22 on page 61. Click **Next** to continue.

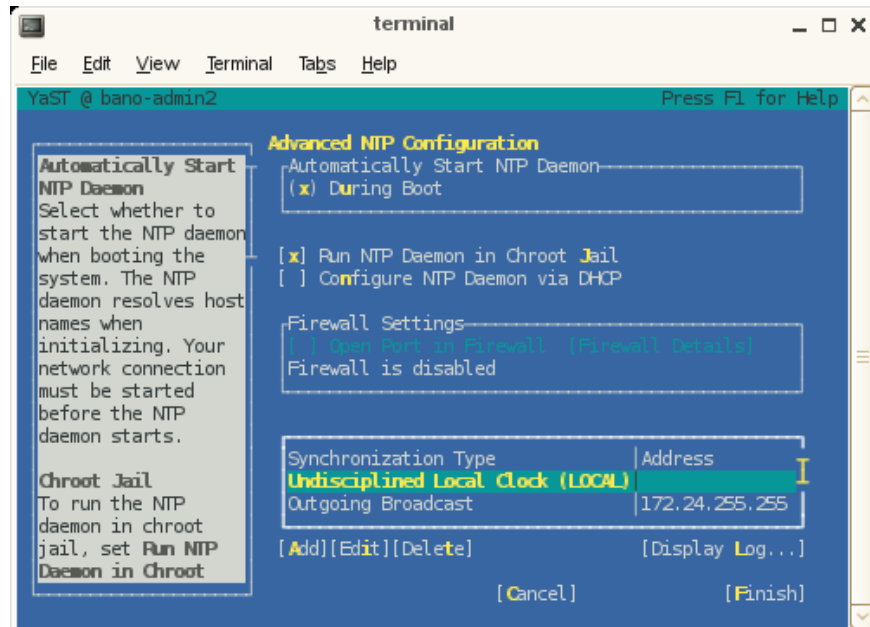

Figure 2-22 Advance NTP Configuration Screen

15. From the **New Synchronization** screen, select a synchronization peer and click **Next** to continue.

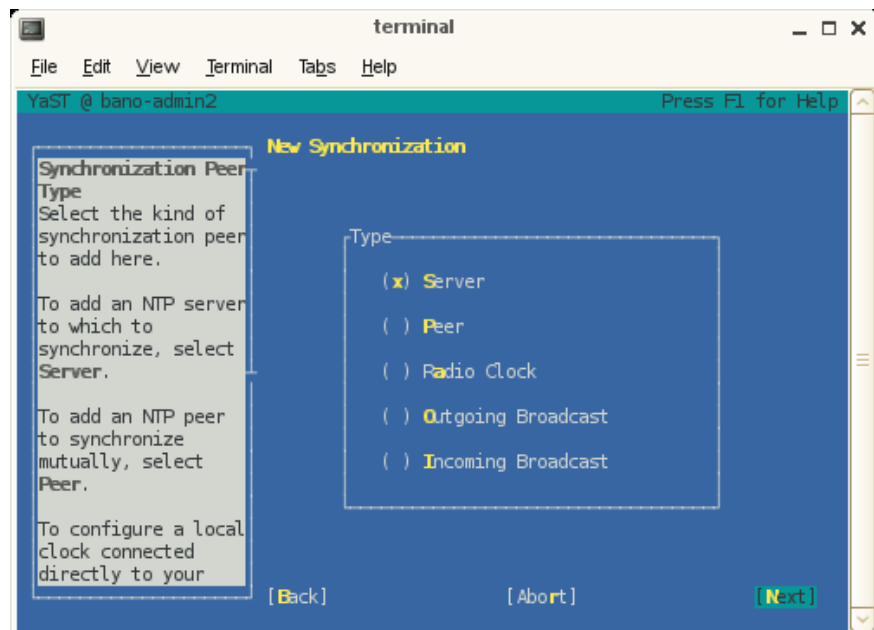

Figure 2-23 New Synchronization Screen

16. From the NTP Server screen, set the address of the NTP server and click OK to continue.

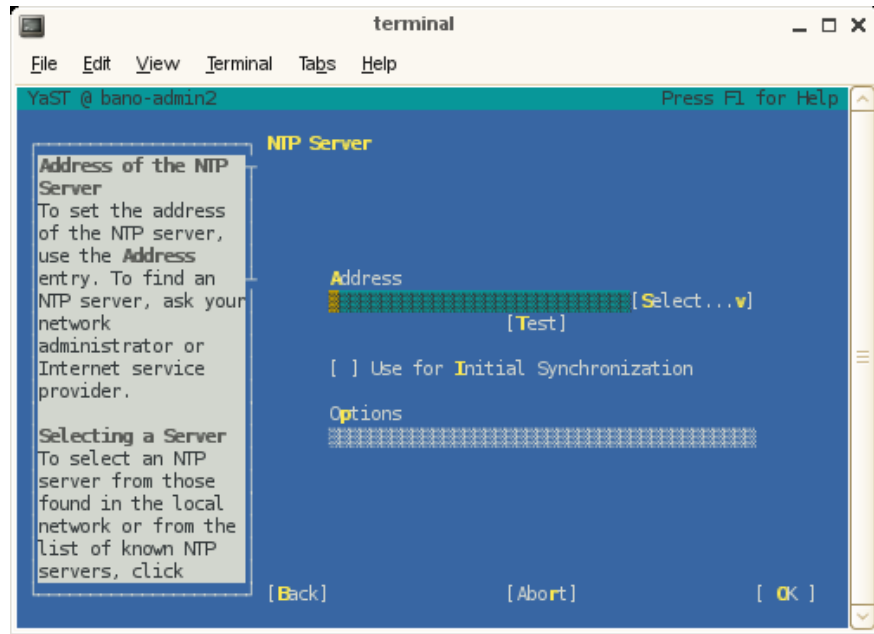

Figure 2-24 NTP Server Screen

17. The YaST tool completes. Click **OK** to continue.

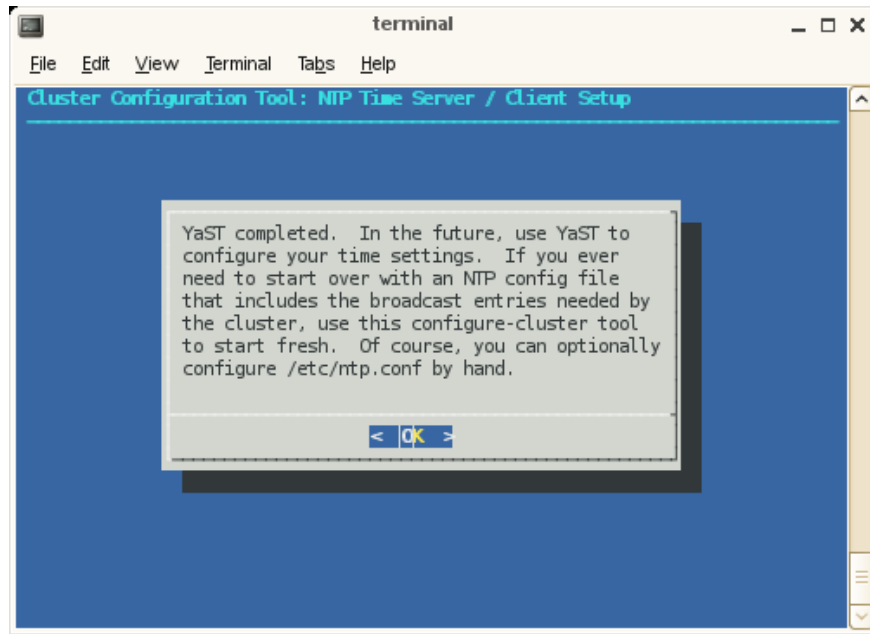

Figure 2-25 NTP Time Server/ Client Setup Screen Three

18. The next step in the **Initial Cluster Setup** menu directs you to select **Perform Initial Admin Node Infrastructure Setup**. This step runs a series of scripts that will configure the system admin controller of the Altix ICE system.

The script installs and configures your system and you should see an **install-cluster completed** line in the output.

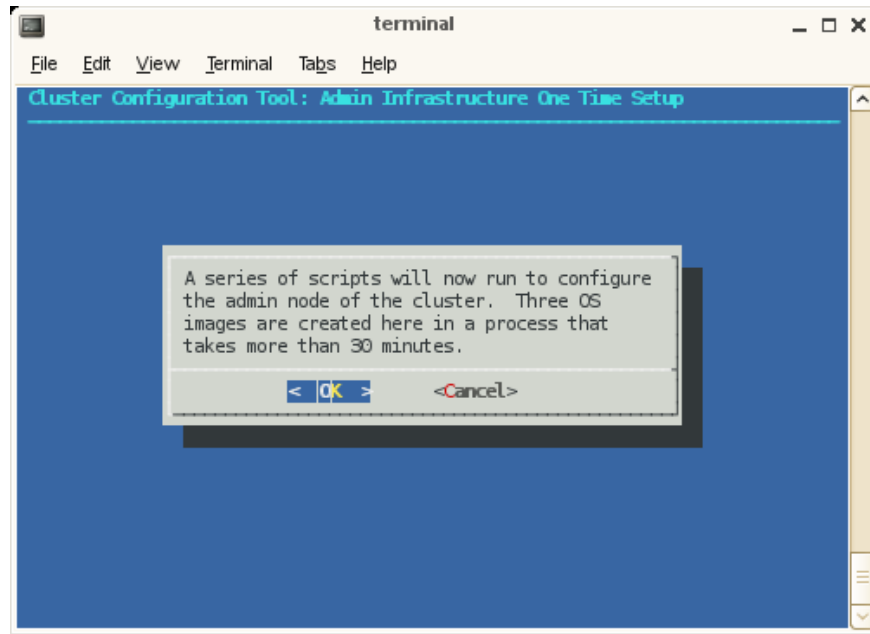

Figure 2-26 Admin Infrastructure One Time Setup Screen One

The root images for the service, rack leader controller, and compute nodes are then created. The output of the `mkssiimage` commands are stored in a location similar to the following:

```
/tmp/mkssiimage-cmds-out.12285
```

You can review the output if you so choose.

The final output of the script reads, as follows:

```
/opt/sgi/sbin/create-default-sgi-images Done!
```

Note: As it notes on the **Admin Infrastructure One Time Setup** screen, this step takes about 30 minutes.

Click **OK** to continue.

19. The next step in the **Initial Cluster Setup** menu is to configure the house DNS resolvers. It is OK to set these resolvers to the same name servers used on the system admin controller itself. Configuring these servers is what allows service nodes to resolve host names on your network. For a description of how to set up service nodes, see "Service Node Discovery, Installation and Configuration" on page 77. This menu has default values printed that match your current admin node resolver setup. If this is ok, just select **OK** to continue. Otherwise, make any changes you wish to the resolver listing and select **OK**. If you do not wish to have any house resolvers, select **Disable House DNS**.

After entering the IPs, click **OK** to enable, click **Disable House DNS** to stop using house DNS resolution, click **Back** to leave house DNS resolution as it was when you started (disabled at installation).

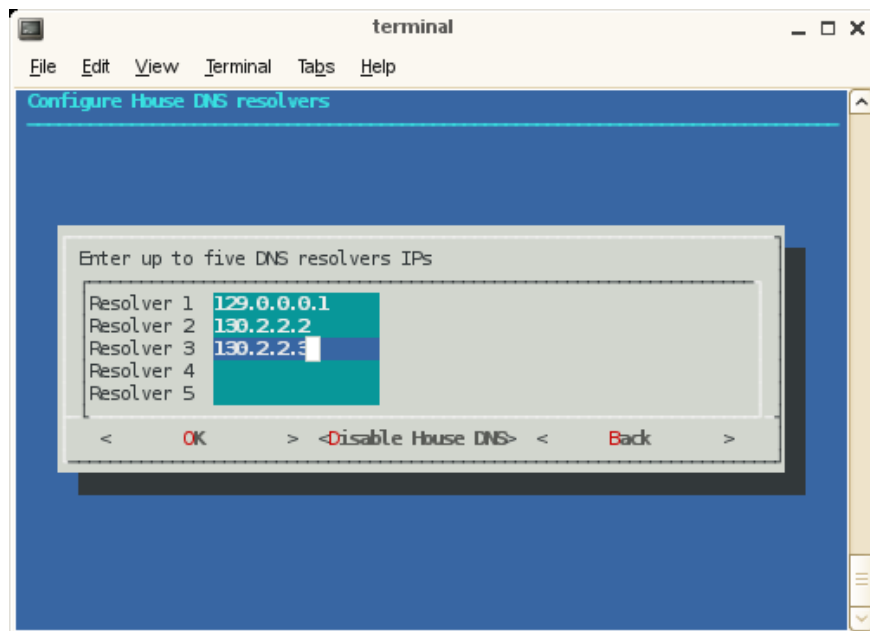

Figure 2-27 Configure House DNS Resolvers Screen

20. The setting DNS forwarding screen appears. Click **Yes** to continue.

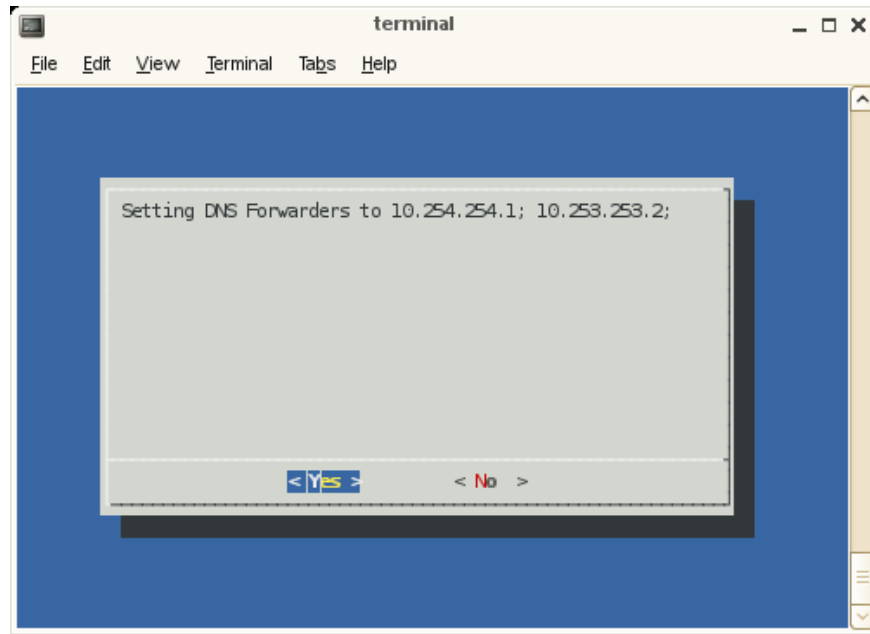

Figure 2-28 Setting DNS Forwarding Screen

21. The **Initial Cluster Setup complete message** appears. Click OK to continue.

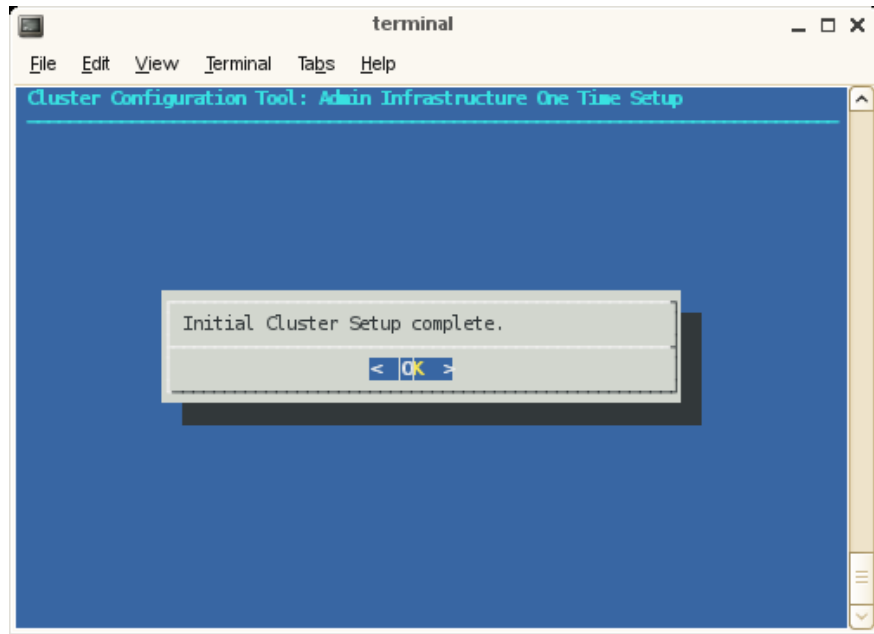

Figure 2-29 Cluster Configuration Tool: Admin Infrastructure One Time Setup Screen

22. Proceed to "Installing Software on the Rack Leader Controllers and Service Nodes" on page 72. It describes the discovery process for the rack leader controllers in your system and how to install software on the rack leader controllers.

Note: The main menu contains a **reset** the database function that allows you to start software installation over without having to reinstall the system admin controller.

discover Command

The `discover` command is used to discover rack leader controllers (leader nodes), service nodes, including their associated BMC controllers, in an entire system or in a set of one or more racks that you select. Rack numbers generally start at one. Service nodes generally start at zero. When you use the `discover` command to perform the discovery operation on your Altix ICE system, you will be prompted with

instructions on how to proceed (see "Installing Software on the Rack Leader Controllers and Service Nodes" on page 72).

Note: For the Tempo 1.5 release (or later), the operation of the `discover` command `--delrack` and `--delservice` options has changed. Now when using these options, the node is not removed completely from the database but it is marked with the administrative status `NOT_EXIST`. When you go to discover a node that previously existed, you now get the same IP allocations you had previously and the node is then marked with the administrative status of `EXIST`. If you have a service node, for example, `service0`, that has a custom host name of "myhost" and you later go to delete `service0` using the `discover --delservice` command, the host name associated with it will still be present. This can cause conflicts if you wish to reuse the custom host name "myhost" on a node other than `service0` in the future. You can use the `cadmin --db-purge --node service0` command that will remove the node entirely from the database (for more information, see "cadmin: SGI Tempo Administrative Interface" on page 165). You can then reuse the "myhost" name.

For a `discover` command usage statement, perform the following:

```
sys-admin ~# discover --h
```

Discover allows any number of racks, service nodes, or external switches to be discovered in one command line.

```
/opt/sgi/sbin/discover --rack <#>[,<options>]  
/opt/sgi/sbin/discover --rackset <start-number>,<count>[,<options>]  
/opt/sgi/sbin/discover --service <#>[,<options>]  
/opt/sgi/sbin/discover --switch <name>[,<options>]
```

```
--rack: discover a specific rack or set of racks (more than one --rack ok)  
--rackset: discover count racks starting at start-number  
--service: discover the specified service node  
--switch: discover the specified external switch  
--delrack: Mark rack leaders as deleted  
--delservice: Mark a service node as deleted  
--delswitch: Mark an external switch as deleted  
--force: Not normally used. Avoid sanity checks that require input.  
--ignoremac <mac>: Not normally used. See description below.  
--macfile <file>: Not normally used. See description below.
```

This script is used to discover lead nodes and service nodes in an entire system or in a set of one or more racks that you select.

Rack numbers generally start at one. Service nodes generally start at zero. Switches are specified by name.

<options> is a list of comma separated options that modify how discover proceeds for the associated node and sets it up for installation. Hardware types (see below) have no variable style naming with equal signs. All other option types take the form "name=value".

Options include:

hardware type: A hardware model that affects how discover proceeds. The list of options are at the end of this help message. If a hardware type isn't specified, a default value is used. Use the 'other' hardware type for a service node you supply and manage. This mode will allocate IPs for you and print them to the screen. It won't be managed by the cluster management software. See the examples section for how to use the hardware type.

image type: You can specify an alternate image to install on to the target system. See the examples for how to specify this. Alternate image names can be supplied for managed service nodes and leaders.

net: ib0 or ib1 for external IB switches only.

If you wish to re-discover an existing service node or rack, simply run the discover command in the same manner you would normally. If you wish to purge a rack or service node entirely -- never to be seen again -- use --delservice / --delrack for this. The same applies to external switches.

Expanded descriptions for other arguments:

--macfile:

Instead of discovering MACs by power cycling when instructed, consult the file for the MAC instead. This is not normally used. All MACs to be discovered must be in the file. File format:

<hostname> <bmc-mac> <host-mac>

Example file contents:

```
rllead 00:11:22:33:44:55 66:77:88:99:EE:FF
service0 00:00:00:00:00:0A 00:00:00:00:00:0B
```

--ignoremac:

A MAC address to ignore during discover operations. Not normally needed. Multiple `--ignoremac` options may be specified.

Instructions on how to proceed with discover will be provided when you perform a discover.

EXAMPLES

Example 2-1 discover Command Examples

The following examples walk you through some typical discover command operations.

To discover rack 1 and service node 0, perform the following:

```
# /opt/sgi/sbin/discover --rack 1 --service 0,xe210
```

In this example, service node 0 is an Altix XE210 system.

To discover racks 1-5, and service node 0-2, perform the following:

```
# /opt/sgi/sbin/discover --rackset 1,5 --service 0,xe240 --service 1,altix450 --service 2,other
```

In this example, service node 1 is an Altix 450 system. Service node 2 is *other* hardware type.

To discover service 0, but use `service-myimage` instead of `service-sles10sp2` (default), perform the following:

```
# /opt/sgi/sbin/discover --service 0,image=service-myimage
```

Note: You may direct a service node to image itself with a custom image later, without re-discovering it. See "cinstallman Command" on page 131.

To discover racks 1 and 4, service node 1, and ignore MAC address `00:04:23:d6:03:1c`, perform the following:

```
# /opt/sgi/sbin/discover --ignoremac 00:04:23:d6:03:1c --rack 1 --rack 4 --service 0
```

The Tempo v1.6 release (and later), the `discover` command supports external switches in a manner similar to racks and service nodes, except that switches do not

have BMCs and there is no software to install. The syntax to add a switch is, as follows:

```
discover --switch name, hardware, net=fabric
```

where *name* can be any alphanumeric string, *hardware* is any one of the supported switch types (run `discover --help` to get a list), and *fabric* is either `ib0` or `ib1`.

An example command is, as follows:

```
# discover --switch extsw,voltaire-isr-9024,net=ib0
```

Once `discover` has assigned an IP address to the switch, it will call the fabric management `sgifmcli` command to initialize it with the information provided. The `/etc/hosts` and `/etc/dhcpd.conf` files should also have entries for the switch as named, above. You can use the `cnodes --switch` command to list all such nodes in the cluster.

To remove a switch, perform the following:

```
discover --delswitch name
```

where *name* is that of a previously discovered switch.

An example command is, as follows:

```
# discover --delswitch extsw
```

Installing Software on the Rack Leader Controllers and Service Nodes

The `discover` command, described in "discover Command" on page 68, sets up the leader and managed service nodes for installation and discovery. This section describes the discovery process you use to determine the Media Access Control (MAC) address, that is, the unique hardware address, of each rack leader controller (leader nodes) and then how to install software on the rack leader controllers.

Procedure 2-8 Installing Software on the Rack Leader Controllers and Service Nodes

To install software on the rack leader controllers, perform the following steps:

1. Use the `discover` command from the command line, as follows:

```
# /opt/sgi/sbin/discover --rack 1
```

Note: You can discover multiple racks at a time using the `--rackset` option. Service nodes can be discovered with the `--service` option.

The `discover` script executes. When prompted, turn the power on to the node being discovered and only that node.

Note: Make sure you only power on the node being discovered and nothing else in the system. Make sure not to power the system up itself.

When the node has electrical power, the BMC starts up even though the system is not powered on. The BMC does a network DHCP request that the `discover` script intercepts and then configures the cluster database and DHCP with the MAC address for the BMC. The BMC then retrieves its IP address. Next, this script instructs the BMC to power up the node. The node performs a DHCP request that the script intercepts and then configures the cluster database and DHCP with the MAC address for the node. The rack leader controller installs itself using the `systemimager` software and then boots itself.

The `discover` script will turn on the chassis identify light for 2 minutes. Output similar to the following appears on the console:

```
Discover of rack1 / leader node r1lead complete
r1lead has been set up to install itself using systemimager
The chassis identify light has been turned on for 2 minutes
```

2. The blue chassis identify light is your cue to power on the next rack leader controller and start the process all over.

You may watch install progress by using the `console` command. For example, `console r1lead` connects you to the console of the `r1lead` so that you can watch installation progress. The sessions are also logged. For more information on the `console` command, see "Console Management" on page 168.

3. Using the identify light, you can configure all the rack leader controllers and service nodes in the cluster without having to go back and forth to and from your workstation between each discovery operation. Just use the identify light on the node that was just discovered as your cue to move to the next node to plug in.
4. Shortly after the `discover` command reports that discovery is complete for a given node, that node installs itself. If you supplied multiple nodes on the

`discover` command line, it is possible multiple nodes could be in different stages of the imaging/installation process at the same time. For rack leaders, when the leader boots up for the first time, one process it starts is the `blademon` process. This process discovers the IRUs and attached blades and sets them up for use. The `blademon` process is described in "blademon Command For Automatic Blade Discovery" on page 75, including which files to watch for progress.

If your `discover` process does **not** find the appropriate BMC after a few minutes, the following message appears:

```
=====
Warning: Trouble discovering the BMC!
=====
3 minutes have passed and we still can't find the BMC we're looking for.
We're going to keep looking until/if you hit ctrl-c.
```

Here are some ideas for what might cause this:

- Ensure the system is really plugged in and is connected to the network.
- This can happen if you start `discover` AFTER plugging in the system. Discover works by watching for the DHCP request that the BMC on the system makes when power is applied. Only nodes that have already been discovered should be plugged in. You should only plug in service and leader nodes when instructed.
- Ensure the CMC is operational and passing network traffic.
- Ensure the CMC firmware up to date and that it's configured to do VLANs.
- Ensure the BMC is properly configured to use `dhcp` when plugged in to power.
- Ensure the BMC, `frusdr`, and bios firmware up to date on the node.
- Ensure the node is connected to the correct CMC port.

Still Waiting. Hit `ctrl-c` to abort this process. That will abort discovery at this problem point -- previously discovered components will not be affected.

```
=====
```

If your `discover` process finds the appropriate BMC, but cannot find the leader or service node that is powered up after a few minutes, the following message appears:

```
=====
Warning: Trouble discovering the NODE!
=====
4 minutes have passed and we still can't find the node.
```

We're going to keep looking until/if you hit ctrl-c.

If you got this far, it means we did detect the BMC earlier, but we never saw the node itself perform a DHCP request.

Here are some ideas for what might cause this:

- Ensure the BIOS boot order is configured to boot from the network first
- Ensure the BIOS / frusdr / bmc firmware are up to date.
- Is the node failing to power up properly? (possible hardware problem?) Consider manually pressing the front-panel power button on this node just in case the ipmitool command this script issued failed.
- Try connecting a vga screen/keyboard to the node to see where it's at.
- Is there a fault on the node? Record the error state of the 4 LEDs on the back and contact SGI support. Consider moving to the next rack in the mean time, skipping this rack (hit ctrl-c and re-run discover for the other racks and service nodes).

Still Waiting. Hit ctrl-c to abort this process. That will abort discovery at this problem point -- previously discovered components will not be affected.

=====

5. You are now ready to discover and install software on the compute blades in the rack. For instructions, see "Discovering Compute Nodes" on page 76.

blademon Command For Automatic Blade Discovery

You no longer need to explicitly call the `discover-rack` command to discover a rack and integrate new blades. This is done automatically by a the `blademon` daemon that runs on the leader nodes.

The `blademon` daemon is started up when the leader node boots after imaging and begins to poll the chassis management control (CMC) blade in each IRU to determine if any new blades are present. It polls the CMCs every two minutes to see if anything has changed. If something has changed (a new blade, a blade removed, or a blade swapped), it sends the new slot map to the admin node and calls the `discover-rack` command to integrate the changes. It then boots new nodes on the default compute image.

The `blademon` daemon maintains its log file at `/var/log/blademon` on the leader nodes.

You can turn on debug mode in the `blademon` daemon by sending it a `SIGUSR1` signal from the leader node, as follows:

```
# kill -USR1 pid
```

To turn debug mode off, send it another `SIGUSR1` signal. You should see a message in the `blademon` log about debug mode being enabled or disabled.

The `blademon` daemon maintains the slot map at

`/var/opt/sgi/lib/blademon/slot_map` on the leader nodes. This appears as `/var/opt/sgi/lib/blademon/slot_map.rack_number` on the admin node.

Discovering Compute Nodes

This section describes how to discover compute nodes in your Altix ICE system.

Note: You no longer need to explicitly call the `discover-rack` command to discover a rack and integrate new compute nodes (blades). This is done automatically by the `blademon` daemon that runs on the leader nodes (see "blademon Command For Automatic Blade Discovery" on page 75).

Procedure 2-9 Discovering Compute Nodes

To discover compute nodes (blades) in your Altix ICE system, perform the following:

1. Complete the steps in "Installing Software on the Rack Leader Controllers and Service Nodes" on page 72.
 2. For instructions on how to configure, start, verify, or stop the InfiniBand Fabric management software on your Altix ICE system, see Chapter 4, "System Fabric Management" on page 183.
-

Note: The InfiniBand fabric does not automatically configure itself. For information on how to configure and start up the InfiniBand fabric, see Chapter 4, "System Fabric Management" on page 183.

Service Node Discovery, Installation and Configuration

Service nodes are discovered and deployed similar to rack leader controllers (leader nodes). The `discover` command, with the `--service` related commands, allow you to discover service nodes in the same discover operation that discovered the leader nodes.

Like rack leader controllers, the service node is automatically installed. The `service-image` is used to install the service node.

Unlike system admin controllers (admin nodes), `eth0` on the service node connects to the Altix ICE network (like rack leader controllers). If you wish to have the service node on your house network, you need to configure the second Ethernet interface (`eth1`).

The `yast2-firstboot` software does not start automatically on the system console after the first boot after installation (unlike the admin node). Use YAST to set up the public/house network on the service node, as follows:

- `eth1` is the house network that you should configure in firstboot.
- If you change the default host name, you need to make sure that the cluster service name is still resolvable as tools depend on that.
- Name service configuration is handled by the admin and leader nodes. Therefore, service node `resolv.conf` files need to always point to the admin and leader nodes in order to resolve cluster names. If you wish to resolve host names on your "house" network, use the `configure-cluster` command to configure the house name servers. The admin and leader nodes will then be able to resolve your house network addresses, in addition to the internal cluster hostnames. Besides, the cluster configuration update framework may replace your `resolv.conf` file anyway when cluster configuration adjustments are made.

Do not change `resolv.conf` and do not configure different name servers in `yast`.

InfiniBand Configuration

Before you start configuring the InfiniBand network, you need to ensure that all hardware components of the cluster have been discovered successfully, that is, admin, leader, service and compute nodes. You also need to be finished with the cluster configuration steps in "configure-cluster Command Cluster Configuration Tool"

on page 47. To configure the InfiniBand network, start the `configure-cluster` command again on the admin node. Since the **Initial Setup** has been done already, you can now use the **Configure InfiniBand Fabric** option to configure the InfiniBand fabric as shown in Figure 2-30.

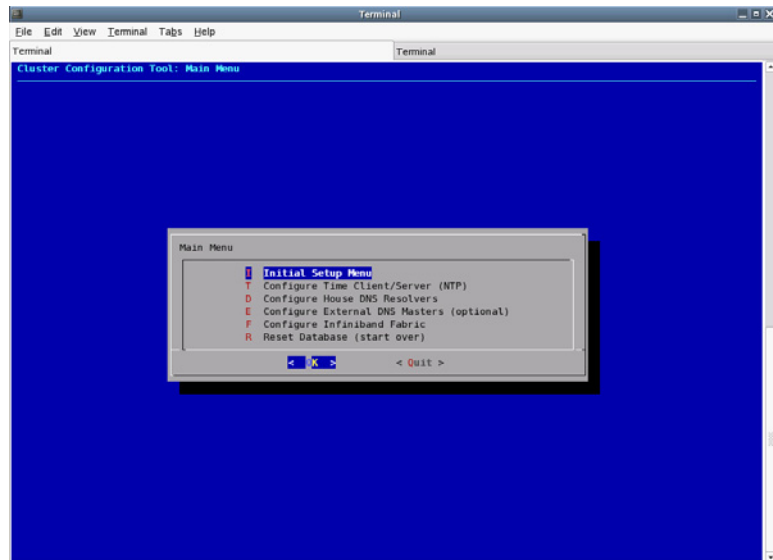

Figure 2-30 Configure InfiniBand Fabric from Cluster Configuration Tool

Select the **Configure InfiniBand Fabric** option, the InfiniBand Fabric Management tool appears, as shown in Figure 2-31.

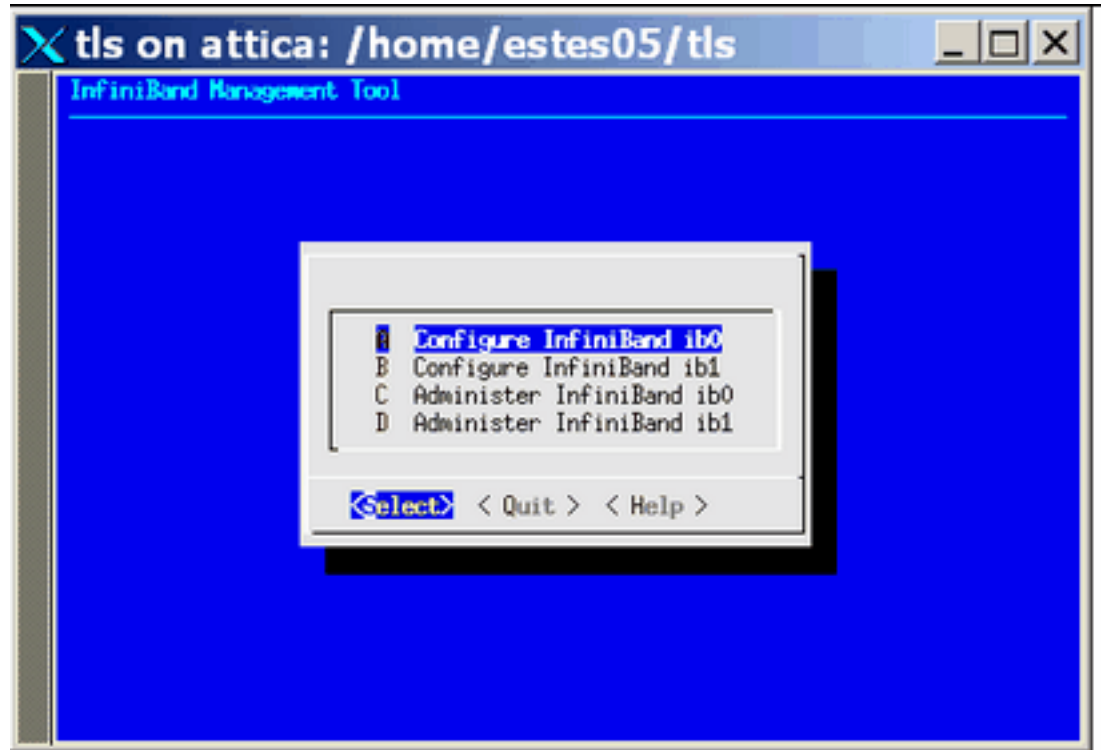

Figure 2-31 InfiniBand Management Tool Screen

Use the the online help available with this tool to guide you through the InfiniBand configuration. After configuring and bringing up the InfiniBand network, select the **Administer InfiniBand ib0** option or the **Administer InfiniBand ib1** option, the **Administer InfiniBand** screen appears as shown in Figure 2-32. Verify the status using the **Status** option.

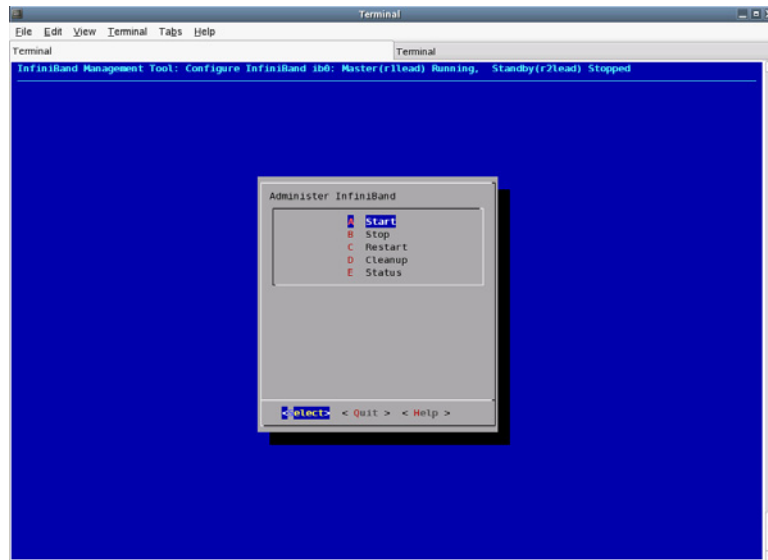

Figure 2-32 Administer InfiniBand GUI

Configuring the Service Node

This section describes how to configure a service node and covers the following topics:

- "Service Node Configuration for NAT" on page 80
- "Using External DNS for Compute Node Name Resolution " on page 83
- "Service Node Configuration for DNS" on page 84
- "Service Node Configuration for NFS " on page 84
- "Service Node Configuration for NIS for the House Network" on page 85

Service Node Configuration for NAT

You may want to reach network services outside of your SGI Altix ICE 8200 system. For this type of access, SGI recommends using Network Address Translation (NAT), also known as IP Masquerading or Network Masquerading. Depending on the

amount of network traffic and your site needs, you may want to have multiple service nodes providing NAT services.

Procedure 2-10 Service Node Configuration for NAT

To enable NAT on your service node, perform the following steps:

1. Use the configuration tools provided on your service node to turn on IP forwarding and enable NAT/IP MASQUERADE.

Specific instructions should be available in the third-party documentation provided for your storage node system. Additional documentation is available at `/opt/sgi/docs/setting-up-NAT/README`. This document describes how to get NAT working for both IB interfaces.

Note: This file is only on the service node. You need to `# ssh service0` and then from service 0 `# cd /opt/sgi/docs/setting-up-NAT`.

2. Update the all of the compute node images with default route configured for NAT.
SGI recommends a script on the system admin controller at `/opt/sgi/share/per_host_customization/global/sgi-static-routes` that can customize the routes based upon rack, IRU, and slot of the compute blade. Some examples are available in that script.
3. Use the `cimage --push-rack` command to propagate the changes to the proper location for compute nodes to boot. For more information on using the `cimage` command, see "cimage Command" on page 141 and "Customizing Software On Your SGI Altix ICE System" on page 134.
4. Use the `cimage --set` command to select the image.
5. Reboot/reset the compute nodes using that desired image.
6. Once the service node(s) has NAT enabled, is attached to an operational house network, and the compute nodes are booted from an image which sets their routing to point at the service node, test the NAT operation by using the `ping(8)` command to ping known IP addresses on the house network from an interactive session on the compute blade.
7. See the troubleshooting discussion that follows.

Troubleshooting Service Node Configuration for NAT

Troubleshooting can become very complex. The first steps are to determine that the service node(s) are correctly configured for the house network and can ping the house IP addresses. Good choices are house name servers possibly found in the `/etc/resolv.conf` or `/etc/name.d.conf` files on the admin node. Additionally, the default gateway addresses for the service node may be a good choice. You can use the `netstat -rn` command for this information, as follows:

```
system-1:/ # netstat -rn
Kernel IP routing table
Destination      Gateway          Genmask         Flags   MSS Window  irtt Iface
128.162.244.0    0.0.0.0         255.255.255.0  U       0  0        0 eth0
172.16.0.0       0.0.0.0         255.255.0.0    U       0  0        0 eth1
169.254.0.0     0.0.0.0         255.255.0.0    U       0  0        0 eth0
172.17.0.0      0.0.0.0         255.255.0.0    U       0  0        0 eth1
127.0.0.0       0.0.0.0         255.0.0.0      U       0  0        0 lo
0.0.0.0         128.162.244.1  0.0.0.0        UG      0  0        0 eth0
```

If the `ping` command executed from the service node to the selected IP address gets responses, network monitoring tools such as `tcpdump(1)` should be used. On the service node, monitor the `eth1` interface and simultaneously in a separate session monitor the `ib[01]` interface. You should specify monitoring specific-enough to not have additional noise then attempt execute a `ping` command from the compute node.

Example 2-2 `tcpdump` Command Examples

```
tcpdump -i eth1 ip proto ICMP # Dump ping packets on the public side of service node.
tcpdump -i ib1 ip proto ICMP # Dump ping packets on the IB fabric side of service node.
tcpdump -i eth1 port nfs # Dump NFS traffic on the eth1 side of service node.
tcpdump -i ib1 port nfs # Dump NFS traffic on the eth1 side of service node.
```

If packets do not reach the service nodes respective IB interface, perform the following:

- Check the system admin controller's compute image configuration of the default route.
- Verify that this image has been pushed to the compute nodes.
- Verify that the compute nodes have booted with this image.

If the packets reach the service nodes IB interface, but do not exit the `eth1` interface, verify the NAT configuration on the service node.

If the packets exit the `eth1` interface, but replies do not return, verify the house network configuration and that IP masquerading is properly configured so that the packets exiting the interface appear to be originating from the service node and not the compute node.

Using External DNS for Compute Node Name Resolution

You may want to configure service node(s) to act as NAT gateways for your cluster (see "Service Node Configuration for NAT" on page 80) and to have the host names for the compute nodes in the cluster resolve through external DNS servers.

You need to reserve a large block of IP addresses on your house network. If you configure to resolve via external DNS, you need to do it for both the `ib0` and `ib1` networks, for all node types. In other words, **ALL** `-ib*` addresses need to be provided by external DNS. This includes compute nodes, leader nodes, and service nodes. Careful planning is required to use this feature. Allocation of IP addresses will often require assistance from a network administrator of your site.

Once the IP addresses have been allocated on the house network, you need to tell the SGI Tempo software the IP addresses of the DNS servers on the house network that the SGI Tempo software can query for hostname resolution.

To do this, use the `configure-cluster` tool (see "configure-cluster Command Cluster Configuration Tool" on page 47). The menu item that handles this operation is **Configure External DNS Masters (optional)**.

Some important considerations are, as follows:

- It is important to note that if you choose to use external DNS, you need to make this change **before** discovering anything. The change is **not** retroactive. If you have already discovered some nodes, then turn on external DNS support, the IP addresses assigned by SGI Tempo for the nodes already discovered will remain.
- This is an optional feature that only a small set of customers will need to use. It should not be used by default.
- This feature only makes sense if the compute nodes can reach the house network. This is not the default case for SGI Altix ICE systems.
- It is assumed that you have already configured a service node to act as a NAT gateway to your house network (see "Service Node Configuration for NAT" on page 80) and that the compute nodes have been configured to use that service node as their gateway.

Service Node Configuration for DNS

For information on setting up DNS, see Figure 2-27 on page 66.

Service Node Configuration for NFS

Assuming the installation has either NAT or Gateway operations configured on one or more service nodes, the compute nodes can directly mount the house NFS server's exports (see the `exports(5)` man page).

Procedure 2-11 Service Node Configuration for NFS

To allow the compute nodes to directly mount the house NFS server's exports, perform the following steps:

1. Edit the system admin controller's `/opt/sgi/share/per_host_customization/global/sgi-fstab` file or alternatively an image-specific script. An example of the `sgi-fstab` file is, as follows:

```
sys-admin:/opt/sgi/share/per-host-customization/global # cat sgi-fstab
#!/bin/sh
#
# Set up the compute node's /etc/fstab file.
#
# Modify per your sites requirements.
#
# This script is executed once per-host as part of the install-image operation
# run on the leader nodes. The full path to the per-host iru+slot directory is
# passed in as $1, e.g. /var/lib/sgi/per-host//i2n11.
#

iruslot=$1

cat <${iruslot}/etc/fstab
#          tmpfs          /tmp          tmpfs  defaults        0        0
EOF
```

2. Add the mount point, push the image, and reset the node.
3. The server's export should get mounted. If it is not, use the technique for troubleshooting outlined in "Troubleshooting Service Node Configuration for NAT" on page 82.

Service Node Configuration for NIS for the House Network

This section describes two different ways to configure NIS for service nodes and compute blades when you want to use the house network NIS server, as follows:

- NIS with the compute nodes directly accessing the house NIS infrastructure
- NIS with a service node as a NIS slave server to the house NIS master

The first approach would be used in the case where a service node is configured with network address translation (NAT) or gateway operations so that the compute nodes can access the house network directly.

The second approach may be used if the compute nodes do not have direct access to the house network.

Procedure 2-12 NIS with Compute Nodes Directly Accessing the House NIS Infrastructure

To setup NIS with the compute nodes directly accessing the house NIS infrastructure, perform the following steps:

1. In this case, you do not have to set up any additional NIS servers. Instead, each service node and compute node should be configured to bind to the existing house network servers. The nodes should already have the `ypbind` package installed. The following steps should work with most Linux distributions. You may need to vary them slightly to meet your specific needs.
2. For service nodes, the instructions are very similar to the following:
 - "Setting Up a RHEL Service Node as a NIS Client" on page 103
 - "Setting Up a SLES Service Node as a NIS Client" on page 99

The only difference is that you should configure `yp.conf` to look at the IP address of your house network NIS server and not the leader node as is described in the sections listed, above.

Procedure 2-13 NIS with a Service Node as a NIS Slave Server to the House NIS Master

To setup NIS with a service node as a NIS slave server to the house NIS master, perform the following:

1. Any service nodes that are NOT acting as an NIS slave server can be pointed at the existing house network NIS servers as described in Procedure 2-12, page 85. This is because they have house interfaces.

2. One (or more) service node(s) should be then be configured as NIS slave server(s) to the existing house network NIS Master server.

Since SGI can not anticipate what operating system or release the house network NIS Master server is running, no suggestions on any configuration you need to do to tell it that you are adding new NIS slave servers can be offered, however, some hints could be found in "Setting Up a RHEL Service Node as a NIS Master" on page 98.

Setting Up an NFS Home Server on a Service Node for Your Altix ICE System

This section describes how to make a service node an NFS home directory server for the compute nodes.

Note: Having a single, small server provide filesystems to the whole Altix ICE system could create network bottlenecks that the hierarchical design of Altix ICE is meant to avoid, especially if large files are stored there. Consider putting your home filesystems on an NAS file server. For instructions on how to do this, see "Service Node Configuration for NFS " on page 84.

The instructions in this section assume you are using the service node image provided with the Tempo software. If you are using your own installation procedures or a different operating system, the instructions will not be exact but the approach is still appropriate.

Note: The example below specifically avoids using `/dev/sdX` style device names. This is because `/dev/sdX` device names are not persistent and may change as you adjust disks and RAID volumes in your system. In some situations, you may assume `/dev/sda` is the system disk and that `/dev/sdb` is a data disk; this is **not** always the case. To avoid accidental destruction of your root disk, follow the instructions given below.

When you are choosing a disk, please consider the following:

To pick a disk device, first find the device that is being currently used as root. Avoid re-partitioning the installation disk by accident. To find which device is being used for root, use this command:

```
# ls -l /dev/disk/by-label/sgiroot
lrwxrwxrwx 1 root root 10 2008-03-18 04:27 /dev/disk/by-label/sgiroot ->
../../sda2
```

At this point, you know the `sd` name for your root device is `sda`.

SGI suggests you use `by-id` device names for your data disk. Therefore, you need to find the `by-id` name that is NOT your root disk. To do that, use `ls` command to list the contents of `/dev/disk/by-id`, as follows:

```
# ls -l /dev/disk/by-id
total 0
lrwxrwxrwx 1 root root 9 2008-03-20 04:57 ata-MATSHITADVD-RAM_UJ-850S_HB08_020520 -> ../../hdb
lrwxrwxrwx 1 root root 9 2008-03-20 04:57 scsi-3600508e00000000307921086e156100 -> ../../sda
lrwxrwxrwx 1 root root 10 2008-03-20 04:57 scsi-3600508e00000000307921086e156100-part1 -> ../../sda1
lrwxrwxrwx 1 root root 10 2008-03-20 04:57 scsi-3600508e00000000307921086e156100-part2 -> ../../sda2
lrwxrwxrwx 1 root root 10 2008-03-20 04:57 scsi-3600508e00000000307921086e156100-part5 -> ../../sda5
lrwxrwxrwx 1 root root 10 2008-03-20 04:57 scsi-3600508e00000000307921086e156100-part6 -> ../../sda6
lrwxrwxrwx 1 root root 9 2008-03-20 04:57 scsi-3600508e000000008dced2cfc3c1930a -> ../../sdb
lrwxrwxrwx 1 root root 10 2008-03-20 04:57 scsi-3600508e000000008dced2cfc3c1930a-part1 -> ../../sdb1
lrwxrwxrwx 1 root root 9 2008-03-20 09:57 usb-PepperC_Virtual_Disc_1_0e159d01a04567ab14E72156DB3AC4FA -> .....
```

In the output, above, you can see that ID `scsi-3600508e00000000307921086e156100` is in use by your system disk because it has a symbolic link pointing back to `../../sda`. So do not consider that device. The other disk in the listing has ID `scsi-3600508e000000008dced2cfc3c1930a` and happens to be linked to `/dev/sdb`.

Therefore, you know the `by-id` name you should use for your data is `/dev/disk/by-id/scsi-3600508e000000008dced2cfc3c1930a` because it is not connected with `sda`, which we found in the first `ls` example happened to be the root disk.

Partitioning, Creating, and Mounting Filesystems

Procedure 2-14 Partitioning and Creating Filesystems for an NFS Home Server on a Service Node

The following example uses `/dev/disk/by-id/scsi-3600508e000000008dced2cfc3c1930a` ID as the empty disk on which you will put your data. It is very important that you know this for sure. In "Setting Up an NFS Home Server on a Service Node for Your Altix ICE System", an example is provided that allows you to determine where your root disk is located so you can avoid accidentally destroying it. Remember, in some cases, `/dev/sdb` will be the root drive and `/dev/sda` or `/dev/sdc` may be the data drive.

Please confirm that you have selected the right device, and use the persistent device name to help prevent accidental overwriting of the root disk.

Note: Steps 1 through 7 of this procedure are performed on the service node. Steps 8 and 9 are performed from the system admin controller (admin node).

To partition and create filesystems for an NFS home server on a service node, perform the following steps:

1. Use the `parted(8)` utility, or some other partition tool, to create a partition on `/dev/disk/by-id/scsi-3600508e0000000008dced2cfc3c1930a`. The following example makes one filesystem out of the disk. You can use the `parted` utility interactively or in a command-line driven manner.
2. Make a new `msdos` label, as follows:

```
# parted /dev/disk/by-id/scsi-3600508e0000000008dced2cfc3c1930a mklabel msdos
```

3. Find the size of the disk, as follows:

```
# # parted /dev/disk/by-id/scsi-3600508e0000000008dced2cfc3c1930a print
Disk geometry for /dev/sdb: 0kB - 249GB
Disk label type: msdos
Number  Start   End     Size    Type    File system  Flags
Information: Don't forget to update /etc/fstab, if necessary.
```

4. Create a partition that spans the disk, as follows:

```
# # parted /dev/disk/by-id/scsi-3600508e0000000008dced2cfc3c1930a mkpart
primary ext2 0 249GB
Information: Don't forget to update /etc/fstab, if necessary.
```

5. Issue the following command to cause the `/dev/disk/by-id` partition device file is in place and available for use with the `mkfs` command that follows:

```
# udevtrigger
```

6. Create a filesystem on the disk. You can choose the filesystem type.

Note: The `mkfs.ext3` command takes more than 10 minutes to create a single 500GB filesystem using default `mkfs.ext3` options. If you do not need the number of inodes created by default, use the `-N` option to `mkfs.ext3` or other options that reduce the number of inodes. The following example creates 20 million inodes. XFS filesystems can be created in much shorter time.

An `ext3` example is, as follows:

```
# mkfs.ext3 -N 20000000 /dev/disk/by-id/scsi-3600508e0000000008dced2cfc3c1930a-part1
```

An `xfs` example is, as follows:

```
# mkfs.xfs /dev/disk/by-id/scsi-3600508e0000000008dced2cfc3c1930a-part1
```

7.

Note: RHEL based distros normally use the `LABEL=` syntax in `/etc/fstab`.

Add the newly created filesystem to the server's `fstab` file and mount it. Ensure that the new filesystem is exported and that the NFS service is running, as follows:

a. Append the following line to your `/etc/fstab` file.

```
/dev/disk/by-id/scsi-3600508e0000000008dced2cfc3c1930a-part1 /home ext3 defaults 1
```

Note: If you are using XFS, replace `ext3` with `xfs`. This example uses the `/dev/disk/by-id` path for the device and not a `/dev/sd` device.

b. Mount the new filesystem (the `fstab` entry, above, enables it to mount automatically the next time the system is rebooted), as follows:

```
# mount -a
```

c.

Note: In some distros, the NFS server init script is simply `"nfs"`

Make sure the NFS server service is enabled, as follows:

```
# chkconfig nfsserver on
# /etc/init.d/nfsserver restart
```

Note: Steps 8 and 9 are performed from the system admin controller (admin node).

8. The following steps describe how to mount the home filesystem on the compute nodes, as follows:

Note: SGI recommends that you always work on clones of the SGI-supplied compute image so that you always have a base to copy to fall back to if necessary. For information on cloning a compute node image, see "Customizing Software Images" on page 137.

- a. Make a mount point in the blade image. In the following example, `/home` already is a mount point. If you used a different mount point, you need to do something similar to the following on the system admin controller. Note that the rest of the examples will resume using `/home`.

```
# mkdir /var/lib/systemimager/images/compute-sles10sp2-clone/my-mount-point
```

- b. Add the `/home` filesystem to the compute nodes. SGI supplies an example script for managing this. You just need to add your new mount point to the `sgi-fstab` post-host-customization script.
- c. Use a text editor to edit the following file:

```
/opt/sgi/share/per-host-customization/global/sgi-fstab
```

- d. Insert the following line just before the "EOF" line in `sgi-fstab` file:

```
service0-ib1:/home /home nfs hard 0 0
```

Note: In order to maximize performance, SGI advises that the `ib0` fabric be used for all MPI traffic. The `ib1` fabric is reserved for storage related traffic.

- e. Use the `cimage` command to push the update to the rack leader controllers serving each compute node, as follows:

```
# cimage --push-rack compute-sles10sp2-clone "r*"
```

Using `--push-rack` on an image that is already on the rack leader controllers has the simple affect of updating them with the change you made above. For more information on using the `cimage`, see "cimage Command" on page 141.

9. When you reboot the compute nodes, they will mount your new home filesystem.

For information on centrally managed user accounts, see "Setting Up a NIS Server for Your Altix ICE System" on page 95. It describes NIS master set up. In this design, the master server residing on the service node provides the filesystem and the NIS slaves reside on the rack leader controllers. If you have more than one home server, you need to export all home filesystems on all home servers to the server acting as the NIS master. You also need to export the filesystems to the NIS master using the `no_root_squash exports` flag.

Home Directories on NAS

If you want to use NAS server for scratch storage or make home filesystems available on NAS, you can follow the instructions in "Setting Up an NFS Home Server on a Service Node for Your Altix ICE System" on page 86. In this example, you need to replace `service0-ib1` with the `ib1` InfiniBand host name for the NAS server and you need to know where on the NAS server the home filesystem is mounted to craft the `sgi-fstab` script properly.

Service Node NFS Server Alternate: Re-exporting House NFS Servers

Note: That the `nfs-server` package on the download page is currently only available for SLES. This section only applies to SLES.

All operations are from the service node acting as the NFS proxy except where noted.

This procedure described in this section does not require the NAT/gateway operations and may be more efficient. This method does require that an unsupported package be installed. It is available from the SGI support page as described below.

Procedure 2-15 Service Node NFS Server Alternate: Re-exporting House NFS Servers

To set up a service node for re-exporting house NFS servers, perform the following steps:

1. Download the unsupported `nfs-server` RPM from the SGI support server:

- a. Login to Supportfolio (<https://support.sgi.com/>)
 - b. Click on **Browse Collections**.
 - c. Click on **Download Cool Software**.
 - d. Find the `nfs-server` package.
2. Remove `nfs-utils` on the service node, as follows:

```
# rpm -e nfs-utils
```
 3. Install the newly downloaded `nfs-server` RPM, as follows:

```
# rpm -Uvh /usr/src/packages/RPMS/x86_64/nfs-server-2.2beta51-246*.x86_64.rpm
```
 4. Edit the `/etc/sysconfig/nfs` file and change the `REEXPORT_NFS` option to "yes"
 5. Enable the NFS server at start-up, as follows:

```
# chkconfig nfsserver on
```
 6. Start it on the service node, as follows:

```
# rcnfsserver start
```
 7. Add the mount to the "house nfs server" on to the service node acting as the proxy for NFS. An example `fstab` line is, as follows:

```
house-server:/mirror /mirror nfs defaults 0 0
```
 8. Ensure the filesystem is mounted, as follows:

```
# mount -a
```
 9. Export the filesystem by adding a line to `/etc/exports` similar to the example. You also need to change the subdomain to match your site's.

```
/mirror *.ice.americas.sgi.com(ro, sync)
```
 10. Now configure the compute blades to mount this directory from the service node acting as a proxy. In this example, it is assumed that `service0` is the node from which the blades will mount `/mirror`. To do this, add a line similar to this to the following before 'EOF' in

`/opt/sgi/share/per-host-customization/global/sgi-fstab` file. This file is located on the system admin controller (admin node).

```
service0-ib1:/mirror /mirror nfs hard 0 0
```

11. Recall that the mount point for the compute blades needs to exist. Therefore, you might need to create a directory within the systemimager image on the admin node, for example, `mkdir`

```
/var/lib/systemimager/images/compute-sles10sp2/mirror.
```

12. Tell NFS about the exports change, as follows:

```
# rcnfsserver reload
```

13. Earlier, in this procedure, you changed the `sgi-fstab` per-host customization script and created a mount point within one or more compute blade systemimager images. From the admin node, you need to push the images so they are available on the leader nodes serving your racks. The compute blades in the rack in question should be shut down prior to running this command. You should do this for all compute images you may have and for all racks.

```
# cimage --push-rack compute-sles10sp2 r1
```

14. Now you may boot up your compute blades. The filesystem will now be mounted on each one. When you access `/mirror` on a compute blade, the service node proxy NFS server then accesses its `/mirror`, which contacts the actual NFS server on the house network.

RHEL Service Node House Network Configuration

If you plan to put your service node on the house network, you need to configure it for networking. For this, you may use the `system-config-network` command. It is better to use the graphical version of the tool if you are able. Use the `ssh -X` command from your desktop to connect to the admin node and then again to connect to the service node. This should redirect graphics over to your desktop.

Some helpful hints are, as follows:

- On service nodes, the cluster interface is `eth0`. Therefore, do not configure this interface as it is already configured for the cluster network.
- Do not make the public interface a `dhcp` client as this can overwrite the `/etc/resolv.conf` file.

- Do not configure name servers, the name server requests on a service node are always directed to the admin leader nodes for resolution. If you wish to resolve network addresses on your house network, just be sure to enable the **House DNS Resolvers** using `configure-cluster` command on the admin node.
- Do not configure or change the search order, as this again could adjust what cluster management has placed in the `/etc/resolv.conf` file.
- Do not change the host name using the RHEL tools. You can change the hostname using the `cadmin` tool on the admin node.
- After configuring your house network interface, you can use the `ifup ethX` command to bring the interface up. Replace `X` with your house network interface.
- If you wish this interface to come up by default when the service node reboots, be sure `ONBOOT` is set to `yes` in `/etc/sysconfig/network-scripts/ifcfg-ethX` (again, replace `X` with the proper value). The graphical tool allows you to adjust this setting while the text tool does not.
- If you happen to wipe out the `resolv.conf` file by accident and end up replacing it, you may need to issue this command to ensure that DNS queries work again:

```
# nscd --invalidate hosts
```

Setting Up a NIS Server for Your Altix ICE System

This section describes how to set up a network information service (NIS) server running SLES10 for your Altix ICE system. If you would like to use an existing house network NIS server, see "Service Node Configuration for NIS for the House Network" on page 85. This section covers the following topics:

- "Setting Up a NIS Server Overview" on page 96
- "Setting Up a SLES Service Node as a NIS Master" on page 96
- "Setting Up a RHEL Service Node as a NIS Master" on page 98
- "Setting Up a SLES Service Node as a NIS Client" on page 99
- "Setting up a SLES Rack Leader Controller as a NIS Slave Server and Client" on page 100
- "Setting up a RHEL Rack Leader Controller as a NIS Slave Server and Client" on page 101
- "Setting Up a RHEL Service Node as a NIS Client" on page 103

- "Setting up RHEL Compute Nodes to be NIS Clients" on page 104
- "NAS Configuration for Multiple IB Interfaces" on page 106
- "Setting up the SLES Compute Nodes to be NIS Clients" on page 105
- "Creating User Accounts" on page 108
- "Tasks You Should Perform After Changing a Rack Leader Controller" on page 109

Setting Up a NIS Server Overview

In the procedures that follow in this section, here are some of the tasks you need to perform and system features you need to consider:

- Make a service node the NIS master
- Make the rack leader controllers (leader nodes) the NIS slave servers
- Do **not** make the system admin controller as the NIS master because it may not be able to mount all of the storage types. Having the storage mounted on the NIS master server makes it far less complicated to add new accounts using NIS.
- If multiple service nodes provide home filesystems, the NIS master should mount all remote home filesystems. They should be exported to the NIS master service node with the `no_root_squash export` option. The example in the following section assumes a single service node with storage and that same node is the NIS master.
- No NIS traffic goes over the InfiniBand network.
- Compute node NIS traffic goes over Ethernet, not InfiniBand, by way of using a the `lead-eth` server name in the `yp.conf` file. This design feature prevents NIS traffic from affecting the InfiniBand traffic between the compute nodes.

Setting Up a SLES Service Node as a NIS Master

This section describes how to set up a service node as a NIS master. This section only applies to service nodes running SLES10.

Procedure 2-16 Setting Up a SLES Service Node as a NIS master

To set up a SLES service node as a NIS master, from the service node, perform the following steps:

Note: These instructions use the text-based version of YaST. The graphical version of YaST may be slightly different.

1. Start up YaST, as follows:

```
# yast nis_server
```

2. Choose **Create NIS Master Server** and click on **Next** to continue.
3. Choose an NIS domain name and place it in the NIS Domain Name window. This example, uses **ice**.
 - a. Select **This host is also a NIS client**.
 - b. Select **Active Slave NIS server exists**.
 - c. Select **Fast Map distribution**.
 - d. Select **Allow changes to passwords**.
 - e. Click on **Next** to continue.
4. Set up the NIS master server slaves.

Note: You are now in the **NIS Master Server Slaves Setup**. Just now, you can enter the already defined rack leader controllers (leader nodes) here. If you add more leader nodes or re-discover leader nodes, you will need to change this list. For more information, see "Tasks You Should Perform After Changing a Rack Leader Controller" on page 109.

5. Select **Add** and enter **r1lead** in the **Edit Slave** window. Enter any other rack leader controllers you may have just like above. Click on **Next** to continue.
6. You are now in **NIS Server Maps Setup**. The default selected maps are okay. Avoid using the **hosts** map (not selected by default) because can interfere with Altix ICE system operations. Click on **Next** to continue.
7. You are now in **NIS Server Query Hosts Setup**. Use the default settings here. However, you may want to adjust settings for security purposes. Click on **Finish** to continue.

At this point, the NIS master is configured. Assuming you checked the **This host is also a NIS client box**, the service node will be configured as a NIS client to itself and start `yp ypbind` for you.

Setting Up a RHEL Service Node as a NIS Master

This section describes how to set up a service node as a NIS master. This section only applies to service nodes running RHEL 5. 2 (or later).

If you have enabled the firewall on the service node, you will need to ensure the firewall allows NIS traffic to pass. That is beyond the scope of this document. By default, service nodes have the firewall disabled.

Procedure 2-17 Setting Up a RHEL Service Node as a NIS master

To set up a RHEL service node as a NIS master, from the service node, perform the following steps:

1. Log in to the service node as root and turn on these services:

```
# chkconfig ypserv on
# chkconfig yppasswdd on
```

2. Choose a NIS domain name and place it in the `/etc/sysconfig/network` file. For example:

```
# echo "NISDOMAIN=ice" >> /etc/sysconfig/network
```

The NIS domain will be set using this value when `ypbind` or `ypserv` is started for the first time.

3. Change `NOPUSH=true` to `NOPUSH=false` in `/var/yp/Makefile`. This will ensure that slave servers get map updates.
4. Start up the NIS server daemon, as follows:

```
# /etc/init.d/ypserv start
```

5. Configure the `yp` master server, as follows:

```
# /usr/lib64/yp/ypinit -m
```

6. It will prompt you for the hostnames that will act as NIS servers. It automatically includes the service node acting as the master in the list. At this time, enter the

hostnames for the leader nodes starting with `r1lead`. Enter `Ctrl-d` when done as instructed by the tool.

7. Start up `yppasswdd`, as follows:

```
# /etc/init.d/yppasswdd start
```

8. NIS Master Servers are also NIS Clients. However, they are configured to look at themselves for NIS. Therefore, follow these steps to make the NIS Master Server an NIS client to itself:

- a. Make `ypbind` start at bootup, as follows:

```
# chkconfig ypbind on
```

- b. Make the NIS master service node a client of itself, as follows:

```
# echo "ypserver localhost" >> /etc/yp.conf
```

- c. Start `ypbind`, as follows:

```
# /etc/init.d/ypbind start
```

Setting Up a SLES Service Node as a NIS Client

This section describes how to use YaST to set up your other service nodes to be broadcast binding NIS clients. This section only applies to service nodes running SLES10.

Note: You do not do this on the NIS Master service node that you already configured as a client in "Setting Up a SLES Service Node as a NIS Master" on page 96.

Procedure 2-18 Setting Up a SLES Service Node as a NIS Client

To set up a service node as a NIS client, perform the following steps:

1. Enable `ypbind`, perform the following:

```
# chkconfig ypbind on
```

2. Set the default domain (already set on NIS master). Change `ice` (or whatever domain name you choose above) to be the NIS domain for your Altix ICE system, as follows:

```
# echo "ice" > /etc/defaultdomain
```

3. In order to ensure that no NIS traffic goes over the IB network, SGI does **not** recommend using NIS broadcast binding on service nodes. You can list a few leader nodes the in `/etc/yp.conf` file on non-NIS-master service nodes. The following is an example `/etc/yp.conf` file. Add or remove rack leader nodes as appropriate. Having more entries in the list allows for some redundancy. If `r1lead` is hit by excessive traffic or goes down, `ypbind` can use the next server in the list as its NIS server. SGI does not suggest listing other service nodes in `yp.conf` file because all resolvable names for service nodes on service nodes use IP addresses that go over the InfiniBand network. For performance reasons, it is better to keep NIS traffic off of the InfiniBand network.

```
ypserver r1lead
ypserver r2lead
```

4. Start the `ypbind` service, as follows:

```
# rcypbind start
```

The service node is now bound.

5. Add the NIS include statement to the end of the password and group files, as follows:

```
# echo "+:::" >> /etc/group
# echo "+:::::" >> /etc/passwd
# echo "+" >> /etc/shadow
```

Setting up a SLES Rack Leader Controller as a NIS Slave Server and Client

This section provides two sets of instructions for setting up rack leader controllers (leader nodes) as NIS slave servers. It is possible to make all these adjustments to the leader image in `/var/lib/systemimager/images`. Currently, SGI does not recommend using this approach.

Note: Be sure the InfiniBand interfaces are up and running before proceeding because the rack leader controller gets its updates from the NIS Master over the InfiniBand network. If you get a "can't enumerate maps from service0" error, check to be sure the InfiniBand network is operational.

Procedure 2-19 Setting up a Rack Leader Controller as a NIS Slave Server and Client

Use the following set of commands from the system admin controller (admin node) to set up a rack leader controller (leader node) as a NIS slave server and client.

Note: Replace `ice` with your NIS domain name and `service0` with the service node you set up as the master server.

```
admin:~ # cexec --head --all chkconfig ypserv on
admin:~ # cexec --head --all chkconfig ypbind on
admin:~ # cexec --head --all chkconfig portmap on
admin:~ # cexec --head --all chkconfig nscd on
admin:~ # cexec --head --all rcportmap start
admin:~ # cexec --head --all "echo ice > /etc/defaultdomain"
admin:~ # cexec --head --all "ypdomainname ice"
admin:~ # cexec --head --all "echo ypserver service0 > /etc/yp.conf"
admin:~ # cexec --head --all /usr/lib/yp/ypinit -s service0
admin:~ # cexec --head --all rcportmap start
admin:~ # cexec --head --all rcypserv start
admin:~ # cexec --head --all rcypbind start
admin:~ # cexec --head --all rcnscd start
```

Setting up a RHEL Rack Leader Controller as a NIS Slave Server and Client

This section describes how to set up a RHEL rack leader controller (leader node) as a NIS slave server and client.

Procedure 2-20 Setting Up a RHEL Service Node as a NIS Client

To set up a RHEL rack leader controller (leader node) as a NIS slave server and client, perform the following:

1. Log in to the leader node(s) as root enable `ypserv`, as follows:

```
# chkconfig ypserv on
```

2. Choose a NIS domain name and place it in the `/etc/sysconfig/network` file. For example:

```
# echo "NISDOMAIN=ice" >> /etc/sysconfig/network
```

The NIS domain will be set using this value when `ypbind` or `ypserv` is started for the first time.

3. Start the `yp` server, as follows:

```
# /etc/init.d/ypserv start
```

4. For each leader node, log on using the `ssh` command and run this command replacing `service0` with the hostname of the service node acting as the NIS master, as follows:

```
# /usr/lib64/yp/ypinit -s service0
```

5. Enable `ypbind` to make this a NIS client, as follows:

```
# chkconfig ypbind on
```

6. Configure the leader node to be a NIS client to itself, as follows:

```
# echo "ypserver localhost" >> /etc/yp.conf
```

7. Start up `ypbind`, as follows:

```
# /etc/init.d/ypbind start
```

8. Optionally, set up the password, shadow, and group files with NIS includes, as follows:

Note: SGI does not suggest that users log in to leader nodes, however, it is sometimes helpful for their accounts to show up there. Therefore, this is OPTIONAL.

```
# echo "+:::" >> /etc/group
# echo "+:::::" >> /etc/passwd
# echo "+" >> /etc/shadow
```

9. Optionally, if you elected to perform the above step, then you should ensure NIS is enabled in `/etc/nsswitch.conf` for `passwd`, `shadow`, and `group`. The lines would look like this:

```
passwd:    files nis
shadow:    files nis
group:     files nis
```

Setting Up a RHEL Service Node as a NIS Client

This section describes how to configure service nodes that are not your NIS Master to be NIS clients.

Procedure 2-21 Setting Up a RHEL Service Node as a NIS Client

To configure service nodes that are not your NIS Master to be NIS clients, perform the following:

1. Make it so `ypbind` starts at bootup, as follows:

```
# chkconfig ypbind on
```

2. Configure the NIS domain to the same NIS domain that the NIS master server is setup as, as follows:

```
# echo "NISDOMAIN=ice" >> /etc/sysconfig/network
```

3. In order to ensure that no NIS traffic goes over the IB network, SGI does not recommend using NIS broadcast binding on service nodes. You can list a few leader nodes in the `/etc/yp.conf` file on non-NIS-master service nodes. The following is an example `/etc/yp.conf` file. Add or remove rack leader nodes as appropriate. Having more entries in the list allows for some redundancy. If `r1lead` experiences excessive traffic or goes down, `ypbind` can use the next server in the list as its NIS server. SGI does not suggest listing other service nodes in `yp.conf` file because all resolvable names for service nodes on service nodes use IP addresses that go over the InfiniBand network. For performance reasons, it is better to keep NIS traffic off of the InfiniBand network.

```
ypserver r1lead  
ypserver r2lead
```

4. Start `ypbind` up, as follows:

```
# /etc/init.d/ypbind start
```

5. Set up the password, shadow, and group files with NIS includes, as follows:

```
# echo "+:::" >> /etc/group  
# echo "+:::::" >> /etc/passwd  
# echo "+" >> /etc/shadow
```

6. Enable NIS lookups in the `/etc/nsswitch.conf` file. Ensure NIS is enabled in `/etc/nsswitch.conf` for `passwd`, `shadow`, and `group`, as follows:

```
passwd:    files nis
shadow:    files nis
group:     files nis
```

Setting up RHEL Compute Nodes to be NIS Clients

This section shows how to set up RHEL compute blades as NIS clients. The instructions work on the actual images, then push them out.

Procedure 2-22 Setting up RHEL Compute Nodes to be NIS Clients

To set up RHEL compute blades as NIS clients, perform the following:

1. SGI suggests that you operate on a cloned image, preserving the SGI default images as a reference. See "Customizing Software On Your SGI Altix ICE System" on page 134.

In RHEL, the NIS domain is set up in `/etc/sysconfig/network`. However, this is a file that Tempo normally creates on its own in per-host-customization. Therefore, to modify this file, we have to create a customization script of our own that appends the value. This script can be simple. The script filename should sort alphabetically after "sgi-hostname" to ensure it executes after the `sgi-hostname` customization script. For example, create the following file on the admin node assuming the NIS domain is 'ice' and the compute node image is `compute-rhel52-clone`, as follows:

```
# vi /opt/sgi/share/per-host-customization/global/yp-setup
```

Put in the following two lines in the file, then save it, as follows:

```
iruslot=$1
echo "NISDOMAIN=ice" >> ${iruslot}/etc/sysconfig/network
```

2. Change permissions on the file to be executable and readable, as follows:

```
# chmod a+rx /opt/sgi/share/per-host-customization/global/yp-setup
```

3. Set up compute nodes to get their NIS service from their rack leader controller (fix the domain name as appropriate), as follows:

```
# echo "ypserver lead-eth" > /var/lib/systemimager/images/compute-rhel52-clone/etc/yp.conf
```

4. Enable the ypbind service, using the chroot command, as follows:

```
# chroot /var/lib/systemimager/images/compute-rhel52-clone chkconfig ypbind on
```

5. Set up the password, shadow, and group files with NIS includes, as follows:

```
# echo "+:::" >> /var/lib/systemimager/images/compute-rhel52-clone/etc/group
# echo "+:::::" >> /var/lib/systemimager/images/compute-rhel52-clone/etc/passwd
# echo "+" >> /var/lib/systemimager/images/compute-rhel52-clone/etc/shadow
```

6. Enable NIS lookups in nsswitch.conf. On a compute node, do this by ensuring the nsswitch.conf file in the image you wish to modify has the lines as they are shown below. The filename would be, assuming image name compute-rhel52-clone, /var/lib/systemimager/images/compute-rhel52-clone/etc/nsswitch.conf:

```
passwd:    files nis
shadow:    files nis
group:     files nis
```

7. Push out the updates using the cimage command, as follows:

```
# cimage --push-rack compute-rhel52-clone "r*"
```

Setting up the SLES Compute Nodes to be NIS Clients

This section describes how to set up the compute nodes to be NIS clients. You can configure NIS on the clients to use a server list that only contains the their rack leader controller (leader node). All operations are performed from the system admin controller (admin node).

Procedure 2-23 Setting up the Compute Nodes to be NIS Clients

To set up the compute nodes to be NIS clients, perform the following steps:

1. Create a compute node image clone. SGI recommends that you always work with a clone of the compute node images. For information on how to clone the compute node image, see "Customizing Software Images" on page 137.
2. Change the compute nodes to use the cloned image/kernel pair, as follows:

```
admin:~ # cimage --set compute-sles10sp2-clone 2.6.16.46-0.12-smp "r*i*n*"
```

3. Set up the NIS domain, as follows (ice in this example):

```
admin:~ # echo "ice" > /var/lib/systemimager/images/compute-sles10sp2-clone/etc/defaultdomain
```

4. Set up compute nodes to get their NIS service from their rack leader controller (fix the domain name as appropriate), as follows:

```
admin:~ # echo "ypserver lead-eth" > /var/lib/systemimager/images/compute-sles10sp2-clone/etc/yp.conf
```

5. Enable the ypbind service, using the chroot command, as follows:

```
admin:~# chroot /var/lib/systemimager/images/compute-sles10sp2-clone chkconfig ypbind on
```

6. Set up the password, shadow, and group files with NIS includes, as follows:

```
admin:~# echo "+:::" >> /var/lib/systemimager/images/compute-sles10sp2-clone/etc/group
admin:~# echo "+:::::" >> /var/lib/systemimager/images/compute-sles10sp2-clone/etc/passwd
admin:~# echo "+" >> /var/lib/systemimager/images/compute-sles10sp2-clone/etc/shadow
```

7. Push out the updates using the cimage command, as follows:

```
admin:~ # cimage --push-rack compute-sles10sp2-clone "r*"
```

NAS Configuration for Multiple IB Interfaces

The NAS cube needs to get configured with each InfiniBand fabric interface in a separate subnet. These fabrics will be separated from each other logically, but attached to the same physical network. For simplicity, this guide assumes that the `-ib1` fabric for the compute nodes has addresses assigned in the `10.149.0.0/16` network. This guide also assumes the lowest address the cluster management software has used is `10.149.0.1` and the highest is `10.149.1.3` (already assigned to the NAS cube).

For the NAS cube, you need to configure the large physical network into four, smaller subnets, each of which would be capable of containing all the nodes and service nodes. It will have subnets `10.149.0.0/18`, `10.149.64.0/18`, `10.149.128.0/18`, and `10.149.192.0/18`.

After the discovery of the storage node has happened, SGI personnel will need to log onto the NAS box and change the network settings to use the smaller subnets, and then define the other three adapters with the same offset within the subnet; for example: Initial configuration of the storage node had set `ib0` fabric's IP to `10.149.1.3 netmask 255.255.0.0`. After the addresses are changed, `ib0=10.149.1.3:255.255.192.0`, `ib1=10.149.65.3:255.255.192.0`, `ib2=10.149.129.3:255.255.192.0`, `ib3=10.149.193.3:255.255.192.0`. The NAS cube should now have all four adapter connections connected to the fabric with IP addresses which can be pinged from the service node.

Note: The service nodes and the rack leads will remain in the `10.149.0.0/16` subnet.

For the compute blades, log into the admin node and modify `/opt/sgi/share/per-host-customization/global/sgi-setup-ib-configs` file. Following the line `iruslot=${1}`, insert:

```
# Compute NAS interface to use
IRU_NODE=`basename ${iruslot}`
RACK=`cminfo --rack`
RACK=$(( ${RACK} - 1 ))
IRU=`echo ${IRU_NODE} | sed -e s/i// -e s/n.*//`
NODE=`echo ${IRU_NODE} | sed -e s/.*/n//`
POSITION=$(( ${IRU} * 16 + ${NODE} ))
POSITION=$(( ${RACK} * 64 + ${POSITION} ))
NAS_IF=$(( ${POSITION} % 4 ))
NAS_IPS[0]="10.149.1.3"
NAS_IPS[1]="10.149.65.3"
NAS_IPS[2]="10.149.129.3"
NAS_IPS[3]="10.149.193.3"
```

Then following the line `iruslot/etc/opt/sgi/cminfo` add:

```
IB_1_OCT12=`echo ${IB_1_IP} | awk -F "." '{ print $1 "." $2 }'`
IB_1_OCT3=`echo ${IB_1_IP} | awk -F "." '{ print $3 }'`
IB_1_OCT4=`echo ${IB_1_IP} | awk -F "." '{ print $4 }'`
IB_1_OCT3=$(( ${IB_1_OCT3} + ${NAS_IF} * 64 ))
IB_1_NAS_IP="${IB_1_OCT12}.${IB_1_OCT3}.${IB_1_OCT4}"
```

Then change the `IPADDR='${IB_1_IP}'` and `NETMASK='${IB_1_NETMASK}'` lines to the following:

```
IPADDR='${IB_1_NAS_IP}'
NETMASK='255.255.192.0'
```

Then add the following to the end of the file:

```
# ib-1-vlan config
cat << EOF >iruslot/etc/sysconfig/network/ifcfg-vlan1
# ifcfg config file for vlan ib1
BOOTPROTO='static'
BROADCAST=''
ETHTOOL_OPTIONS=''
IPADDR='${IB_1_IP}'
MTU=''
NETMASK='255.255.192.0'
```

```
NETWORK=' '  
REMOTE_IPADDR=' '  
STARTMODE='auto'  
USERCONTROL='no'  
ETHERDEVICE='ib1'  
EOF  
if [ $NAS_IF -eq 0 ]; then  
    rm $iruslot/etc/sysconfig/network/ifcfg-vlan1  
fi
```

To update the `fstab` for the compute blades, edit `/opt/sgi/share/per-host-customization/global/sgi-fstab` file. Perform the equivalent steps as above to add the `# Compute NAS` interface to use section into this file. Then to specify mount points, add lines similar to the following example:

```
# SGI NAS Server Mounts  
${NAS_IPS[${NAS_IF}]}:/mnt/data/scratch /scratch nfs defaults 0 0
```

Creating User Accounts

The example used in this section assumes that the home directory is mounted on the NIS Master service and that the NIS master is able to create directories and files on it as root. The following example use command line commands. You could also create accounts using YaST.

Procedure 2-24 Creating User Accounts on a NIS Server

To create user accounts on the NIS server, perform the following steps:

1. Log in to the NIS Master service node as root.
2. Issue a `useradd` command similar to the following:

```
# useradd -c "Joe User" -m -d /home/juser juser
```

3. Provide the user a password, as follows:

```
# passwd juser
```

4. Push the new account to the NIS servers, as follows:

```
# cd /var/yp && make
```

Tasks You Should Perform After Changing a Rack Leader Controller

If you add or remove a rack leader controller (leader node), for example, if you use `discover` command to discover a new rack of equipment, you will need to configure the new rack leader controller to be an NIS slave server as described in "Setting Up a SLES Service Node as a NIS Client" on page 99.

In addition, you need to add or remove the leader from the `/var/yp/ypservers` file on NIS Master service node. Remember to use the `-ib1` name for the leader, as service nodes cannot resolve `r2lead` style names. For example, use `r2lead-ib1`.

```
# cd /var/yp && make
```

Installing SGI Tempo Patches and Updating SGI Altix ICE Systems

This section describes how to update the software on an SGI Altix ICE system.

Overview

SGI supplies updates to SGI Tempo software via the SGI update server at <https://update.sgi.com/>. Access to this server requires a Supportfolio login and password. Access to SUSE Linux Enterprise Server updates requires a Novell login account and registration.

The initial installation process for the SGI Altix ICE system set up a number of package repositories in the `/tftpboot` directory on the admin node. The SGI Tempo related packages are in directories located under the `/tftpboot/sgi` directory. If the cluster is configured with SUSE Linux Enterprise Linux (SLES), then SLES packages are in the `/tftpboot/distro/sles10sp2`. If the cluster is configured with Red Hat Enterprise Linux (RHEL), then the RHEL packages are in `/tftpboot/distro/RHEL5.2`.

When SGI releases updates, you may run `sync-repo-updates` (described later) to download the updated packages that are part of a patch. The `sync-repo-updates` command automatically positions the files properly under `/tftpboot`.

Once the local repositories contain the updated packages, it is possible to update the various SGI Altix ICE admin, leader, and managed service node images using the `installman` command. The `installman` command is used for all package updates including those within images, running nodes, including the admin node itself.

For additional information on updating your system, see "Upgrading from SGI ProPack 6 SP1 to SGI ProPack 6 SP2" on page 117.

There is a small amount of preparation required, in order to setup an SGI Altix ICE system, so that updated packages can be downloaded from the SGI update server and the Linux distro server and then installed with the `cinstallman` command.

The following sections describe these steps, as follows:

- "Update the Local Package Repositories on the Admin Node" on page 110
- "Installing Updates on Running Admin, Leader, and Service Nodes " on page 114

Update the Local Package Repositories on the Admin Node

This section explains how to update the local product package repositories needed to share updates on all of the various nodes on an SGI Altix ICE system.

Update the SGI Package Repositories on the Admin Node

SGI provides a `sync-repo-updates` script to help keep your local package repositories on the admin node synchronized with available updates for the SGI Tempo, SGI Foundation, SGI ProPack for Linux and SLES products. The script is located in `/opt/sgi/sbin/sync-repo-updates` on the admin node.

The `sync-repo-updates` script requires your Supportfolio user name and password. You can supply this on the command line or it will prompt you for it. With this login information, the script contacts the SGI update server and downloads the updated packages into the appropriate local package repositories.

For SLES, if you installed and configured the `yup` tool as described in "Update the SLES Package Repository" on page 111, the `sync-repo-updates` script will also download any updates to SLES from the Novell update server. When all package downloads are complete, the script updates the repository metadata.

For RHEL, if you configured the `RHN` tool as described in "Update the RHEL Package Repository" on page 113, the `sync-repo-updates` script will also download any updates to RHEL from the Red Hat update server. When all package downloads are complete, the script updates the repository metadata.

Once the script completes, the local package repositories on the admin node should contain the latest available package updates and be ready to use with the `cinstallman` command.

Note: You can use the `crepo` command to set up custom repositories. If you add packages to these custom repositories later, you need to use the `yume --prepare --repo` command on the custom repository so that the metadata is up to date. If you fail to do this, the `yum/yume/cinstallman` command may not be able to see your new packages.

Update the SLES Package Repository

As described in "Update the SGI Package Repositories on the Admin Node" on page 110, it is possible to download updates for SUSE Linux Enterprise Server to the local SLES package repository on the admin node. Tools like YaST Online Update and `rug(1)` are designed to update a running system, but not well suited to managing a repository of packages for use within a clustered environment.

You can use the `yup(1)` tool to mirror the update packages from Novell's update servers.

The `yup` tool stores packages downloaded from the Novell update server in a directory structure that is not compatible with the local SGI Tempo, SGI ProPack and SLES package repositories located on the admin node. After `yup` is run, the packages need to be copied to the appropriate SLES repository.

If you plan to use the SGI-supplied `/opt/sgi/sbin/sync-repo-updates` script to keep repositories up to date, you will see that it copies the packages retrieved via `yup` in to the appropriate SLES package repository and then updates the repository metadata. If you plan to use your own customized scripts, please use the `sync-repo-updates` script, as an example.

Before you can download packages via `yup`, you must register the admin node with Novell. The following steps explain how to register the admin node with Novell using YaST, although the general steps are the same for graphical `yast2`:

1. Run the `/sbin/yast` command and select **Software -> Novell Customer Center Configuration**
2. You will be prompted to enter your email address and registration code, if you have it.

Note: If you do not have your registration code(s) handy, you may proceed and Novell will provide you with temporary access; however, you will need to register your SLES purchase in the Novell Customer Center (<http://www.novell.com/center>) in order to continue to get access to updates. If you already have a Novell account, use the email address associated with your Novell account here.

Sometimes the registration process will error out with a "failed to contact the server" message. This is due to an issue with unknown/untrusted key error caused by the manner in which the initial admin node images are created. Repeat step 3, you will not have to fill in the field forms again, and then `yast` will prompt you to import the keys. Once the keys are imported, you should be able to complete this step.

3. As part of the registration process, `yast` will add an install source for updates. **DO NOT TRY TO USE YaST ONLINE UPDATE.** At the end of the Novell Customer Center Configuration module, `yast` will display information on how to create a Novell account. If you do not already have a Novell account, go create one per the instructions.

Now that you have created a Novell account and registered your admin node with Novell, you can configure `yup` to mirror the SLES update packages. The following instructions cover only the essential steps required to mirror the SLES updates; the `yup` man pages have more detailed information on available options:

1. Edit `/etc/sysconfig/yup` file and modify the following variables:

- `YUP_DEST_DIR`

Set this variable to `/var/spool/yup-updates`. This value is referenced by the `/opt/sgi/sbin/sync-repo-updates` script.

- `YUP_ID`

Paste the contents of the `/etc/zmd/deviceid` file into this variable.

- `YUP_PASS`

Paste the contents of the `/etc/zmd/secret` file into this variable.

- `YUP_ARCH`

Set this variable to `x86_64`.

- YUP_SUBVERSIONS

Set this variable to SP2.

2. Create the `yup` directory referenced above with the following command:

```
# mkdir /var/spool/yup-updates
```

The `yup` command downloads packages to the `/var/spool/yup-updates` directory. The `sync-repo-updates` script moves the SLES packages from that directory into the `/tftpboot/distro/sles-10-x86_64` directory so that the local SLES package repository on the admin node contains the updated packages.

3. Execute the `/opt/sgi/sbin/sync-repo-updates` script or run `yup` manually.

The `sync-repo-updates` script should now be able to download SLES updates directly from the update server of Novell and update the local SLES package repository on the admin node so that you can use the `yum` command to install or update SLES packages throughout the node.

Note: The variables in `/etc/sysconfig/yup` are important because by default you will only have access to the SLES updates for `x86_64` by default. Setting `YUP_ARCH` or `YUP_SUBVERSIONS` variables incorrectly can lead to `403/permission denied` errors. The `yup` may also error out when accessing SLES10-SP2-Online files; it is safe to ignore that error.

Update the RHEL Package Repository

As described in "Update the SGI Package Repositories on the Admin Node" on page 110, it is possible to download packages updates from Red Hat and apply those updates across the cluster. To download updates from Red Hat, you need to register the admin node with Red Hat Network (RHN). To do this, you can run the `rhn_register` command. Enter your Red Hat Network account information when prompted. After you are registered, you are able to download the Red Hat updates using the `sgi sync-repo-updates-tool` (described later).



Warning: SGI disables the RHN plugin by default. This is very important because, if the RHN plugin is enabled on the admin node, most distro related packages will be downloaded from Red Hat instead of the admin node itself when creating an image. This would lead to image creation times taking a very long time, depending on your connection to the outside world. Therefore, SGI disables RHN and only enables it when we need to sync (described later).

After you are registered with RHN, you may use the Red Hat updates feature of the `/opt/sgi/sbin/sync-repo-updates` script. The script will do the following Red Hat specific tasks (after it has download SGI updates from SGI servers):

- Temporarily enable the RHN plugin.
- Use the `reposync` command to download the updates from Red Hat, dumping them in to a staging area.
- Disable the RHN plugin.
- Copy the packages in to the Red Hat distro repository, `/tftpboot/distro/RHEL5.2`.
- Update the `yum` metadata so that the newer packages are available to the cluster for installation with the `cinstallman` tool.

SGI has observed that the RHN sync process will sometimes not complete the first couple times it has run. SGI has seen temporary connection failures. In that case, just re-start the `sync-repo-updates` script to re-try. The problem will likely only be seen when you are doing the first giant sync of all updates as subsequent runs of the command will only download what is new.

Installing Updates on Running Admin, Leader, and Service Nodes

This section explains how to update existing nodes and images to the latest packages in the repositories.

To install updates on the admin node, perform the following command from the admin node:

```
admin:~ # cinstallman --update-node --node admin
```

To install updates on all online leader nodes, perform the following command from the admin node:

```
admin:~ # cinstallman --update-node --node r\*lead
```

To install updates on all managed and online service nodes, perform the following from the admin node:

```
admin:~ # cinstallman --update-node --node service\*
```

To install updates on the admin, all online leader nodes, and all online and managed service nodes with one command, perform the following command from the admin node:

```
admin:~ # cinstallman --update-node --node \*
```

Please note the following:

- The `cinstallman` command does not operate on running compute nodes.
- When using a node aggregation, for example, the asterisk (*), if a node happens to be unreachable, it is skipped. Therefore, you should ensure that all expected nodes get their updated packages.
- For more information on the `crepo` and `cinstallman` commands, see "crepo Command" on page 129 and "cinstallman Command" on page 131, respectively.

Updating Packages Within Systemimager Images

You can also use the `cinstallman` command to update `systemimager` images with the latest software packages.

Note: Changes to the kernel package inside the compute image require some additional steps before the new kernel can be used on compute nodes (see "Additional Steps for Compute Image Kernel Updates" on page 116 for more details). This note does **not** apply to leader or managed service nodes. Replace `sles10sp2` with the distro and version you are using.

The following examples show how to upgrade the packages inside the three node images supplied by SGI:

```
admin:~ # cinstallman --update-image --image lead-sles10sp2
admin:~ # cinstallman --update-image --image service-sles10sp2
```

```
admin:~ # cinstallman --update-image --image compute-sles10sp2
```

Note: Changes to the compute image on the admin node are not seen by the compute nodes until the updates have been pushed to the leader nodes with the `cimage` command. Updating leader and managed service node images ensure that the next time you add or re-discover or re-image a leader or service node, it will already contain the updated packages.

Before pushing the compute image to the leaders using the `cimage` command, it is good idea to clean the `yum` cache.

Note: The `yum` cache can grow and is in the writable portion of the compute blade image. This means it is replicated 64 times per compute blade image per rack and the space that may be used by compute blades is limited by design to minimize network and load issues on rack leader nodes.

To clean the `yum` cache, from the system admin controller (admin node), perform the following:

```
# cinstallman --yum-image --image compute-sles10sp2 clean all
```

Additional Steps for Compute Image Kernel Updates

Any time a compute image is updated with a new kernel, you will need to run some additional steps in order to make the new kernel available. The following example assumes that the compute node image name is `compute-sles10sp2` and that you have already updated the compute node image in the image directory per the instructions in "Creating Compute and Service Node Images Using the `cinstallman` Command" on page 146. If you have named your compute node image something other than `compute-sles10sp2`, replace this in the example that follows:

1. Shut down any compute nodes that are running the `compute-sles10sp2` image (see "Power Management Commands" on page 154).
2. Push out the changes with the `cimage --push-rack` command, as follows:

```
# cimage --push-rack compute-sles10sp2 r\*
```

3. Update the database to reflect the new kernel in the `compute-sles10sp2`, as follows:

```
# cimage --update-db compute-sles10sp2
```

4. Verify the available kernel versions and select one to associate with the `compute-sles10sp2` image, as follows:

```
# cimage --list-images
```

5. Associate the compute nodes with the new kernel/image pairing, as follows:

```
# cimage --set compute-sles10sp2 2.6.16.46-0.12-smp "r*i*n*"
```

Note: Replace `2.6.16.46-0.12-smp` with the actual kernel version.

6. Reboot the compute nodes with the new kernel/image.

Upgrading from SGI ProPack 6 SP1 to SGI ProPack 6 SP2

For information on upgrading your system from SGI ProPack 6 for Linux Service Pack 1 to SGI ProPack 6 for Linux Service Pack 2, see the release notes. The SGI ProPack 6 SP2 release notes can be found in a file named `README.TXT` that is available in `/docs` directory on the SGI ProPack 6 for Linux Service Pack 2 CD.

The SGI ProPack 6 for Linux Service Pack 2 release notes get installed to the following location on a system running SGI ProPack 6 SP2:

```
/usr/share/doc/packages/sgi-propack-6/README.txt
```

Cascading Dual-Boot

This section describes cascading dual-root (multiple root) support. This adds the notion of a "root slot" that represents a `/` (root directory) and `/boot` directory pair for a certain operating system. The layout and usage is described in the section that follows.

Partition Layout for Admin, Leader, and Service Nodes with Multiroot

For the the Tempo v1.6 release, only leader node have XFS root filesystems. Partition layout for more than one slot is shown in Table 2-1 on page 118.

Table 2-1 Partition Layout for Multiroot

Partition	Filesystem Type	Filesystem Label	Notes
1	swap	sgiswap	Partition Layout: Multiroot
2	ext3	sgidata	SGI Data Partition, MBR boot loader for admin nodes
3	extended	N/A	Extendedpartition, making logicals out of the rest of the disk
5	ext3	sgiboot	/boot partition for slot 1
6	ext3 or xfs	sgiroot	/partition for slot 1
7	ext3	sgiboot	/boot partition for slot 2 (optional)
8	ext3 or xfs	sgiboot	/ partition for slot 2

Table 2-1 on page 118 shows a partition table with two available slots. Tempo supports up to five available slots. After five slots, partitions are not available to support the slot.

Partition Layout for a Single Root

Partition layout for a single root is shown in Table 2-2 on page 119. Partition layout for single slot is the same layout that leader and service nodes have used previously. Legacy leader/service node layout is used for single slot, in order to generate the correct pxelinux chainload setup. Previously, the MBR bootloader was used. For multiroot, a chainload to a root slot boot partition is used.

Table 2-2 Partition Layout for Single Root

Partition	Filesystem Type	Filesystem Label	Notes
1	ext3	sgiboot	/boot
2	extended	n/a	Extended partition, making logicals out of the rest of the disk
5	swap	sgiswap	Swap partition
6	ext3 or xfs	sgiroot	/

Prior to 1.6 release, admin nodes had a different partition layout than either shown in Table 2-1 on page 118 or Table 2-2 on page 119. It had two partitions: swap and a single root. No separate /boot. Any newly installed admin node will have one of the two partition layouts described in the tables above. However, since admin nodes can be upgraded as opposed to re-installed, you may have one of three different partition layouts for admin nodes.

Admin Node Installation Choices Related to Cascading Dual-Boot

When you boot the admin node installation DVD, you are brought to a `syslinux` boot banner by default with a boot prompt, as in previous releases.

The multiroot feature support adds a few new parameters, as follows:

- `re_partition_with_slots`

When installing, re-partition the admin node to allow for the specified number of slots, default is 2.

- `install_slot`

Details which root slot to install to for this session, a number from 1 to the number of slots available, default

- `destructive`

If `destructive` is set to 1, potentially destructive operations are allowed. Some examples follow.

If an admin node is encountered with exactly one blank/virgin disk, and no parameters are provided, the admin node will be configured with a partition table for two slots and will install an operating system in to the first slot.

If an admin node is encountered with more than one blank/virgin disk, a protection mechanism triggers and the installer errors out because we are not sure which disk to choose.

If an admin node is encountered with a disk previously used for Tempo use, nothing destructive will happen unless the `destructive=1` parameter is passed.

If an `install_slot` is specified that appears to have been used for something once, it will not be reformatted unless `destructive=1` is supplied.

Note: This detection is simply parted detecting what filesystem was there. If you subsequently re-partitioned your disk using the same partition layout, then partitions from the past may appear to parted as having a valid filesystem when you might not expect that. In this case, just use `destructive=1` once you confirm it is okay to proceed.

If `re_partition_with_slots` is supplied, and a previous Tempo configuration is detected, it will error out unless `destructive=1` is supplied.

Leader and Service Node Installation

Leader and service nodes are installed, as previously. However, they mimic the admin node in terms of partition layout and which slot is used for what purpose.

Therefore, when a `discover` operation is performed, the slot used for installation is the same slot on which the admin node is currently booted. So you cannot choose what goes where, currently, it all matches the admin node.

If the leader or service node is found to have a slot count that does not match the admin node, the node is re-partitioned. It is assumed if the admin node changes its layout, all partitions on leaders and service nodes are re-initialized as well.

Choosing a Slot to Boot the Admin Node

After the admin node is installed with Tempo 1.6 (or later), it will boot one of two ways. If only one root slot is configured, the MBR of the admin node will be used to boot the root as usual.

However, if more than one root slot is selected, then the grub loader in the MBR will direct you to a special grub menu that allows you to choose a root slot.

For the multi-root admin node, the `sgidata` partition is used to store some grub files and grub configuration information. Included is a chainload for each slot. Therefore, the first grub to come up on the admin node chooses between a list of slots. When a slot is selected, a chainload is performed and the grub representing that slot comes up.

How to Handle Resets, Power Cycles, and BMC dhcp Leases When Changing Slots

This section describes how to handle resets, power cycles, and BMC dhcp leases when changing slots, as follows:

- Prior to rebooting the admin node to a new root slot, you should shut down the entire cluster including compute blades, leader nodes, and service nodes. If you use the `cpower` with the `--shutdown` option, the managed leader and service nodes will be left in a single user mode state. An example `cpower` command is, as follows:

```
admin:~ # cpower --shutdown --system
```

- After this is complete, reboot the admin node and boot the new slot.
- After the admin node comes up on its new slot, you should use the `cpower` command to reboot all of the leader and service nodes. This ensures that they reboot and become available. An example `cpower` command is, as follows:

```
admin:~ # cpower --reboot --system
```

Note: In some cases, the IP address setup in one slot may be different than another. This problem can potentially affect leader and service node BMCs. After the admin node is booted up in to a new slot, it is possible the BMCs on the leaders and service nodes may have hung on to their old IP addresses. They will eventually time-out and grab new leases. This problem may manifest itself in `cpower` not being able to communication with the BMCs properly. If you have trouble connecting to leader and service node BMCs after switching slots on the admin node, give the nodes up to 15 minutes to grab a new leases that match the new slot.

Leader and Service Node Booting

The way leader and service nodes boot is dependent on whether the cascading dual-boot feature is in use or not, as explained in this section.

Leader and Service Node Booting on a System Configured with One Root Slot

When a system is configured with only one root slot, it is not using the cascading dual-boot feature. This may be because you want all the disk space on your nodes dedicated to a single installation, or it may be because you have upgraded from previous Tempo releases that did not make use of this feature and you do not want to reinstall at this time.

When not using the cascading dual-boot feature, the admin node creates PXE configuration files that direct the service and leader nodes to do one of the following:

- Boot from their disk
- Boot over the network to reinstall themselves; if set up to re-image themselves by the `cinstallman` command (see "cinstallman Command" on page 131) or by initial discovery with the `discover` command (see "discover Command" on page 68).

Leader and Service Node Booting on a System Configured with Multiple Roots Slots

When a system is configured with two or more root slots, it is using the cascading dual-boot feature.

In this case, the admin node creates leader and service PXE configuration files that direct the managed service and leader nodes to do one of the following:

- Boot from the currently configured slot
- Reinstall the currently configured slot

Which slot is current, is determined by the slot on which the admin node is booted. Therefore, the admin node and all managed service and leader nodes are always booted on the same slot number.

In order to configure a managed service or leader node to boot from a given slot, the admin node creates a PXE configuration file that is configured to load a chainloader. This chainloader is used to boot the appropriate boot partition of the managed service or leader node.

This means that, in a cascading dual-boot situation, the service and leader nodes do not have anything in their master boot record (MBR). However, each `/boot` has `grub` configured to match the associated root slot. A `syslinux` chainload is performed by PXE to start `grub` on the appropriate boot partition.

If, for some reason, a PXE boot fails to work properly, there will be no output at all from that node. This means that cascading dual-boot is heavily dependent on PXE boots working properly for its operation.

Note: Unlike the managed service and leader nodes, the admin node always has an MBR entry. See "Choosing a Slot to Boot the Admin Node" on page 121.

Slot Cloning

A script named `/opt/sgi/sbin/clone-slot` is available. This script allows you to clone a source slot to a destination slot. It then handles synchronizing the data and fixing up `grub` and `fstabs` to make the cloned slot a viable booting choice.

The script sanitizes the input values, then calls a worker script in parallel on all managed nodes and the admin node that does the actual work. The `clone-slot` script waits for all children to complete before exiting.

Important: If the slot you are using as a source is the mounted/active slot, the script will shut down `mysql` on the admin node prior to starting the backup operation and start it when the backup is complete. This ensures there is no data loss.

Admin Node: Managing Which Slot Boots by Default

Use the `cadmin` command to control which slot on the admin node boots by default.

To show the slot that is currently the default, perform the following:

```
# cadmin --show-default-root
```

To change it so slot 2 boots by default, perform the following:

```
# cadmin --set-default-root --slot 2
```

Admin Node: Managing Grub Labels

You can use the `cadmin` command to control the `grub` labels the various slots have. When a slot is installed, the label is updated to be in this form:

```
slot 1: tempo 1.6 / rhel5.2: (none)
```

You can adjust the last part (none in the above example). The following are some example commands.

Show the currently configured `grub` root labels, as follows:

```
# cadmin --show-root-labels
```

Set the customer-adjustable portion of the root label for slot 1 to say "life is good", as follows:

```
# cadmin --show-root-labels
slot 1: tempo 1.6 / rhel5.2: first rhel
slot 2: tempo 1.6 / rhel5.2: my party
slot 3: tempo 1.6 / sles102: I can cry if I want to.
slot 4
# cadmin --set-root-label --slot 1 --label "life is good"
# cadmin --show-root-labels
slot 1: tempo 1.6 / rhel5.2: life is good
slot 2: tempo 1.6 / rhel5.2: my party
slot 3: tempo 1.6 / sles10sp2: I can cry if I want to.
slot 4
```

Admin Node: Which root slot is in use?

You can use the `cadmin` command to show the root slot you are currently booted in to on the admin node, as follows:

```
# cadmin --show-current-root  
admin node currently booted on slot: 2
```

System Operation

This chapter describes how to use the SGI Tempo systems management software to operate your Altix ICE system and covers the following topics:

- "Software Image Management" on page 127
- "Power Management Commands" on page 154
- "C3 Commands" on page 160
- "cadmin: SGI Tempo Administrative Interface" on page 165
- "Console Management" on page 168
- "Keeping System Time Synchronized" on page 170
- "Disabling Swap Space" on page 173
- "Changing the Size of Per-node Swap Space" on page 174
- "Switching Compute Nodes to a `tmpfs` Root" on page 175
- "Changing the Size of `/tmp` on Compute Nodes" on page 172
- "RAID Utility" on page 178
- "Backing up and Restoring the System Database" on page 181

Software Image Management

This section describes image management operations.

This section describes SLES10 services turned off on compute nodes by default, how you can customize the software running on compute nodes or service nodes, create a simple clone image of compute node or service node software, how to use the `cimage` command, how to use `crepo` command to manage software image repositories, and how to use the `cinstallman` command to create compute and service node images. It covers these topics:

- "Compute Node Services Turned Off by Default" on page 128
- "crepo Command" on page 129

- "cinstallman Command" on page 131
- "Customizing Software On Your SGI Altix ICE System" on page 134
- "cimage Command" on page 141
- "Using cinstallman to Install Packages into Software Images" on page 145
- "Using yum to Install Packages on Running Service or Leader Nodes" on page 146
- "Creating Compute and Service Node Images Using the cinstallman Command" on page 146
- "Installing a Service Node with a Non-default Image" on page 148
- "Using a Custom Repository for Site Packages" on page 149
- "SGI Altix ICE System Configuration Framework" on page 149
- "Cluster Configuration Repository: Updates on Demand" on page 152

Compute Node Services Turned Off by Default

To improve the performance of applications running MPI jobs on compute nodes, most services are disabled by default in compute node images. To see what adjustments are being made, view the `/etc/opt/sgi/conf.d/80-compute-distro-services` script.

If you wish to change anything in this script, SGI suggests that you copy the existing script to `.local` and adjust it there. Perform the following commands:

```
# cd /var/lib/systemimager/images/compute-image-name
# cp etc/opt/sgi/conf.d/80-compute-distro-services 80-compute-distro-services.local
# vi etc/opt/sgi/conf.d/80-compute-distro-services.local
```

At this point, the configuration framework will execute the `.local` version, and skip the other. For more information on making adjustments to configuration framework files, see "SGI Altix ICE System Configuration Framework" on page 149.

Use the `cimage` command to push the changed image out to the leader nodes.

crepo Command

You can use the `crepo` command to manage software repositories, such as, SGI Foundation, SGI Tempo, SGI ProPack, and SLES10 SP2. You also use the `crepo` command to manage any custom repositories you create yourself.

The `configure-cluster` command calls the `crepo` command when it prompts you for media and then makes it available. You can also use the `crepo` command to add additional media.

For the Tempo v1.5 release, the repositories are, as follows:

Repository	Description
<code>/tftpboot/sgi/*</code>	For SGI media
<code>/tftpboot/other/*</code>	For any YaST-style media that is not from SGI
<code>/tftpboot/distro/*</code>	For Linux distribution repositories such as SLES or RHEL
<code>/tftpboot/x</code>	Customer-supplied repositories

The directory and repository names are determined automatically for YaST or RHEL compatible media including media supplied by SGI and the Linux `distro` distributors. For customer repositories, the customer supplies a name when pointing at a directory full of RPMs that comprises the repository. You need to populate the directory before pointing the `crepo` command at it. The `crepo` command collects information about update sources and provides that for the `sync-repo-updates` command. Since any media product may have an independent update URL, the `crepo` command has an interface that provides information about all available repositories to commands like `installman`. This means you do not have to supply these URLs on the command line.

Additionally, the `crepo` command constructs default RPM lists based on the suggested packages on SGI media. For example, SGI ProPack may suggest certain packages be installed by default for service, compute, and leader nodes. The `crepo` command collects this information, along with suggested packages, from all other repositories, and uses it to generate new suggested RPM lists in

`/etc/opt/sgi/rpmlists`. The following example shows the contents of the `/etc/opt/sgi/rpmlists` directory after the `crepo` command has created the suggested RPM lists. The files with `-distro-` in the name are the base Linux distro RPMs that SGI recommends. The `compute-sles10sp2.rpm`, `lead-sles10sp2.rpm`, and `service-sles10sp2.rpm`, `compute-rhel52.rpm`, `lead-rhel52.rpm`, and `service-rhel52.rpm` files are the ones that `crepo` created based on the distro RPM lists in this directory plus any suggested packages from any media added with the `--add` operation.

Use the `ls` command to see a list of rpms, as follows:

```
/etc/opt/sgi/rpmlists # ls
compute-distro-rhel52.rpm      lead-sles10sp2.rpm
compute-distro-sles10sp2.rpm  service-distro-rhel52.rpm
compute-sles10sp2.rpm         service-distro-sles10sp2.rpm
lead-distro-rhel52.rpm        service-sles10sp2.rpm
lead-distro-sles10sp2.rpm
```

For a `crepo` command usage statement, perform the following:

```
system-admin:~ # crepo --h
crepo Usage:
Operations:
--help           : print his usage message

--add {path/URL} : add SGI/tempo media to the system repositories
  --custom {name}: Optional.Use with -add to add custom repo under
                  /tftpboot Repo must pre-exist for this case.

--del {product}  : delete an add-on product and associated /tftpboot repo

--show           : show available add-on products

--show-distro    : like show, but only reports distro media like sles10sp2

--show-updateurls : Show the update sources associated add-on products

--reexport       : re-export all repositories with yume. Use if there
                  was a yume export problem previously.

Flags:
```

Note for `--add`: If the pathname is local to the machine, it can be an ISO file or mounted media. If a network path is used `--` such as an nfs path or a URL `--` the path must point to an ISO file.

Use `--add` for SGI/tempo media, to make the repos and rpms available. If the supplied SGI/tempo media has suggested rpms from tempo node types, those suggested rpms will be integrated with the default rpmlists for leader, service, and compute nodes. You can use `create-default-sgi-images` to re-create the default images including new suggested packages or you can just browse the updated versions in `/etc/opt/sgi/rpmlists`.

Use `--add` with `--custom` to register your own custom repository. This will ensure that, by default, the custom repository is available to `yume` and `mksimage` commands. It is assumed you will maintain your own default package lists, perhaps using the sgi default package lists in `/etc/opt/sgi/rpmlists` as a starting point. The directory and rpms within must pre-exist. This script will create the yum metadata for it.

Example:

```
crepo --add /tftpboot/myrepo --custom my-custom-name
```

cinstallman Command

The `cinstallman` command is a wrapper tool for several Tempo operations that previously ran separately. You can use the `cinstallman` command to perform the following:

- Create an image from scratch
- Clone an existing image
- Recreate an image (so that any nodes associated with said image prior to the command are also associated after)
- Use existing images that may have been created by some other means
- Delete images
- Show available images
- Update or manage images (via `yume`)
- Update or manage nodes (via `yume`)

- Assign images to nodes
- Choose what a node should do next time it reboots (image itself or boot from its disk)

Starting with the SGI Tempo v1.4 release, you no longer need to use `yum`, `yume`, or `mksiimage` commands directly for most common operations. Compute images are automatically configured in such a way as to make them available to the `cimage` command.

For a `cinstallman` command usage statement, perform the following:

```
system-admin:~ # cinstallman --h
cinstallman Usage:
```

`cinstallman` is a tool that manages:

- image creation (as a wrapper to `mksiimage`)
- node package updates (as a wrapper to `yume`)
- image package updates (`yume` within a `chroot` to the image)

This is a convenience tool and not all operations for the commands that are wrapped are provided. The most common operations are collected here for ease of use.

For operations that take the `--node` parameter, the node can be an aggregation of nodes like `cimage` and `cpower` can take. Depending on the situation, non-managed or offline nodes are skipped.

The tool retrieves the registered repositories from `crepo` so that they need not be specified on the command line.

Operations:

```
--help           : print his usage message
--create-image   : create a new systemimager image
                  By default, requires --rpmlist and --image
                  Optional flags below:
--clone          : Clone existing image, requires --source, --image.
                  Doesn't require --rpmlist.
--recreate       : Like --del-image then --add-image, but preserves any
                  node associations.
                  Requires --image and --rpmlist
--use-existing   : register an already existing image, doesn't
```

```
require --rpmlist
--image {image} : Specify the image to operate on
--rpmlist {path} : Provide the rpmlist to use when creating images
--source {image} : Specify a source image to operate on (for clone)

--del-image      : delete the image, may use with --del-nodes
--image {image}  : Specify the image to operate on

--show-images    : List available images (similar to mksiimage -L)

--show-nodes     : Show non-compute nodes (similar to mksimachine -L)

--update-image   : update packages in image to latest packages available
                  : in repos, Requires --image
--image {image}  : Specify the image to operate on

--refresh-image  : Refresh the given image to include all packages
                  : in the supplied rpmlist. Use after registering
                  : new media with crepo that has new suggested rpms.
--image {image}  : Specify the node or nodes to operate on
--rpmlist {path} : rpmlist containing packages to be sure are included

--yum-image      : Perform yum operations to supplied image, via yume
                  : Requires --image, trailing arguments passed to yume
--image {image}  : Specify the image to operate on

--update-node    : Update supplied node to latest pkgs avail in
                  : repos, requires --node
--node {node}    : Specify the node or nodes to operate on

--refresh-node   : Refresh the given node to include all packages
                  : in the supplied rpmlist. Use after registering
                  : new media with crepo that has new suggested rpms.
--node {node}    : Specify the node or nodes to operate on
--rpmlist {path} : rpmlist containing packages to be sure are included

--yum-node       : Perform yum operations to nodes, via yume. Requires
                  : --node. Trailing arguments passed to yume
--node {node}    : Specify the node or nodes to operate on

--assign-image   : Assign image to node. Requires --node, --image
```

```
--node {node}      : Specify the node or nodes to operate on
--image {image}    : Specify the image to operate on

--next-boot {image|disk}: node action next boot: boot from disk or
                        reinstall/reimage? Requires --node
```

In the following example, the `--refresh-node` operation is used to ensure the online managed service nodes include all the packages in the list. You could use this if you updated your `rpmlist` to include new packages or if you recently added new media with the `crepo` command and want running nodes to have the newly updated packages. A similar `--refresh-image` operation exists for images.

```
# cinstallman --refresh-node --node service\* --rpmlist
/etc/opt/sgi/rpmlists/service-sles10sp2.rpmlist
```

Customizing Software On Your SGI Altix ICE System

This section discusses how to manage various nodes on your SGI Altix ICE system. It describes how to configure the various nodes, including the compute and service nodes. It describe how to augment software packages. Many tasks having to do with package management have multiple valid methods to use.

For information on installing patches and updates, see "Installing SGI Tempo Patches and Updating SGI Altix ICE Systems " on page 109.

Creating Compute Node Custom Images

You can add per-host compute node customization to the compute node images. You do this by adding scripts either to the `/opt/sgi/share/per-host-customization/global/` directory or the `/opt/sgi/share/per-host-customization/mynewimage/` directory on the system admin controller.

Note: When creating custom images for compute nodes, make sure you clone the original SGI images. This provides the original images intact that you can fall back to if necessary. The folowing example is based on SLES.

Scripts in the global directory apply to all compute nodes images. Scripts under the image name apply only to the image in question. The scripts are cycled through once

per host when being installed on the rack leader controllers. They receive one input argument, which is the full path (on the rack leader controller) to the per-host base directory, for example, `/var/lib/sgi/mynewimage/i2n11`. There is a README file at `/opt/sgi/share/per-host-customization/README` on the system admin controller, as follows:

This directory contains compute node image customization scripts which are executed as part of the install-image operations on the leader nodes when pulling over a new compute node image.

After the image has been pulled over, and the per-host-customization dir has been rsynced, the per-host `/etc` and `/var` directories are populated, then the scripts in this directory are cycled through once per-host. This allows the scripts to source the node specific network and cluster management settings, and set node specific settings.

Scripts in the global directory are iterated through first, then if a directory exists that matches the image name, those scripts are iterated through next.

You can use the scripts in the global directory as examples.

An example global script,

`/opt/sgi/share/per-host-customization/global/sgi-hostname` is, as follows:

```
#!/bin/sh
# Copyright (c) 2007 Silicon Graphics, Inc.
# All rights reserved.
#
# Set the compute node's hostname to the cluster unique name
#
# This script is executed once per-host as part of the install-image operation
# run on the leader nodes, which is called from cimage on the admin node.
# The full path to the per-host iru+slot directory is passed in as $1,
# e.g. /var/lib/sgi/per-host//i2n11.
#
# sanity checks
. /opt/sgi/share/per-host-customization/global/sanity.sh

iruslot=$1
```

```
# source cluster management information
. ${iruslot}/etc/opt/sgi/cminfo

# set hostname of blade to cluster unique name
echo ${NAME} > ${iruslot}/etc/HOSTNAME
```

Compute Node Per-Host Customization for Additional Network Interfaces

Per compute-node customization may be useful for configuring additional network interfaces that are on some, but not all, compute nodes. An example of how to configure network interfaces on individual compute nodes is the `/opt/sgi/share/per-host-customization/mynewimage/mycustomization` script, that follows:

```
Copyright (c) 2008 Silicon Graphics, Inc.
# All rights reserved.
#
# do node specific setup
#
# This script is executed once per-host as part of the install-image operation
# run on the leader nodes, which is called from cimage on the admin node.
# The full path to the per-host iru+slot directory is passed in as $ARGV[0],
# e.g. /var/lib/sgi/per-host/<imagename>/i2n11.
#

use lib "/usr/lib/systemconfig", "/opt/sgi/share/per-host-customization/global";
use sanity;

sanity_checks();

$blade_path = $node = $ARGV[0];
$node =~ s/.*\///;

sub i0n4 {
    my $ifcfg="etc/sysconfig/network/ifcfg-eth2";
    open(IFCFG, ">$blade_path/$ifcfg") or
        die "$0: can't open $blade_path/$ifcfg";
    print IFCFG<<EOF
BOOTPROTO='static'
IPADDR='10.20.0.1'
```

```
NETMASK='255.255.0.0'  
STARTMODE='onboot'  
WIRELESS='no'  
EOF  
    ;  
    close(IFCFG);  
}  
  
@nodes = ("i0n4");  
  
foreach $n (@nodes) {  
    if ( $n eq $node ) {  
        eval $n;  
    }  
}
```

Pushing `mynewimage` to rack 1 causes the `eth2` interface of compute node `r1i0n4` to be configured with IP address `10.20.0.1` when the node is brought up with `mynewimage`. Push the image, as follows:

```
# cimage --push-rack mynewimage r1
```

Customizing Software Images

Note: Procedures in this section describe how to work with service node and compute node images. Always use a cloned image. If you are adjusting an RPM list, use your own copy of the RPM list.

The service and compute node images are created during the `configure-cluster` operation (or during your upgrade to SGI ProPack 5 SP3 if you were running SGI ProPack 5 SP2, previously). This process uses an RPM list to generate a root on the fly.

You can clone a compute node image, or create a new one based on an RPM list. For service nodes, SGI does not support a clone operation. For compute images, you can either clone the image and work on a copy or you can always make a new compute node image from the SGI supplied default RPM list.

Procedure 3-1 Clone a Compute Node Image

To clone a compute node image, perform the following steps:

1. From the system admin controller, create a clone of the compute node image, as follows:

```
# cinstallman --create-image --clone --source compute-sles10sp2 --image new
```

After that command is complete, you will have a new image located in `/var/lib/systemimager/images/new` on the system admin controller.

2. To see that the image is now available, perform the following command:

```
# cimage --list-images
image: compute-sles10sp2
kernel: 2.6.16.60-0.17-smp

image: new
kernel: 2.6.16.60-0.17-smp
```

For RPM lists, the default RPM lists are located under `/etc/opt/sgi/rpmlists`. The `rpmlist` names, such as, `service-distro-rhel52.rpmlist` and `compute-distro-les10sp2.rpmlist` are Linux distribution specific lists that have no supplied packages in them supplied by SGI. They are used to generate the full `rpmlists`. The full `rpmlists` consist of the `distro rpmlists` plus any packages recommended for installation by media registered with the `crepo` repository management tool. When default images are created by SGI, the `rpmlists` without the word "distro" in the name are used. For example, for SLES, the generated `rpmlists` would be `lead-sles10sp2.rpmlist`, `service-sles10sp2.rpmlist`, `compute-sles10sp2.rpmlist`. For RHEL, it is similar but with `rhel52` in the name.

Procedure 3-2 Manually Adding a Package to a Compute Node Image

To manually add a package to a compute node image, perform the steps:

Note: Use the `cinstallman` command to install packages into images when the package you are adding is in a repository. This example shows a quick way to manually add a package for compute nodes when you do **not** want the package to be in a custom repository. For information on the `cinstallman` command, see "cinstallman Command" on page 131.

1. Make a clone of the compute node image, as described in "Customizing Software Images" on page 137.
2. Determine what images and kernels you have available now, as follows:

```
# cimage --list-images
image: compute-sles10sp2
      kernel: 2.6.16.60-0.17-smp

image: compute-sles10sp2-new
      kernel: 2.6.16.60-0.17-smp
```

3. From the system admin controller, change directory to the images directory, as follows:

```
# cd /var/lib/systemimager/images/
```

4. From the system admin controller, copy the RPMs you wish to add, as follows, where `compute-sles10sp2-new` is your own compute node image, as follows:

```
# cp /tmp/newrpm.rpm compute-sles10sp2-new/tmp
```

5. The new RPMs now reside in `/tmp` directory in the image named `compute-sles10sp2-new`. To install them into your new compute node image, perform the following commands:

```
# chroot compute-sles10sp2-new bash
```

And then perform the following:

```
# rpm -Uvh /tmp/newrpm.rpm
```

At this point, the image has been updated with the RPM.

6. The image on the system admin controller is updated. However, you still need to push the changes out. Ensure there are no nodes currently using the image and then run this command:

```
# cimage --push-rack compute-sles10sp2-new r\*
```

This will push the updates to the rack lead controllers and the changes will be seen by the compute nodes the next time they start up. For information on how to ensure the image is associated with a given node, see the `cimage --set` command and the example in Procedure 3-3, page 140.

Procedure 3-3 Creating a Simple Compute Node Image Clone

Note: Always work from a clone image, see "Customizing Software Images" on page 137.

To create a simple compute node image clone from the system admin controller, perform the following steps:

1. To clone the compute node image, perform the following:

```
# cinstallman --create-image --clone --source compute-sles10sp2 --image compute-sles10sp2-new
```

2. To see the images and kernels in the list, perform the following:

```
# cimage --list-images
image: compute-sles10sp2
      kernel: 2.6.16.60-0.17-smp

image: compute-sles10sp2-new
      kernel: 2.6.16.60-0.17-smp
```

3. To change the compute nodes to use the cloned image/kernel pair, perform the following:

```
# cimage --set compute-sles10sp2-new 2.6.16.60-0.17-smp "r*i*n"
```

Procedure 3-4 Manually Adding a Package to the Service Node Image

To manually add a package to the service node image, perform the following steps:

Note: Use the `cinstallman` command to install packages into images when the package you are adding is in a repository. This example shows a quick way to manually add a package for compute nodes when you do **not** want the package to be in a custom repository. For information on the `cinstallman` command, see "cinstallman Command" on page 131.

1. Use the `cinstallman` command to create your own version of the service node image. See "cinstallman Command" on page 131.
2. Change directory to the `images` directory, as follows:

```
# cd /var/lib/systemimager/images/
```

- From the system admin controller, copy the RPMs you wish to add, as follows, where `my-service-image` is your own service node image:

```
# cp /tmp/newrpm.rpm my-service-image/tmp
```

- The new RPMs now reside in `/tmp` directory in the image named `my-service-image`. To install them into your new service node image, perform the following commands:

```
# chroot my-service-image bash
```

And then perform the following:

```
# rpm -Uvh /tmp/newrpm.rpm
```

At this point, the image has been updated with the RPM. Please note, that unlike compute node images, changes made to a service node image will not be seen by service nodes until they are reinstalled with the image. If you wish to install the package on running systems, you can copy the RPM to the running system and use the RPM from there.

cimage Command

The `cimage` command allows you to list, modify, and set software images on the compute nodes in your system.

For a help statement, perform the following command:

```
sys-admin:~ # cimage --help
```

```
cimage is a program for managing compute node root images in SGI Tempo.
```

```
Usage: cimage OPTION ...
```

Options

<code>--help</code>	Usage and help text.
<code>--debug</code>	Output additional debug information.
<code>--list-images</code>	List images and their kernels.
<code>--list-nodes NODE</code>	List node(s) and what they are set to.
<code>--set [OPTION] IMAGE KERNEL NODE</code>	Set node(s) to image and kernel.
<code>--nfs</code>	Use NFS roots (default).
<code>--tmpfs</code>	Use tmpfs roots.
<code>--set-default [OPTION] IMAGE KERNEL</code>	Set default image, kernel, rootfs type.
<code>--nfs</code>	Use NFS roots (default).

<code>--tmpfs</code>	Use tmpfs roots.
<code>--show-default</code>	Show default image, kernel, rootfs type.
<code>--add-db IMAGE</code>	Add image and its kernels to the db.
<code>--del-db IMAGE</code>	Delete image and its kernels from db.
<code>--update-db IMAGE</code>	Short-cut for <code>--del-db</code> , then <code>--add-db</code> .
<code>--push-rack [OPTIONS] IMAGE RACK</code>	Push or update image on rack(s).
<code>--force</code>	Bypass the booted nodes check, deletes.
<code>--update-only</code>	Skip files newer in dest, no delete.
<code>--quiet</code>	Turn off diagnostic information.
<code>--del-rack IMAGE RACK</code>	Delete an image from rack(s).
<code>--clone-image OIMAGE NIMAGE</code>	Clone an existing image to a new image.
<code>--del-image [OPTIONS] IMAGE</code>	Delete an existing image entirely.
<code>--quiet</code>	Turn off diagnostic information.

RACK arguments take the format 'rX'

NODE arguments take the format 'rXiYnZ'

ROOTFS argument can be either 'nfs' or 'tmpfs'

X, Y, Z can be single digits, a [start-end] range, or * for all matches.

EXAMPLES

Example 3-1 cimage Command Examples

The following examples walk you through some typical `cimage` command operations.

To list the available images and their associated kernels, perform the following:

```
# cimage --list-images
```

```
image: compute-sles10sp2
      kernel: 2.6.16.60-0.17-smp
```

To list the compute nodes in rack 1 and the image and kernel they are set to boot, perform the following:

```
# cimage --list-nodes r1
rli0n0: compute-sles10sp2 2.6.16.60-0.17-smp
rli0n1: compute-sles10sp2 2.6.16.60-0.17-smp
rli0n2: compute-sles10sp2 2.6.16.60-0.17-smp
rli0n3: compute-sles10sp2 2.6.16.60-0.17-smp
rli0n4: compute-sles10sp2 2.6.16.60-0.17-smp
```

```

rli0n5: compute-sles10sp2 2.6.16.60-0.17-smp
rli0n6: compute-sles10sp2 2.6.16.60-0.17-smp
rli0n7: compute-sles10sp2 2.6.16.60-0.17-smp
rli0n8: compute-sles10sp2 2.6.16.60-0.17-smp
[...snip...]

```

To set the `rli0n0` compute node to boot the `2.6.16.60-0.17-smp` kernel from the `compute-sles10sp2` image, perform the following :

```
# cimage --set compute-sles10sp2 2.6.16.60-0.17-smp rli0n0
```

To list the nodes in rack 1 to see the changes set in the example above, perform the following:

```

# cimage --list-nodes r1
rli0n0: compute-sles10sp2 2.6.16.60-0.17-smp
rli0n1: compute-sles10sp2 2.6.16.60-0.17-smp
rli0n2: compute-sles10sp2 2.6.16.60-0.17-smp
[...snip...]

```

To set all nodes in all racks to boot the `2.6.16.60-0.17-smp` kernel from the `compute-sles10sp2` image, perform the following:

```
# cimage --set compute-sles10sp2 2.6.16.60-0.17-smp r*i*n*
```

To set two ranges of nodes to boot the `2.6.16.60-0.17-smp` kernel, perform the following:

```
# cimage --set compute-sles10sp2 2.6.16.60-0.17-smp rli[0-2]n[5-6] rli[2-3]n[0-4]
```

To clone the `compute-sles10sp2` image to a new image (so that you can modify it) , perform the following:

```

# cinstallman --create-image --clone --source compute-sles10sp2 --image mynewimage
Cloning compute-sles10sp2 to mynewimage ... done

```

The clone process adds the image and its kernels to the database

To change to the cloned image created in the example, above, copy the needed rpms into the `/var/lib/systemimager/images/mynewimage/tmp` directory, use the

`chroot` command to enter the directory and then install the rpms, perform the following:

```
# cp *.rpm /var/lib/systemimager/images/mynewimage/tmp
# chroot /var/lib/systemimager/images/mynewimage/ bash
# rpm -Uvh /tmp/*.rpm
```

If you make changes to the kernels in the image, you need to refresh the kernel database entries for your image. To do this, perform the following:

```
# cimage --update-db mynewimage
```

If you did not make changes to the kernels in the cloned image created in the example above, you can omit this step.

To push new software images out to the compute blades in a rack or set of racks, perform the following:

```
# cimage --push-rack mynewimage r*
r1lead: install-image: mynewimage
r1lead: install-image: mynewimage done.
```

To list images in the database the kernels they contain, perform the following:

```
# cimage --list-images

image: compute-sles10sp2
      kernel: 2.6.16.60-0.7-carlsbad
      kernel: 2.6.16.60-0.7-smp

image: mynewimage
      kernel: 2.6.16.60-0.7-carlsbad
      kernel: 2.6.16.60-0.7-smp
```

To set some compute nodes to boot an image, perform the following:

```
# cimage --set mynewimage 2.6.16.60-0.7-smp r1i3n*
```

You need to reboot the compute nodes to run the new images.

Completely remove an image you no longer use, both from system admin controller and all compute nodes in all racks, perform the following:

```
# cimage --del-image mynewimage
r1lead: delete-image: mynewimage
```

```
rllead: delete-image: mynewimage done.
```

Using `cinstallman` to Install Packages into Software Images

The packages that make up SGI Tempo, SGI Foundation, SLES10 SP2, and any other media or custom repositories you have added reside in repositories. The `cinstallman` command looks up the list of all repositories and provides that list to the commands it calls out for its operation such as `yume`.

Note: Always work with copies of software images.

The `cinstallman` command can update packages within `systemimager` images. You may also use `cinstallman` to install a single package within an image.

However, `cinstallman` and the commands it calls only works with the configured repositories. So if you are installing your own RPM, you will need that package to be part of an existing repository. You may use the `crepo` command to create a custom repository into which you can collect custom packages.

The following example shows how to install the `zlib-devel` package in to the service node image so that the next time you image or install a service node, it will have this new package.

```
# cinstallman --yum-image --image my-service-sles10sp2 install zlib-devel
```

You can perform a similar operation for compute node images. Note the following:

- If you update a compute node image on the system admin controller (admin node), you have to use the `cimage` command to push the changes. For more information on the `cimage` command, see "cimage Command" on page 141.
- If you update a service node image on the admin node, that service node needs to be reinstalled and/or reimaged to get the change. The `discover` command can be given an alternate image or you may use the `cinstallman --assign-image` command followed by the `cinstallman --next-boot` command to direct the service node to reimage itself with a specified image the next time it boots.

Using yum to Install Packages on Running Service or Leader Nodes

Note: These instructions only apply to managed service nodes and leader nodes. They do not apply to compute nodes.

You can use the `yum` command to install a package on a service node. From the admin node, you can issue a command similar to the following:

```
# cinstallman --yum-node --node service0 install zlib-devel
```

Note: To get all service nodes, replace `service0` with `service*`.

For more information on the `cinstallman` command, see "cinstallman Command" on page 131.

Creating Compute and Service Node Images Using the cinstallman Command

You can create service node and compute node images using the `cinstallman` command. This generates a root directory for images, automatically.

Fresh installations of SGI Tempo create these images during the `configure-cluster` installation step (see "Installing Software on the System Admin Controller").

The RPM lists that drive which packages get installed in the images are listed in files located in `/etc/opt/sgi/rpmlists`. For example, `/etc/opt/sgi/rpmlists/compute-sles10sp2.rpmlist` (see "crepo Command" on page 129). You should **NOT** edit the default lists. These default files are recreated by the `crepo` command when repositories are added or removed. Therefore, you should only use the default RPM lists as a model for your own.

Note: The procedure below uses SLES. Change, as necessary, for RHEL installations.

Procedure 3-5 Using the `cinstallman` Command to Create a Service Node Image:

To create a service node image using the `cinstallman` command, perform the following steps:

1. Make a copy of the example service node image RPM list and work on the copy, as follows:

```
# cp /etc/opt/sgi/rpmlists/service-sles10sp2.rpmlist
/etc/opt/sgi/rpmlists/my-service-node.rpmlist
```

2. Add or remove any packages from the RPM list. Keep in mind that needed dependencies are pulled in automatically.
3. Use the `cinstallman` command with the `--create-image` option to create the images root directory, as follows:

```
# cinstallman --create-image --image my-service-node-image --rpmlist
/etc/opt/sgi/rpmlists/my-service-node.rpmlist
```

This example uses `my-service-node-image` as the home/name of the image.

This command may take a long time and has a large amount of output. The output is automatically directed to a temporary file which you can review and delete as you wish. The command gives you the location of the output file when it runs.

4. After the `cinstallman` command finishes, the image is ready to be used with service nodes. You can supply this image as an optional image name to the `discover` command, or you may assign an existing service node to this image using the `cinstallman --assign-image` command. You can tell a service node to image itself next reboot by using the `cinstallman --next-boot` option.

Procedure 3-6 Use the `cinstallman` Command to Create a Compute Node Image

To create a compute node image using the `cinstallman` command, perform the following steps:

1. Make a copy of the compute node image RPM list and work on the copy, as follows:

```
# cp /etc/opt/sgi/rpmlists/compute-sles10sp2.rpmlist
/etc/opt/sgi/rpmlists/my-compute-node.rpmlist
```

2. Add or remove any packages from the RPM list. Keep in mind that needed dependencies are pulled in automatically.

3. Run the `cinstallman` command to create the root, as follows:

```
# cinstallman --create-image --image my-compute-node-image --rpmfile  
/etc/opt/sgi/rpmlists/my-compute-node.rpmfile
```

This example uses the name `my-compute-node-image` as the name.

This command may take a long time and has a large amount of output. The output is automatically directed to a temporary file which you can review and delete as you wish. The command gives you the location of the output file when it runs.

The `cinstallman` command makes the new image available to the `cimage` command.

4. For information on how to use the `cimage` command to push this new image to rack leader controllers (leader nodes), see "cimage Command" on page 141.

Installing a Service Node with a Non-default Image

If you have a non-default service node image you wish to install on a service node, you have two choices, as follows:

- Specify the image name when you first discover the node with the `discover` command.
- Use the `cinstallman` command to associate an image with a service node, then set up the node to reinstall itself the next time it boots.

The following example shows how to associate a custom image at discover time:

```
# discover --service 2,image=my-service-node-image
```

The next example shows how to reinstall an already discovered service node with a new image:

```
# cinstallman --assign-image --node service2 --image my-service-node-image  
# cinstallman --next-boot image --node service2
```

When you reboot the node, it will reinstall itself.

For more information on the `discover` command, see "discover Command" on page 68. For more information on the `cinstallman` command, see "cinstallman Command" on page 131.

Using a Custom Repository for Site Packages

This section describes how to maintain packages specific to your site and have them available to the `crepo` command (see "crepo Command" on page 129).

SGI suggests putting site-specific packages in a separate location. They should not reside in the same location as SGI or Novell supplied packages.

Procedure 3-7 Setting Up a Custom Repository for Site Packages

To set up a custom repository for your custom packages, perform the following steps:

1. Create directory for your site-specific packages on the system admin controller (admin node), as follows:

```
# mkdir -p /tftpboot/site-local/sles-10-x86_64
```

2. Copy your site packages in to the new directory, as follows:

```
# cp my-package-1.0.x86_64.rpm /tftpboot/site-local/sles-10-x86_64
```

3. Register your custom repository using the `crepo` command. This command will ensure your repository is consulted when the `cinstallman` command performs its operations. This command also creates the necessary `yum/repomd` metadata.

```
# crepo --add /tftpboot/site-local/sles-10-x86_64 --custom my-repo
```

Your new repository will automatically be consulted by `cinstallman` command operations going forward including updating images, nodes, and creating images.

4. If you use `cinstallman` to create an image, you will want to add your custom package to the `rpmlist` you use with the `cinstallman` command (see "Using `cinstallman` to Install Packages into Software Images" on page 145).

SGI Altix ICE System Configuration Framework

All node types that are part of an SGI Altix ICE system can have configuration settings adjusted by the configuration framework. There is some overlap between the per-host customization instructions and the configuration framework instructions. Each approach plays a role in configuring your system. The major differences between the two methods are, as follows:

- Per-host customization runs at the time an image is pushed to the rack leader controllers.

- Per-host customization only applies to compute node images.
- The Altix ICE system configuration framework can be used with all node types.
- The system configuration framework is run when a new root is created, when `SuSEconfig` command is run for some other reason, as part of a `yum` operation, or when new compute images are pushed with the `cimage` command.

This framework exists to make it easy to adjust configuration items. There are SGI-supplied scripts already present. You can add more scripts as you wish. You can also exclude scripts from running without purging the script if you decide a certain script should not be run. The following set of questions in bold and bulleted answers describes how to use the system configuration framework.

How does the system configuration framework operate?

These files could be added, for example, to a running service node, or to an already created service or compute image. Remember that images destined for compute nodes need to be pushed with the `cimage` command after being altered. For more information, see "cimage Command" on page 141.

- A `/opt/sgi/lib/cluster-configuration` script is called, from where it is called is described below.
- That script iterates through scripts residing in `/etc/opt/sgi/conf.d`.
- Any scripts listed in `/etc/opt/sgi/conf.d/exclude` are skipped, as are scripts, that are not executable.
- Scripts in system configuration framework **must** be tolerant of files that do not exist yet, as described below. For example, check that a `syslog` configuration file exists before trying to adjust it.
- Scripts ending in a distro name, or a distro name with a specific distro version are only run if the node in question is running that distro. For example, `/etc/opt/sgi/conf.d/99-foo.sles` would only run if the node was running `sles`. And `/etc/opt/sgi/conf.d/bar.rhel5` would only run if the node is running `rhel5`. This example shows the precedence of operations: If you had `88-myscript.sles10`, `88-myscript.sles`, and `88-myscript`
 - On a `sles10` system, `88-myscript.sles10` would execute
 - On a `sles` system that is not `sles10`, `88-myscript.sles` would execute
 - On all other distros, `88-myscript` would execute

- If you wish to make a custom version of a script supplied by SGI, you may simply name it with ".local" and the local version will run in place of the one supplied by SGI. This allows for customization without modifying scripts supplied by SGI. Scripts ending in .local have the highest precedence. In other words, if you had `88-myscript.rhel5`, `88-myscript.sles`, and `88-myscript.local`, then `88-myscript.local` would execute in all cases and the other `88-myscript` scripts would never execute.

From where is the framework called?

- The callout for `/opt/sgi/lib/cluster-configuration` is implemented as a yum plugin that executes after packages have been installed and cleaned.
- There is also a SUSE configuration script in `/sbin/conf.d`, called `SuSEconfig.00cluster-configuration`, that calls the framework. This is in case of you are using YaST to install or upgrade packages.
- One of the scripts called by the framework calls `SuSEconfig`. A check is made to avoid a callout loop.
- The framework is also called when the admin, leader, or service nodes start up. The call is made just after networking is configured. As a site administrator, you could create custom scripts here that check on or perform certain configuration operations.
- When using the `cimage` command to push a compute node root image to rack leaders, the configuration framework executes within the `chroot` of the compute node image after it is pulled from the admin node to the rack leader node.

How do I adjust my system configuration?

- Create a small script in `/etc/opt/sgi/conf.d` to do the adjustment.

Be sure that you test for existence of files and do not assume they are there (see "Why do scripts need to tolerate files that do not exist but should?" below).

Why do scripts need to tolerate files that do not exist but should?

- This is because the `mksiimage` command runs `yume` and `yum` in two steps. The first step only installs 40 or so RPMs but our framework is called then too. The second pass installs the other "hundreds" of RPMs. So the framework is called once before many packages are installed, and again after everything is in place. So not all files you expect might be available when your small script is called.

How does the yum plugin work?

- In order for the `yum` plugin to work, the `/etc/yum.conf` file has to have `plugins=1` set in its configuration file. SGI Tempo software ensures that is in place by way of a trigger in the `sgi-cluster` package. Any time `yum` is installed or updated, it verify `plugins=1` is set.

How does yume work?

- `yume`, an oscar wrapper for `yum`, works by creating a temporary `yum` configuration file in `/tmp` and then points `yum` at it. This temporary configuration file needs to have plugins enabled. A tiny patch to `yume` makes this happen. This fixes it for `yume` and also `mksiimage`, which calls `yume` as part of its operation.

Cluster Configuration Repository: Updates on Demand

The SGI Tempo 1.3 release included a new cluster configuration repository/update framework. This framework generates and distributes configuration updates to admin, service, and leader nodes in the cluster. Some of the configuration files managed by this framework include C3 conserver, DNS, Ganglia, hosts files, and NTP.

When an event occurs that requires these files to be updated, the framework executes on the admin node. The admin node stores the updated configuration framework in a special cached location and updates the appropriate nodes with their new configuration files.

In addition to the updates happening as required, the configuration file repository is consulted when a admin, service, or leader node boots. This happens shortly after networking is started. Any configuration files that are new or updated are transferred at this early stage so that the node is fully configured by the time the node is fully operational.

There are no hooks for customer configuration in the configuration repository at this time.

This update framework is tied in with the `/etc/opt/sgi/conf.d` configuration framework to provide a full configuration solution. As mentioned earlier, customers are encouraged to create `/etc/opt/sgi/conf.d` scripts to do cluster configuration.

cnodes Command

The `cnodes` command provides information about the types of nodes in your system. For help information, perform the following:

```
[sys-admin ~]# cnodes --help
Options:
  --all                all compute, leader and service nodes, and switches
  --compute           all compute nodes
  --leader            all leader nodes
  --service           all service nodes
  --switch            all switch nodes
  --online            modifier: nodes marked online
  --offline           modifier: nodes marked offline
  --managed           modifier: managed nodes
  --unmanaged         modifier: unmanaged nodes
  --temponames        modifier: return Tempo node names instead of hostnames
```

Note: default modifiers are 'online' and 'managed' unless otherwise specified.

EXAMPLES

Example 3-2 `cnodes` Example

The following examples walk you through some typical `cnodes` command operations.

To see a list of all nodes in your system, perform the following:

```
[sys-admin ~]# cnodes --all
rli0n0
rli0n1
rlllead
service0
```

To see a list of all compute nodes, perform the following:

```
[sys-admin ~]# cnodes --compute
rli0n0
rli0n1
```

To see a list of service nodes, perform the following:

```
[sys-admin ~]# cnodes --service
service0
```

Power Management Commands

The `cpower` command allows you to power up, power down, reset, and show the power status of system components.

`cpower` Command

The `cpower` command is, as follows:

```
cpower [<option> ...] [<target_type>] [<action>] <target>
```

The `<option>` argument can be one or more of the following:

Option	Description
<code>--noleader</code>	Do not include leader nodes (valid with rack and system domains only).
<code>--noservice</code>	Do not include service nodes (valid with system domain only).
<code>--force</code>	When using wildcards in the target, disable all “safety” checks. Make sure you really want to use this command.
<code>-n, --noexec</code>	Displays, but does not execute, commands that affect power.
<code>-v, --verbose</code>	Print additional information on command progress

Note: The command will fail if the target contains any wild cards, unless the `--all` option is specified.

The `<target>` argument is one of the following:

<code>--node</code>	Applies the action to nodes. Nodes are compute nodes, rack leader controllers (leader nodes), system admin controller (admin node), and service nodes. [default]
<code>--iru</code>	Applies the action at the IRU level.
<code>--rack</code>	Applies the action at the rack level.

`--system` Applies the action to the system. You must **not** specify a target with this type.

The `<action>` argument is one of the following:

`--status` Show the power status of the target, including whether it is booted or not. [default]

`--up` | `--on` Powers up the target.

`--down` | `--off` Powers down the target.

`--reset` Performs a hard reset on the target.

`--cycle` Power cycles the target.

`--boot` Boots up the target, unless it is already booted. Waits for all targets to boot.

`--reboot` Reboots the target, even if already booted. Wait for all targets to boot.

`--halt` Halts and then powers off the target.

`--shutdown` Shuts down the target, but does not power it off. Waits for targets to shut down.

`--identify` Turns on the identifying LED for the specified interval
`<interval>` in seconds. Uses an interval of 0 to turn off immediately.

`-h, --help` Shows help usage statement.

The target must always be specified except when the `--system` option is used. Wildcards may be used, but be careful **not** to accidentally power off or reboot the leader nodes. If wildcard use affects any leader node, the command fails with an error.

Operations on Nodes

The default for the `cpower` command is to operate on system nodes, such as compute nodes, leader nodes, or service nodes. If you do not specify `--iru`, `--rack`, or `--system`, the command defaulted to operating as if you had specified `--node`.

Here are examples of node target names:

- `r1i3n10`
Compute node at rack 1, IRU 3, slot 10

- `service0`
Service node 0
- `r3lead`
Rack leader controller (leader node) for rack 3
- `r1i*n*`
Wildcards let you specify ranges of nodes, for example, `r1i*n*` all compute nodes in all IRUs on rack 1

IPMI-style Commands

The default operation for the `cpower` command is to operate on nodes and to provide you the status of these nodes, as follows:

```
# cpower r1i*n*
```

This command is equivalent to the following:

```
# cpower --node --status r1i*n*
```

This command issues an `ipmitool power off` command to all of the nodes specified by the wildcard, as follows:

```
# cpower --off r2i*n*
```

The default is to apply to a node.

The following commands behave exactly as you would expect as if you were using `ipmitool`, and have no special extra logic for ordering:

- `# cpower --up r1i*n*`
- `# cpower --reset r1i*n*`
- `# cpower --cycle r1i*n*`
- `# cpower --identify 5 r1i*n*`

Note: `--up` is a synonym for `--on` and `--down` is a synonym for `--off`.

IRU, Rack, and System Domains

The `cpower` command contains more logic when you go up to higher levels of abstraction, for example, using `--iru`, `--rack`, and `--system`. These higher level domain specifiers tell the command to be smart about how to order various of the actions that you give on the command line.

The `--iru` option tells the command to use correct ordering with IRU power commands. In this case, it firsts connect to the CMC on each IRU in rack 1 to issue the `power on` command, which turns on power to the IRU chassis (this is not the equivalent `ipmitool` command). Then it powers up the compute nodes in the IRU. Powering things down is the opposite, with the power to the IRU being turned off after power to the blades. IRU targets are specified as follows: `r3i2` for rack 3, IRU 2.

```
# cpower --iru --up r1i*
```

The `--rack` option ensures power commands to the leader node are down in the correct order relative to compute nodes within a rack. First, it powers up the leader node and waits for it to boot up (if it is not already up). Then it will do the functional equivalent of a `cpower --iru --up r4i*` on each of the IRUs contained in the rack, including applying power to each IRU chassis. Using the `--down` option is the opposite, and also turns off the leader node (after doing a shutdown) after all the IRUs are powered down. To avoid including leader nodes in a power command for a rack, use the `--noleader` option. Rack targets are specified, as follows: `r4` for rack 4. Here is an example:

```
# cpower --rack --up r4
```

Commands with the `--system` option ensures that power up commands are applied first to service nodes, then to leader nodes, then to IRUs and compute blades, in just the same way. Likewise, compute blades are powered down before IRUs, leader nodes, and service nodes, in that order. To avoid including service nodes in a system-domain command, use the `--noservice` option. Note that you must not specify a target with `--system` option, since it applies to the Altix ICE system.

Shutting Down and Booting

Note: The `--shutdown --off` combination of actions were deprecated in the SGI Tempo v1.2 release. Use the `--halt` option in it's place.

It useful to be able to shutdown a machine before turning off the power, in most cases. The following `cpower` options to enable you to do this: `--halt`, `--boot`, and `--reboot`. The `--halt` option allows you to shut down a node. The `--reboot` option ensures that a system is always rebooted, whereas `--boot` will only boot up a system if it is not already booted. Thus, `--boot` is useful for booting up compute blades that have failed to start.

You need to configure the order in which service nodes are booted up and shut down as part of the overall system power management process. This is done by setting a `boot_order` for each service node. Use the `cadmin` command to set the boot order for a service node, for example:

```
# cadmin --set-boot-order --node service0 2
```

The `cpower --system --boot` command boots up service nodes with a lower boot order, first. It then boots up service nodes with a higher boot order. The reverse is true when shutting down the system with `cpower`. For example, if `service1` has a boot order of 3 and `service2` has a boot order of 5, `service1` is booted completely, and then `service2` is booted, afterwards. During shutdown, `service2` is shut down completely before `service1` is shutdown.

There is a special meaning to a service node having a boot order of zero. This value causes the `cpower --system` command to skip that service node completely for both start up and shutdown (although not for status queries). Negative values for the service node boot order setting are not permitted.

Note: The IPMI power commands necessary to enable a system to boot (either with a power reset, or a power on) may be sent to a node. The `--halt` option, halts the target node and then powers it off.

The `--halt` options works on node, IRU, or rack domain levels. It will shut down nodes (in the correct order if you use the `--iru` or `--rack` options), and then just leave them as they are, power still applied. Using both these actions results in nodes being halted, then powered off. This is particularly useful when powering off a rack, since otherwise, the leaders may be shutdown before there is a chance to power off the compute blades. Here is an example:

```
# cpower --halt --rack r1
```

To boot up systems that have not already been booted, perform the following:

```
# cpower --boot r1i2n*
```

Again, the command boots up nodes in the right orders if you specify the `--iru` or `--rack` options and the appropriate target. Otherwise, there is no guarantee that, for example, the command will attempt to power on the leader node before compute nodes in the same rack.

To reboot all of the nodes specified, or boot them if they are already shut down, perform the following:

```
# cpower --reboot --iru r3i3
```

The `--iru` or `--rack` options ensure proper ordering if you use them. In this case, the command will make sure that power is supplied to the chassis for rack 3, IRU 3, and then the all the compute nodes in that IRU will be rebooted.

EXAMPLES

Example 3-3 `cpower` Command Examples

To boot compute blade `r1i0n8`, perform the following:

```
# cpower --boot r1i0n8
```

To boot a number of compute blades at the same time, perform the following:

```
# cpower --boot --rack r1
```

Note: The `--boot` option will only boot those nodes that have not already booted.

To shut down service node 0, perform the following:

```
# cpower --halt service0
```

To shutdown and switch off everything in rack 3, perform the following:

```
# cpower --halt --rack r3
```

Note: This command will shutdown and then power off all of the computer nodes in parallel, then shutdown and power off the leader node. Use the `--noleader` option if you want the leader node to remain booted up.

To shutdown the entire system, including all service nodes and all leader nodes, but not the admin node, and not turn the power off to anything, perform the following:

```
# cpower --halt --system
```

To shutdown all the compute nodes, but not the service nodes, leader nodes, perform the following:

```
# cpower --halt --system --noleader --noservice
```

Note: The only way to shut down the system admin controller (admin node) is to perform the operation manually.

C3 Commands

This section describes the cluster command and control (C3) tool suite for cluster administration and application support.

Note: The SGI Tempo version of C3 does not include the `cshutdown` and `cpushimage` commands.

The C3 commands used on the the SGI Alitx ICE 8200 system are, as follows:

C3 Utilities	Description
<code>cexec(s)</code>	Executes a given command string on each node of a cluster
<code>cget</code>	Retrieves a specified file from each node of a cluster and places it into the specified target directory
<code>ckill</code>	Runs <code>kill</code> on each node of a cluster for a specified process name
<code>clist</code>	Lists the names and types of clusters in the cluster configuration file
<code>cnum</code>	Returns the node names specified by the range specified on the command line
<code>cname</code>	Returns the node positions specified by the node name given on the command line

`cpush` Pushes files from the local machine to the nodes in your cluster

`cexec` is the most useful C3 utility. Use the `cpower`, `power-iru`, `power-rack`, and `power-system` commands rather than `cshutdown` (see "Power Management Commands" on page 154).

EXAMPLES

Example 3-4 C3 Command General Examples

The following examples walk you through some typical C3 command operations.

You can use the `cname` and `cnum` commands to map names to locations and vice versa, as follows:

```
# cname rack_1:0-2
local name for cluster: rack_1
nodes from cluster: rack_1
cluster: rack_1 ; node name: r1i0n0
cluster: rack_1 ; node name: r1i0n1
cluster: rack_1 ; node name: r1i0n10
```

```
# cnum rack_1: r1i0n0
local name for cluster: rack_1
nodes from cluster: rack_1
r1i0n0 is at index 0 in cluster rack_1
```

```
# cnum rack_1: r1i0n1
local name for cluster: rack_1
nodes from cluster: rack_1
```

You can use the `clist` command to retrieve the number of racks, as follows:

```
# clist
cluster rack_1 is an indirect remote cluster
cluster rack_2 is an indirect remote cluster
cluster rack_3 is an indirect remote cluster
cluster rack_4 is an indirect remote cluster
```

You can use the `cexec` command to view the addressing scheme of the C3 utility, as follows:

```
# cexec rack_1:1 hostname
***** rack_1 *****
***** rack_1 *****
----- rli0n1-----
rli0n1

# cexec rack_1:2-3 rack_4:0-3,10 hostname
***** rack_1 *****
***** rack_1 *****
----- rli0n10-----
rli0n10
----- rli0n11-----
rli0n11
***** rack_4 *****
***** rack_4 *****
----- r4i0n0-----
r4i0n0
----- r4i0n1-----
r4i0n1
----- r4i0n10-----
r4i0n10
----- r4i0n11-----
r4i0n11
----- r4i0n4-----
r4i0n4
```

The following set of command shows how to use the C3 commands to transverse the different levels of hierarchy in your Altix ICE system (for information on the hierarchical design of your Altix ICE system see "Basic System Building Blocks" on page 1).

To execute a C3 command on all blades within the default Altix ICE system, for example, rack 1, perform the following:

```
# cexec hostname
***** rack_1 *****
***** rack_1 *****
----- rli0n0-----
```

```

r1i0n0
----- r1i0n1-----
r1i0n1
----- r1i0n10-----
r1i0n10
----- r1i0n11-----
r1i0n11

...

```

To run a C3 command on all compute nodes across an Altix ICE system, perform the following:

```

# cexec --all hostname
***** rack_1 *****
***** rack_1 *****
----- r1i0n0-----
r1i0n0
----- r1i0n1-----
r1i0n1
...
----- r2i0n10-----
r2i0n10
...
----- r3i0n11-----
r3i0n11
...

```

To run a C3 command against the first rack leader controller, in the first rack, perform the following:

```

# cexec --head hostname
***** rack_1 *****
----- rack_1-----
r1lead

```

To run a C3 command against all rack leader controllers across all racks, perform the following:

```

# cexec --head --all hostname
***** rack_1 *****

```

```
----- rack_1-----  
r1lead  
***** rack_2 *****  
----- rack_2-----  
r2lead  
***** rack_3 *****  
----- rack_3-----  
r3lead  
***** rack_4 *****  
----- rack_4-----  
r4lead
```

The following set of examples shows some specific case uses for the C3 commands that you are likely to employ.

Example 3-5 C3 Command Specific Use Examples

From the **system admin controller**, run command on rack 1 without including the rack leader controller, as follows:

```
# cexec rack_1: <cmd>
```

Run a command on all service nodes only, as follows:

```
# cexec -f /etc/c3svc.conf <cmd>
```

Run a command on all compute nodes in the system, as follows:

```
# cexec --all <cmd>
```

Run a command on all rack leader controllers, as follows:

```
# cexec --all --head <cmd>
```

Run a command on blade 42 (compute node 42) in rack 2, as follows:

```
# cexec rack_2:42 <cmd>
```

From a **service node** over the InfiniBand Fabric, run a command on all blades (compute nodes) in the system, as follows:

```
# cexec --all <cmd>
```

Run a command on blade 42 (compute node 42), as follows:

```
# cexec blades:42 <cmd>
```

cadmin: SGI Tempo Administrative Interface

The `cadmin` command allows you to change certain administrative parameters in the cluster such as the boot order of service nodes, the administrative status of nodes, and the adding, changing, and removal of IP addresses associated with service nodes.

Note: The `cadmin --db-purge --node` option is new for this release. Use this command if you want to permanently remove a node from the database rather than discover command `--delrack` and `--delservice` options (for more information, see "discover Command" on page 68).

To get the `cadmin` usage statement, perform the following:

```
# cadmin --h
cadmin: SGI Tempo Administrative Interface
Help:
```

In general, these commands operate on {node}. {node} is the Tempo style node name. For example, `service0`, `r1lead`, `r1i0n0`. Even when the host name for a service node is changed, the Tempo name for that node may still be used for {node} below. The node name can either be the tempo unique node name or a customer-supplied host name associated with a tempo unique node name.

```
--version : Display current release information
--set-admin-status --node {node} {value} : Set Administrative Status
--show-admin-status --node {node} : Show Administrative Status
--show-ops-status [--one-per-line] [--node {node}] : Show Operational Status
--set-boot-order --node {node} [value] : Set boot order [1]
--show-boot-order --node {node} : Show boot order [1]
--set-ip --node {node} --net {net} {hostname}={ip} : Change an allocated ip [1]
--del-ip --node {node} --net {net} {hostname}={ip} : Delete an ip [1]
--add-ip --node {node} --net {net} {hostname}={ip} : allocate a new ip [1]
--show-ips --node {node} : Show all allocated IPs associated with node
--set-hostname --node {node} {new-hostname} : change the host name [1]
--show-hostname --node {node} : show the current host name for ice node {node}
--set-subdomain {domain} : Set the cluster subdomain [3]
--show-subdomain : Show the cluster subdomain
--set-admin-domain {domain} : Set the admin node house network domain
--show-admin-domain : Show the admin node house network domain
--db-purge --node {node} : Purge service or lead node (incl entire rack) from DB
--set-external-dns --ip {ip} : Set IP addr(s) of external DNS master(s) [4]
```

```
--show-external-dns : Show the IP addr(s) of the external DNS master(s)
--del-external-dns : Delete the configuration of external DNS master(s)
--show-root-labels : Show grub root labels if multiple roots are in use
--set-root-label --slot {#} --label {label} : Set changeable part of root label
--show-default-root : Show default root if multiple roots are in use
--set-default-root --slot {#} : Set the default slot if multiple roots in use
```

Node-attribute options:

```
--add-attribute [--string-data "{string}"] [--int-data {int}] {attribute-name}
--is-attribute {attribute-name}
--delete-attribute {attribute-name}
--set-attribute-data [--string-data "{string}"] [--int-data {int}]
  {attribute-name}
--get-attribute-data {attribute-name}
--search-attributes [--string-data "{string|regex}"] [--int-data {int}]
--add-node-attribute [--string-data "{string}"] [--int-data {int}]
  --node {node} --attribute {attribute-name}
--is-node-attribute --node {node} --attribute {attribute-name}
--delete-node-attribute --node {node} --attribute {attribute-name}
--set-node-attribute-data [--string-data "{string}"] [--int-data {int}]
  --node {node} --attribute {attribute-name}
--get-node-attribute-data --node {node} --attribute {attribute-name}
--search-node-attributes [--node {node}] [--attribute {attribute-name}]
  [--string-data "{string|regex}"] [--int-data {int}]
```

Descriptions of Selected Values:

{hostname}={ip} means specify the host name associated with the specified ip address.

{net} is the tempo network to change such as ib-0, ib-1, head, gbe, bmc, etc

{node} is a tempo-style node name such as rlead, service0, or rli0n0.

[1] Only applies to service nodes

[2] This operation may require the cluster to be fully shut down and AC power to be removed. IPs will have to be re-allocated to fit in the new range.

[3] All cluster nodes will have to be reset

[4] Use quoted, semi-colon separated list if more than one master

EXAMPLES

Example 3-6 SGI Tempo Administrative Interface (cadmin) Command

Set a node offline, as follows:

```
# cadmin --set-admin-status --node r1i0n0 offline
```

Set a node online, as follows:

```
# cadmin --set-admin-status --node r1i0n0 online
```

Set the boot order for a service node, as follows:

```
# cadmin --set-boot-order --node service0 2
```

Add an IP to an existing service node, as follows:

```
# cadmin --add-ip --node service0 --net ib-0 my-new-ib0-ip=10.148.0.200
```

Change the Tempo needed service0-ib0 IP address, as follows:

```
# cadmin --set-ip --node service0 --net head service0=172.23.0.199
```

Show currently allocated IP addresses for service0, as follows:

```
# cadmin --show-ips --node service0
IP Address Information for Tempo node: service0
```

ifname	ip	Network
myservice-bmc	172.24.0.3	head-bmc
myservice	172.23.0.3	head
myservice-ib0	10.148.0.254	ib-0
myservice-ib1	10.149.0.67	ib-1
myhost	172.24.0.55	head-bmc
myhost2	172.24.0.56	head-bmc
myhost3	172.24.0.57	head-bmc

Delete a site-added IP address (you cannot delete Tempo needed IP addresses), as follows:

```
admin:~ # cadmin --del-ip --node service0 --net ib-0 my-new-ib0-2-ip=10.148.0.201
```

Change the hostname associated with service0 to be myservice, as follows:

```
admin:~ # cadmin --set-hostname --node service0 myservice
```

Set and show the cluster subdomain, as follows:

```
admin:~ # cadmin --set-subdomain mysubdomain.domain.mycompany.com
admin:~ # cadmin --show-subdomain
The cluster subdomain is: mysubdomain
```

Show the admin node house network domain, as follows:

```
admin:~ # cadmin --show-admin-domain
The admin node house network domain is: domain.mycompany.com
```

Console Management

SGI Tempo management systems software uses the open-source console management package called `conserver`. For detailed information on `conserver`, see <http://www.conserver.com/>

An overview of the `conserver` package is, as follows:

- Manages the console devices of all managed nodes in an Altix ICE system
- A `conserver` daemon runs on the system admin controller (admin node) and the rack leader controllers (leader nodes). The system admin controller manages leader and service node consoles. The rack leader controllers manage blade consoles.
- The `conserver` daemon connects to the consoles using `ipmitool`. Users connect to the daemon to access them. Multiple users can connect but non-primary users are read-only.
- The `conserver` package is configured to allow all consoles to be accessed from the system admin controller.
- All consoles are logged. These logs can be found at `/var/log/consoles` on the system admin controller and rack leader controllers. An `autofs` configuration file is created to allow you to access rack leader controller managed console logs from the system admin controller, as follows:

```
system-admin # /net/r1lead/var/log/consoles/
```

The `/etc/conserver.cf` file is the configuration file for the `conserver` daemon. This file is generated for both the system admin controller and rack leader controllers from the `/opt/sgi/sbin/generate-conserver-files` script on the system admin controller. This script is called from `discover-rack` command as part of rack

discovery or rediscovery and generates both the `conserver.cf` file for the rack in question and regenerates the `conserver.cf` for the system admin controller.

Note: The `conserver` package replaces `cconsole` for access to all consoles (blades, leader nodes, managed service nodes)

You may find the following `conserver` man pages useful:

Man Page	Description
<code>console(1)</code>	Console server client program
<code>conserver(8)</code>	Console server daemon
<code>conserver.cf(5)</code>	Console configuration file for <code>conserver(8)</code>
<code>conserver.passwd(5)</code>	User access information for <code>conserver(8)</code>

Procedure 3-8 Using `conserver` Console Manager

To use the `conserver` console manager, perform the following steps:

1. To see the list of available consoles, perform the following:

```
system-admin:~ # console -x
service0          on /dev/pts/2          at Local
r2lead            on /dev/pts/1          at Local
r1lead            on /dev/pts/0          at Local
r1i0n8            on /dev/pts/0          at Local
r1i0n0            on /dev/pts/1          at Local
```

2. To connect to the service console, perform the following:

```
system-admin:~ # console service0
[Enter '^Ec?' for help]
```

```
Welcome to SUSE Linux Enterprise Server 10 sp2 (x86_64) - Kernel 2.6.16.60-0.12-smp (ttyS1).
```

```
service0 login:
```

3. To connect to the rack leader controller console, perform the following:

```
system-admin:~ # console r1lead  
[Enter '^Ec?' for help]
```

```
Welcome to SUSE Linux Enterprise Server 10 sp2 (x86_64)  
- Kernel 2.6.16.60-0.12-smp (ttyS1).
```

```
r1lead login:
```

4. To trigger system request commands `sysrq` (once connected to a console), perform the following:

```
Ctrl-e c l l 8           # set log level to 8  
Ctrl-e c l l <sysrq cmd> # send sysrq command
```

5. To see the list of `conserver` escape keys, perform the following:

```
Ctrl-e c ?
```

Keeping System Time Synchronized

The SGI Tempo systems management software uses network time protocol (NTP) as the primary mechanism to keep the nodes in your Altix ICE system synchronized. This section describes this mechanism operates on the various Altix ICE components and covers these topics:

- "System Admin Controller NTP" on page 171
- "Rack Leader Controller NTP" on page 171
- "Managed Service, Compute, and Leader BMC Setup with NTP" on page 171
- "Service Node NTP" on page 171
- "Compute Node NTP" on page 171
- "NTP Work Arounds" on page 172

System Admin Controller NTP

When you used the `configure-cluster` command, it guided you through setting up NTP on the admin node. The NTP client on the system admin controller should point to the house network time server. The NTP server provides NTP service to system components so that nodes can consult it when they are booted. The system admin controller sends NTP broadcasts to some networks to keep the nodes in sync after they have booted.

Rack Leader Controller NTP

NTP client on the rack leader controller gets time from the system admin controller when it is booted and then stays in sync by connecting to the admin node for time. The NTP server on the leader node provides NTP service to Altix ICE components so that compute nodes can sync their time when they are booted. The rack leader controller sends NTP broadcasts to some networks to keep the compute nodes in sync after they have booted.

Managed Service, Compute, and Leader BMC Setup with NTP

The BMC controllers on managed service nodes, compute nodes, and leader nodes are also kept in sync with NTP. Note that you may need the latest BMC firmware for the BMCs to sync with NTP properly. The NTP server information for BMCs is provided by special options stored in the DHCP server configuration file.

Service Node NTP

The NTP client on *managed* service nodes (for a definition of managed, see "discover Command" on page 68) sets its time at initial booting from the system admin controller. It listens to NTP broadcasts from the system admin controller to stay in sync. It does not provide any NTP service.

Compute Node NTP

The NTP Client on the compute node sets its time at initial booting from the rack leader controller. It listens to NTP broadcasts from the rack leader controller to stay in sync.

NTP Work Arounds

Sometime, especially during initial deployment of an Altix ICE system when system components are being installed and configured for the first time, NTP is not available to serve time to system components.

A non-modified NTP server, running for the first time, takes quite some time before it offers service. This means the leader and service nodes may fail to get time from the system admin controller as they come on-line. Compute nodes may also fail to get time from the leader when they first come up. This situation usually only happens at first deployment. After the `ntp` servers have a chance to create their drift files, `ntp` servers offer time with far less delay on subsequent reboots.

The following work arounds are in place for situations when NTP can not serve the time:

- The admin and rack leader controllers have the `time` service enabled (`xinetd`).
- All system node types have the `netdate` command.
- A special startup script is on leader, service, and compute nodes that runs before the NTP startup script.

This script attempts to get the time using the `ntpdate` command. If the `ntpdate` command fails because the NTP server it is using is not ready yet to offer time service, it uses the `netdate` command to get the clock "close".

The `ntp` startup script starts the NTP service as normal. Since the clock is known to be "close", NTP will fix the time when the NTP servers start offering time service.

Changing the Size of `/tmp` on Compute Nodes

This section describes how to change the size of `/tmp` on Altix ICE compute nodes.

Procedure 3-9 Increasing the `/tmp` Size

To change the size of `/tmp` on your system compute nodes, perform the following steps:

1. From the admin node, change directory (`cd`) to `/opt/sgi/share/per-host-customization/global`.

2. Open the `sgi-fstab` file and change the `size=` parameter for the `/tmp` mount, as shown in the example below:

```
#!/bin/sh
#
# Copyright (c) 2007 Silicon Graphics, Inc.
# All rights reserved.
#
# Set up the compute node's /etc/fstab file.
#
# Modify per your sites requirements.
#
# This script is executed once per-host as part of the install-image operation
# run on the leader nodes, which is called from cimage on the admin node.
# The full path to the per-host iru+slot directory is passed in as $1,
# e.g. /var/lib/sgi/per-host//i2n11.
#
# sanity checks
. /opt/sgi/share/per-host-customization/global/sanity.sh

iruslot=$1

cat <${iruslot}/etc/fstab
#           tmpfs           /tmp           tmpfs   size=48m       0       0
EOF
```

3. Push the image out to the racks to pick up the change, as follows:

```
# cimage --push-rack mynewimage r\*
```

For more information on using the `cimage` command, see "cimage Command" on page 141.

Disabling Swap Space

This section describes how to disable swap space on your Altix ICE system.

Procedure 3-10 Disabling Swap Space

To disable swap space, from the admin node, perform the following steps:

1. Turn off swapping, as follows:

```
admin:~# chroot /var/lib/systemimager/images/compute-sles10sp2 chkconfig iscsiswap off
```

2. Push the new image out to the compute nodes, as follows:

```
admin:~# cimage --push-rack compute-sles10sp2 r\*
```

3. Power on or reboot the compute nodes (see "Shutting Down and Booting" on page 157).

Changing the Size of Per-node Swap Space

This section describes how to change per-node swap space on your SGI Altix ICE system.

Procedure 3-11 Increasing Per-node Swap Space

To increase the default size of the per-blade swap space on your system, perform the following:

1. Shutdown all blades in the affected rack (see "Shutting Down and Booting" on page 157).
2. Log into the leader node for the rack in question. (Note that you need to do this on each rack leader).
3. Change directory (cd) to the `/var/lib/sgi/swapfiles` directory.
4. To adjust the swap space size appropriate for your site, run a script similar to the following:

```
#!/bin/bash

size=262144      # size in KB

for i in $(seq 0 3); do
    for n in $(seq 0 15); do
        dd if=/dev/zero of=i${i}n${n} bs=1k count=${size}
        mkswap i${i}n${n}
    done
done
```

5. Reboot the all blades in the affected rack (see "Shutting Down and Booting" on page 157).
6. From the rack leader node, use the `cexec --all free` command to run the `free(1)` command on the compute blades to view the new swap sizes, as follows:

```

rlllead:~ # cexec --all free
***** rack_1 *****
----- rli0n0-----
      total      used      free      shared    buffers    cached
Mem:      2060140  206768  1853372         0         4      46256
-/+ buffers/cache:  160508  1899632
Swap:      49144         0      49144
----- rli0n1-----
      total      used      free      shared    buffers    cached
Mem:      2060140  137848  1922292         0         4      44200
-/+ buffers/cache:   93644  1966496
Swap:      49144         0      49144
----- rli0n8-----
      total      used      free      shared    buffers    cached
Mem:      2060140  138076  1922064         0         4      43172
-/+ buffers/cache:   94900  1965240
Swap:      49144         0      49144

```

If you want change per-node swap space across your entire system, all (new) leaders nodes as part of discovery, you can edit the `/etc/opt/sgi/conf.d/35-compute-swapfiles` “inside” the `lead-sles10sp2` image on the admin node. The images are in the `/var/lib/systemimager/images` directory. For more information on customizing these images, see "Customizing Software Images" on page 137.

Switching Compute Nodes to a `tmpfs` Root

This section describes how to switch your system compute nodes to a `tmpfs` root.

Procedure 3-12 Switching Compute Nodes to a `tmpfs` Root

To switch your compute nodes to a `tmpfs` root, from the system admin controller (admin node) perform the following steps:

1. To switch compute nodes to a `tmpfs` root, use the optional `--tmpfs` flag to the `cimage --set` command, for example:

```
adminadmin:~ # cimage --set --tmpfs compute-sles10sp2 2.6.16.60-0.21-smp r1i0n0
```

Note: To use a `/tmpfs` root with the standard compute node image, the compute node needs to have 4GB of memory or above. A standard `/tmpfs` mount has access to half the system memory, and the standard compute node image is just over 1 GB in size.

2. You can view the current setting of a compute node, as follows:

```
admin:~ # cimage --list-nodes r1i0n0
r1i0n0: compute-sles10sp2 2.6.16.60-0.21-smp tmpfs
```

3. To set it back to an NFS root, use the `--nfs` flag to the `cimage --set` command, as follows:

```
admin:~ # cimage --set --nfs compute-sles10sp2 2.6.16.60-0.21-smp r1i0n0
```

4. You can change the view the change back to NFS root, as follows:

```
admin:~ # cimage --list-nodes r1i0n0
r1i0n0: compute-sles10sp2 2.6.16.60-0.21-smp nfs
```

For help information, use the `cimage --h` option.

Viewing the Compute Node Read-Write Quotas

This section describes how to view the per compute node read and write quota.

Procedure 3-13 Viewing the Compute Node Read-Write Quotas

To view the per compute node read and write quota, log onto the leader node and perform the following:

```
r1lead:~ # xfs_quota -x -c 'quota -ph 1'
Disk quotas for Project #1 (1)
Filesystem  Blocks  Quota  Limit Warn/Time    Mounted on
/dev/disk/by-label/sgiroot
           64.6M    0    1G  00 [-----] /
```

Map the XFS project ID to the quota you are interested in by looking it up in `/etc/projects` file.

If you decided to change the `xfs_quota` values, log back onto the admin node and edit the `/etc/opt/sgi/cminfo` file **inside** the compute image where you want to change the value, for example, `/var/lib/systemimager/images/image_name`. Change the value of the `PER_BLADE_QUOTA` variable and then repush the image with the following command:

```
# cimage --push-rack image_name racks
```

For help information, perform the following:

```
xfs_quota> help
df [-bir] [-hn] [-f file] -- show free and used counts for blocks and inodes
help [command] -- help for one or all commands
print -- list known mount points and projects
quit -- exit the program
quota [-bir] [-gpu] [-hnv] [-f file] [id|name]... -- show usage and limits
```

Use 'help commandname' for extended help

Use help *commandname* for extended help, such as the following:

```
xfs_quota> help quota
```

```
quota [-bir] [-gpu] [-hnv] [-f file] [id|name]... -- show usage and limits

display usage and quota information

-g -- display group quota information
-p -- display project quota information
-u -- display user quota information
-b -- display number of blocks used
-i -- display number of inodes used
-r -- display number of realtime blocks used
-h -- report in a human-readable format
-n -- skip identifier-to-name translations, just report IDs
-N -- suppress the initial header
-v -- increase verbosity in reporting (also dumps zero values)
-f -- send output to a file
The (optional) user/group/project can be specified either by name or by
number (i.e. uid/gid/projid).
```

```
xfs_quota>
```

RAID Utility

The infrastructure nodes on your Altix ICE system have LSI RAID enabled by default from the factory. A `lsiutil` command-line utility is included with the installation for the admin node, the leader node, and the service node (when installed from the SGI service node image). This tool allows you to look at the devices connected to the RAID controller and manage them. Some functions, such as, setting up mirrored or striped volumes, can be handled either by the LSI BIOS configuration tool or the `lsiutil` utility.

Note: These instructions only apply to Altix XE250 systems with the 1068-based controller. They do not apply to Altix XE250 systems that have the LSI Megaraid controller.

Example 3-7 Using the `lsiutil` Utility

The following `lsiutil` command-line utility example shows a sample session, as follows:

Start the `lsiutil` tool, as follows:

```
admin:~ # lsiutil
```

```
LSI Logic MPT Configuration Utility, Version 1.54, January 22, 2008
```

```
1 MPT Port found
```

	Port Name	Chip Vendor/Type/Rev	MPT Rev	Firmware Rev	IOC
1.	/proc/mpt/ioc0	LSI Logic SAS1068E B2	105	01140100	0

```
Select a device: [1-1 or 0 to quit]
```

Select **1** to show the **MPT Port**, as follows:

```
1 MPT Port found
```

	Port Name	Chip Vendor/Type/Rev	MPT Rev	Firmware Rev	IOC
1.	/proc/mpt/ioc0	LSI Logic SAS1068E B2	105	01140100	0

Select a device: [1-1 or 0 to quit] 1

1. Identify firmware, BIOS, and/or FCode
2. Download firmware (update the FLASH)
4. Download/erase BIOS and/or FCode (update the FLASH)
8. Scan for devices
10. Change IOC settings (interrupt coalescing)
13. Change SAS IO Unit settings
16. Display attached devices
20. Diagnostics
21. RAID actions
22. Reset bus
23. Reset target
42. Display operating system names for devices
45. Concatenate SAS firmware and NVDATA files
60. Show non-default settings
61. Restore default settings
69. Show board manufacturing information
97. Reset SAS link, HARD RESET
98. Reset SAS link
99. Reset port
- e Enable expert mode in menus
- p Enable paged mode in menus
- w Enable logging

Main menu, select an option: [1-99 or e/p/w or 0 to quit]

Choose 21. RAID actions, as follows:

Main menu, select an option: [1-99 or e/p/w or 0 to quit] **21**

1. Show volumes
2. Show physical disks
3. Get volume state
4. Wait for volume resync to complete
23. Replace physical disk
26. Disable drive firmware update mode
27. Enable drive firmware update mode
30. Create volume
31. Delete volume
32. Change volume settings

```
50. Create hot spare
99. Reset port
   e Enable expert mode in menus
   p Enable paged mode in menus
   w Enable logging
```

RAID actions menu, select an option: [1-99 or e/p/w or 0 to quit]

Choose 2. Show physical disks, to show the status of the disks making up the volume, as follows:

RAID actions menu, select an option: [1-99 or e/p/w or 0 to quit] **2**

1 volume is active, 2 physical disks are active

```
PhysDisk 0 is Bus 0 Target 1
  PhysDisk State: online
  PhysDisk Size 238475 MB, Inquiry Data: ATA      Hitachi HDT72502 A73A
```

```
PhysDisk 1 is Bus 0 Target 2
  PhysDisk State: online
  PhysDisk Size 238475 MB, Inquiry Data: ATA      Hitachi HDT72502 A73A
```

RAID actions menu, select an option: [1-99 or e/p/w or 0 to quit]

Choose 1. Show volumes, to show information about the volume including its health, as follows:

RAID actions menu, select an option: [1-99 or e/p/w or 0 to quit] **1**

1 volume is active, 2 physical disks are active

```
Volume 0 is Bus 0 Target 0, Type IM (Integrated Mirroring)
  Volume Name:
  Volume WWID: 09195c6d31688623
  Volume State: optimal, enabled
  Volume Settings: write caching disabled, auto configure
  Volume draws from Hot Spare Pools: 0
  Volume Size 237464 MB, 2 Members
  Primary is PhysDisk 1 (Bus 0 Target 2)
  Secondary is PhysDisk 0 (Bus 0 Target 1)
```

RAID actions menu, select an option: [1-99 or e/p/w or 0 to quit]

Backing up and Restoring the System Database

The SGI Tempo systems management software captures the relevant data for the managed objects in an SGI Altix ICE system. Managed objects are the hierarchy of nodes described in "Basic System Building Blocks" on page 1. The system database is critical to the operation of your SGI Altix ICE system and you need to back up the database on a regular basis.

Managed objects on an SGI Altix ICE include the following

- Altix ICE system

One ICE system is modeled as a meta-cluster. This meta-cluster contains the racks each modeled as a sub-cluster.

- Nodes

System admin controller (admin node), rack leader controllers (leader nodes), service nodes, compute nodes (blades) and chassis management control blades (CMCs) are modeled as nodes.

- Networks

The preconfigured and potentially customized IP networks

- Nics

The network interfaces for Ethernet and InfiniBand adapters.

- The network interfaces for Ethernet and InfiniBand adapter.

The node images installed on each particular node.

SGI recommends that you keep three backups of your system database at any given time. You should implement a rotating backup procedure following the son-father-grandfather principle.

Procedure 3-14 Backing up and Restoring the System Database

To back up and restore the system database, perform the following steps:

- 1.

Note: A password is required to use the `mysqldump` command. The password file is located in the `/etc/odapw` file.

From the system admin controller, to back up the system database perform a command similar to the following:

```
# mysqldump --opt oscar > backup-file.sql
```

2. To read the dump file back into the system admin controller, perform a command similar to the following:

```
# mysql oscar < backup-file.sql
```

For more information, see the `mysqldump(1)` man page.

System Fabric Management

The InfiniBand network on SGI Altix ICE 8200 series systems uses Open Fabrics Enterprise Distribution (OFED) software. This section describes the InfiniBand fabric and how to manage it. For background information on OFED, see <http://www.openfabrics.org>.

InfiniBand Fabric Management

This section describes the InfiniBand fabric and covers the following topics:

- "InfiniBand Fabric Overview" on page 183
- "Fabric Component" on page 184
- "InfiniBand Fabric Administrative Commands" on page 190
- "InfiniBand Fabric Management Configuration and Operation Overview" on page 199
- "InfiniBand Fabric Failover Mechanism" on page 206
- "Configuring and Initializing the InfiniBand Fabric Manually" on page 210
- "Useful Utilities and Diagnostics" on page 213

InfiniBand Fabric Overview

Fabric management on SGI Altix ICE 8200 series systems uses the OFED OpenSM software package. The InfiniBand fabric connects the service nodes, rack leader controllers (leader nodes), and the compute nodes. It does not connect to the system admin controller (admin node) or the chassis management control (CMC) blades. The InfiniBand network has two separate network fabrics, `ib0` and `ib1` (see "InfiniBand Fabric" on page 21) with the following characteristics:

- Each network fabric has its own subnet manager (SM).
- For a system with two racks or more, one rack leader controller (leader node) runs an instance of SM to manage the `ib0` fabric and a second leader node runs an instance of SM to manage the `ib1` fabric. A database on the admin node keeps a

record of which rack leader nodes are running the fabric management software for either `ib0` or `ib1`, respectively. The `smadmin` command has the logic to place `opensm` on the appropriate rack leader controller. If one of the rack leader controllers becomes unavailable, management of fabric can be assigned to another available rack leader node in the system.

Note: The LX series only has one `ib` fabric, therefore, the `smconfig/smadmin` commands, should only be run on `ib0` (see "InfiniBand Fabric Administrative Commands" on page 190).

- On a system with a single rack, both instances of `opensm` run on the same rack leader node.
- Each instance of SM on the rack leader controller is controlled by the `/etc/ofa/opensm-ib[01].conf` configuration file. For more information, see "smconfig Fabric Configuration Command" on page 193.
- Rack leader controllers run the `opensm` daemon for each fabric over separate HCA ports (see Figure 1-9 on page 22).

Note: After a system reboot, the `opensm` daemons start running automatically on the InfiniBand fabric.

- Each fabric is addressed by a global unique identifier (GUID) and unique HCA port.

The GUID and HCA port is set in the configuration file.

Note: Currently, the InfiniBand fabric `ib0` is reserved for MPI and the InfiniBand fabric `ib1` is reserved for storage.

Fabric Component

The SGI fabric component is used to verify the InfiniBand fabric in SGI cluster systems. Currently, it is supported on SGI Altix ICE systems running SGI Tempo software. The fabric component software contains a command line interface (CLI) called `sgifmcli(8)`. It allows you (or a program) to initialize various InfiniBand switches or verify the correctness of an InfiniBand fabric. For more information, see the `sgifmcli(8)` man page.

Currently, the following switches are supported:

Switch Type	Description
voltaire-isr-9024	Voltaire ISR 9024
voltaire-isr-2004	Voltaire ISR 2004
voltaire-isr-2012	Voltaire ISR 2012

For the Tempo v1.6 release, the `sgifmcli`, `smconfig` and `smadmin` commands are all available. In a future release, the `smconfig` and `smadmin` functionality will be integrated into the `sgifmcli` command. For the Tempo v1.6 release, the `smconfig`, `smadmin` and the `tempo-configure-fabric` command are used to configure the InfiniBand network and remain the only administrative tools to set up the InfiniBand fabric. For this release, the `sgifmcli` command has two purposes:

- Initialize and configure external InfiniBand switches

This is done automatically by the Tempo discover script (see "discover Command" on page 68) but can also be done manually by an administrator. For this operation no cluster wide InfiniBand connectivity needs to exist. The only necessity is that the supplied host name is resolvable and provides a working networking connection the external InfiniBand switch.

- Verify the InfiniBand fabric

This operation requires that the InfiniBand network is configured properly using the `tempo-configure-fabric` (see "InfiniBand Fabric Management Command" on page 191). Or you can use the equivalent `smconfig` and the `smadmin` commands to configure and start the fabric (see "smconfig Fabric Configuration Command" on page 193 and "smadmin InfiniBand Fabric Administration Command" on page 195).

`sgifmcli` SGI Fabric Component Command

The `sgifmcli` command is, as follows:

```
sgifmcli [type action [options]] | [options]
```

It accepts the following general options:

General Option	Description
<code>-h</code> , <code>--help</code>	Displays a help message and the exits

`-v, --version` Shows the version number of the program

It accepts the following detailed options:

Detailed Option	Description
type	<p>The <code>type</code> option is one of the following:</p> <ul style="list-style-type: none"> • <code>--ibswitch</code> - InfiniBand switch • <code>--ibfabric</code> - InfiniBand fabric
action	<p>The <code>action</code> option is one of the following:</p> <ul style="list-style-type: none"> • <code>--init</code> - Initializes the switch or fabric • <code>--verify</code> - Verifies the switch or fabric • <code>--remove</code> - Removes the switch or fabric
options	<p>The <code>options</code> option is one or more of the following with no duplicates, for example, the <code>--fabric</code> option must be either <code>ib0</code> or <code>ib1</code>, not both:</p> <ul style="list-style-type: none"> • <code>--id</code> - Unique identifier, for example, host name • <code>--model</code> - Switch model (<code>voltaire-isr-9024</code>, <code>voltaire-isr-2004</code>, or <code>voltaire-isr-2012</code>) • <code>--fabric</code> - Fabric, for example <code>ib0</code> or <code>ib1</code>)

EXAMPLES

Example 4-1 Initialize an External InfiniBand Switch

To initialize any InfiniBand switch, run the following command:

```
# sgifmcli --ibswitch --init --model <model> --fabric <ib0|ib1> --id <id>
```

For example, to initialize the `voltaire-isr-9024` switch model for the `ib0` fabric and name the switch `voltsw01`, run the following command:

```
# sgifmcli --ibswitch --init --model voltaire-isr-9024 --fabric ib0 --id voltsw01
```

Example 4-2 Change Settings for External InfiniBand Switch

To change the identifier for an already initialized switch, you first need to first remove the switch and then reinitialize, it again. To remove the switch, perform the following:

```
# sgifmcli --remove --id <id>
```

To remove `voltsw01` switch from the fabric component, perform the following:

```
# sgifmcli --remove --id voltsw01
```

To then reinitialize the switch, perform the command in Example 4-1, above.

Example 4-3 Remove an External InfiniBand Switch

To remove a switch from the fabric component, perform the following:

```
# sgifmcli --remove --id <id>
```

To remove `voltsw01` switch from the fabric component, perform the following:

```
# sgifmcli --remove --id voltsw01
```

Example 4-4 Verify the InfiniBand Fabric

This example walks you through some commands to verify the correct operation of your cluster system starting with how to initialize the fabric.

Before you run any job on your InfiniBand cluster you need to verify the correctness of it. However, before this you first need to initialize the fabric with the following command:

```
# sgifmcli --ibfabric --init --id <id>
```

For example, to initialize `ib0`, perform the following:

```
# sgifmcli --ibfabric --init --id ib0
```

After you initialize a fabric, verify correct operation with the following command:

```
# sgifmcli --ibfabric --verify --id <id>
```

For example, to verify `ib0`, perform the following:

```
# sgifmcli --ibfabric --verify --id ib0
```

Currently, the InfiniBand verifier performs the basic checks as recommended by OFED, additionally, it compares the available cluster nodes with the available InfiniBand nodes and points out differences. Here is an example output from the InfiniBand verifier:

```
..... // prints a dot very second

The IB verifier has found errors with your compute node(s).
-----
The following compute nodes are marked as online, but can not be accessed via IB:
rli0n0

The IB verifier has found errors with your ib0 fabric.
-----
-E- Disconnected switch:S0800690000002063/U1 in group:0xC020
-E- Disconnected HCA:rliln9/U1
-E- Disconnected HCA:rliln4/U1
-E- Disconnected switch:S0800690000002063/U1 in group:0xC022
-E- Disconnected HCA:rliln2/U1
-E- 2 multicast group checks failed
-E- Total Qualities Check Errors:6

The IB verifier has found errors with your ib1 fabric.
-----
-E- Disconnected switch:S0800690000002063/U1 in group:0xC020
-E- Disconnected HCA:rliln9/U1
-E- Disconnected HCA:rliln4/U1
-E- Disconnected switch:S0800690000002063/U1 in group:0xC022
-E- Disconnected HCA:rliln2/U1
-E- 2 multicast group checks failed
-E- Total Qualities Check Errors:6
```

Example 4-5 Getting `sgifmcli(8)` Command Help

For a `sgifmcli` command usage statement, perform the following from the admin node:

```
sys-admin:~ # sgifmcli -h

SGI Fabric Component CLI
Usage: sgifmcli [<type> <action> --id <value> [<option> [<value>]]*]

type is one of:
    --ibswitch      InfiniBand Switch
    --ibfabric      InfiniBand Fabric

action is one of:
    --init          Initialize
    --verify        Verify
    --remove        Remove

option is one or more (no dups) of:
    --id            Unique ID, e.g. voltsw01
    --model         Switch model, e.g. ['voltaire-isr-9024', 'voltaire-isr-2004', 'voltaire-isr-2012']
    --fabric        Fabric, e.g. ib0
    -v, --version   Print version
    -h, --help      Show this help text
```

For a detailed man page, perform the following command from the admin node:

```
sys-admin:~ # man sgifmcli
```

The `sgifmcli(8)` fabric administration utilities man page appears.

dbversion SGI Fabric Component Command

The fabric component maintains a database (DB) of the objects it manages (managed objects). The database version is automatically set during cluster install. You do not need to set it. Most likely, this database will change over time. To manage multiple database versions and also to aid in field support, SGI has added another command line tool that currently reports the managed objects database version.

The `dbversion` command is, as follows:

```
db_version [--set|-s] [--get|-g] [-v|--version] [--help|-h]
```

It accepts the following general options:

General Option	Description
<code>-s, --set</code>	Write DB version object to DB
<code>-g, --get</code>	Read DB version object from DB
<code>-v, --version</code>	Print version
<code>-h, --help</code>	<code>-h, -help</code>

Example 4-6 Getting `dbversion(8)` Command Help

For a `dbversion` command usage statement, perform the following from the admin node:

```
sys-admin:~ # dbversion -h
SGI Fabric Component DB Version
Usage: db_version [--set|-s] [--get|-g] [-v|--version] [--help|-h]

-s, --set      Write DB version object to DB
-g, --get      Read DB version object from DB
-v, --version  Print version
-h, --help     Show this text
```

Example 4-7 Getting the Database Version

To get the database version, perform the following command from the admin node:

```
sys-admin:~ # dbversion -g
DB version: 1.0
```

InfiniBand Fabric Administrative Commands

This section describes how to configure and administer your InfiniBand fabric and covers these topics:

- "InfiniBand Fabric Management Command" on page 191

- "smconfig Fabric Configuration Command" on page 193
- "smadmin InfiniBand Fabric Administration Command" on page 195

Note: The LX series only has one `ib` fabric, therefore, the `smconfig/smadmin` commands described in this section, should only be run on the `ib0` fabric.

InfiniBand Fabric Management Command

You can use the InfiniBand management command to configure or administer the InfiniBand fabric on your SGI Altix ICE system. You can use it to configure, start, stop, restart, cleanup, or get status for the InfiniBand fabric.

From the system admin controller (admin node), enter the following command:

```
sys-admin:~ # tempo-configure-fabric
```

The **InfiniBand Management Tool** GUI appears, as shown in Figure 4-1 on page 192.

You can also access this command from the `configure-cluster` main menu (see "configure-cluster Command Cluster Configuration Tool" on page 47). For more information, see Figure 4-1.

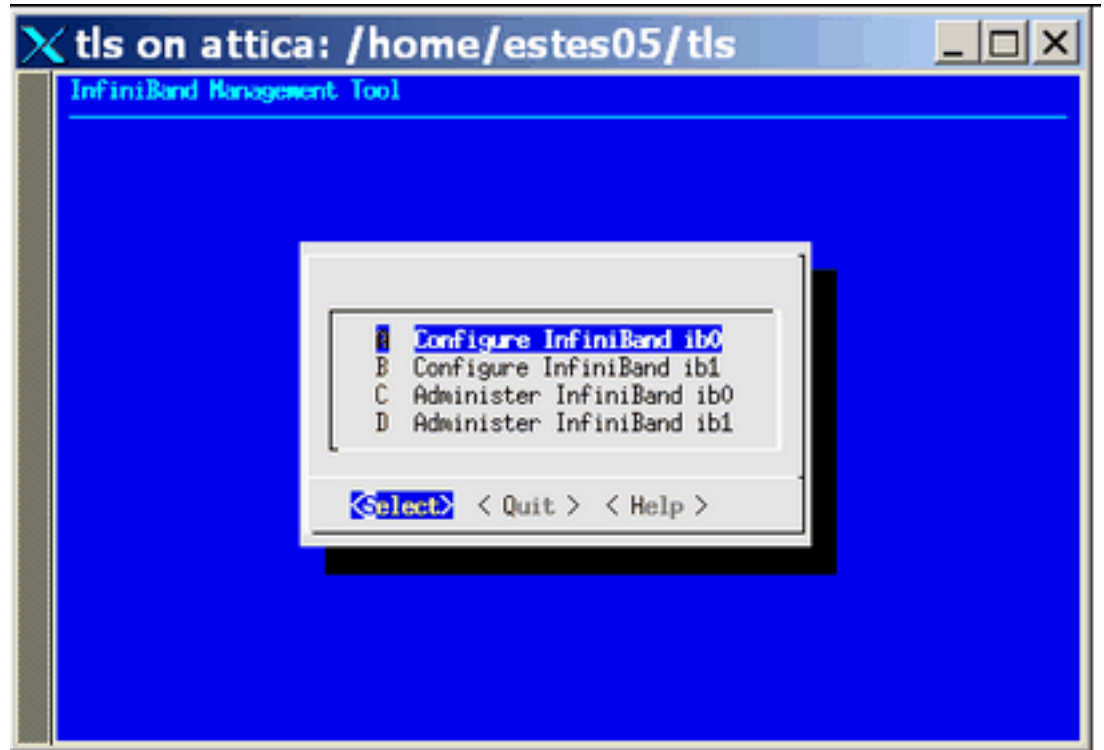

Figure 4-1 InfiniBand Management Tool Screen

Use the **Select** button to select the action you want to perform. A submenu will appear. Use the **Quit** button to return to the previous screen. Unless you are an expert user, SGI recommends that you use the InfiniBand Management GUI to manage your InfiniBand fabric rather than the `smconfig` and `smadmin` CLI commands. You can use the **Help** button to get online help for each of the GUI actions.

Note: From the **Configure InfiniBand** screen, make sure you select the **Configure Routing: dor** option to set the routing engine. Use `dor` variable for hypercube topology. Use `updn` variable for fat-tree topology. **(Required)** For more information, see "Network Topology" on page 204.

Use the the online help available with this tool to guide you through the InfiniBand configuration. After configuring and bringing up the InfiniBand network, select the **Administer InfiniBand ib0** option or the **Administer InfiniBand ib1** option, the **Administer InfiniBand** screen appears as shown in Figure 4-2. Verify the status via the **Status** option.

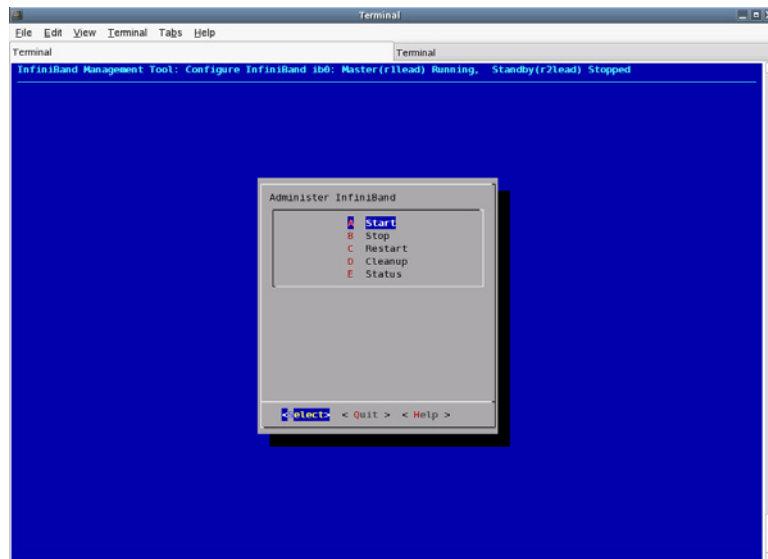

Figure 4-2 Administer InfiniBand Tool

smconfig Fabric Configuration Command

SGI Tempo also provides a command-line `smconfig` command that configures the fabric for you. "Configuring and Initializing the InfiniBand Fabric Manually" on page 210 describes how to manually configure a fabric and provides more detailed information on how fabric configuration works.

The `smconfig` command is, as follows:

```
smconfig [-f [ib0 | ib1] -e [dor | updn] OPTION] [-i] [?]
```

It accepts the following options:

Option	Description
-f [ib0 ib1]	Selects fabric ib0 or ib1 (Required)

-e [dor | updn] Use *dor* variable for hypercube topology. Use *updn* variable for fat-tree topology. **(Required)** For more information, see "Network Topology" on page 204.

OPTION Any combination of the following:

Note: The following options are optional and you can specify any combination of the options from *OPTION*.

- m *hostname* Configure MASTER, for example, *r1lead*
- s *hostname* Configure STANDBY, for example *r2lead*
- a *FILE* Specify external switch file
- i Initialize or reset configuration
- ? Provides a help statement for the command.

For MASTER / STANDBY service, SGI recommends the following placements:

```
# 1 Rack
# -----
# Leader 1: M(ib0), M(ib1)
# No standby
#
# 2 Racks
# -----
# Leader 1: M(ib0), S(ib1)
# Leader 2: M(ib1), S(ib0)
#
# 3 Racks
# -----
# Leader 1: M(ib0)
# Leader 2: M(ib1)
# Leader 3: S(ib0), S(ib1)
#
# >= 4 Racks
```

```
# -----
# Leader 1: M(ib0)
# Leader 2: M(ib1)
# Leader 3: S(ib0)
# Leader 4: S(ib1)
```

When using MASTER / STANDBY service, they **must** be located on different leader nodes. For example:

```
// MASTER: r1lead(172.20.10.1)
// STANDBY: r2lead(172.20.10.2)
```

From the system admin controller (admin node), use the following command:

```
admin:~ # smconfig -f ib0 -e dor -m r1lead -s r2lead
```

Procedure 4-1 Using the smconfig Command to Configure the InfiniBand Fabric

To configure the ib0 and ib1 InfiniBand fabrics on your system, perform the following:

1. From the system admin controller (admin node), perform the following command:

```
admin:~ # smconfig -f ib0 -e dor
Configuring r1lead
Configuring r2lead
Configuring r3lead
Configuring r4lead
```

2. Repeat the command for the ib1 fabric, as follows:

```
admin:~ # smconfig -f ib1 -e dor
Configuring r1lead
Configuring r2lead
Configuring r3lead
Configuring r4lead
```

smadmin InfiniBand Fabric Administration Command

SGI Tempo provides the smadmin command that allows you to start up or stop the ib0 and ib1 InfiniBand fabrics. You can also use this command to restart a fabric or get the status of a fabric. Use this command after your Altix ICE system has been discovered and is powered up (see "smconfig Fabric Configuration Command" on page 193).

The `smadmin` command is, as follows:

```
smadmin -f [ib0 | ib1] OPTION [-?]
```

It accepts the following options:

Option	Description
-f	Fabric <code>ib0</code> or fabric <code>ib1</code> (Required)
OPTION: (one of the following)	
-u	Start fabric management
-d	Stop fabric management
-r	Restart fabric management
-c	Attempt a fabric cleanup
-s	Get <code>opensmd</code> status (see "InfiniBand Fabric Management Configuration and Operation Overview" on page 199)
-m	Find <code>opensmd</code> MASTER node
-?	Provides a help statement for the command.

Note: For the SGI Tempo v1.5 release, the `-e` option has been deprecated.

Procedure 4-2 Using the `smadmin` Command to Administer the InfiniBand Fabric

The `opensm` instance for each fabric is run on different rack leader nodes. For example, the first rack leader controller discovered runs `opensm` for `ib0`, the second rack leader controller discovered runs `opensm` for `ib1`. The `smadmin` command has the logic to place `opensm` on the appropriate rack leader controller.

1. From the system admin controller (admin node), to start fabric management on the `ib0` fabric, perform the following:

```
admin:~ # smadmin -f ib0 -u
Running start of ib0
opensm is stopped
Starting opensm on rllead
opensm start [ OK ]
smagent-rack: opensm configuration rllead: opensmd started on fabric ib0
Started opensm for fabric ib0 on rllead
```

2. From the admin node, to start fabric management on the `ib1` fabric, perform the following:

```
admin:~ # smadmin -f ib1 -u
Running start of ib1
Another fabric has opensm (pid 1253) running...
smadmin notice : Another opensm is already running on r1lead
Proceeding to next rack lead opensm is stopped Starting opensm on r2lead opensm start [ OK ]
smagent-rack: opensm configuration r2lead: opensmd started on fabric ib1
Started opensm for fabric ib1 on r2lead
```

Note: The output for the command looks somewhat different because fabric `ib0` is already running and the fabric management software detects this.

If a fabric fails to start, you will see output similar to the following:

```
Running start on r1lead
smadmin: smadmin error : Invalid configuration on r1lead
- Re run /opt/sgi/sbin/smconfig for r1lead
```

To fix this, run commands similar to the following:

```
# smadmin -f ib0 -c          (clear the fabric)
# smconfig -f ib0 -e dor     (reconfigure ib0, for instance)
# smadin -f ib0 -u          (start up the fabric ib0, for instance)
```

3. If both fabric managers started ok, you should be able to ping various `-ib0` and `-ib1` host names in your system (use the `ifconfig(8)` command to get the IP address). From one of the rack leader controllers, ping the `service0 ib0` interface, as follows:

```
r1lead# ping -c 1 10.148.0.67
PING 10.148.0.67 (10.148.0.67) 56(84) bytes of data.
64 bytes from 10.148.0.67: icmp_seq=1 ttl=64 time=0.013 ms

--- 10.148.0.67 ping statistics ---
1 packets transmitted, 1 received, 0% packet loss, time 0ms
rtt min/avg/max/mdev = 0.013/0.013/0.013/0.000 ms
```

If you are not able to ping a system node at this point, it is most likely a cabling issue.

4. To stop the fabric management software on a fabric, perform the following:

```
admin:~ # smadmin -f ib0 -d
Running stop of ib0
opensm is running with pid of 1253...
.....
opensm shutdown [ OK ]
smagent-rack: opensm configuration r1lead: opensmd stopped on fabric ib0
```

5. The fabric manager for each fabric runs on a different rack leader controller node. There is one MASTER node and no standby. From the admin node, to find the MASTER node, perform the following:

```
admin:~ # smadmin -f ib0 -m
smagent-rack: opensm configuration (from r1lead): opensmd master for ib0 is r1lead
```

6. To determine the status of the fabric management software running on your system, perform the following:

```
admin:~ # smadmin -f ib0 -s
Running status of ib0 on r1lead
opensm is running with pid of 30761...
Running status of ib0 on r2lead
Another fabric has opensm (pid 30263) running...
Running status of ib0 on r3lead
opensm is stopped
Running status of ib0 on r4lead
opensm is stopped.
```

Procedure 4-3 Troubleshooting the InfiniBand Fabric

If the fabric management software dies or exits incorrectly, a state may exist that will prevent it from being re-started on that fabric until a cleanup of the fabric management database is performed, as follows:

1. Perform this set of commands from the system admin controller (admin node):

```
admin:~ # /opt/sgi/sbin/smadmin -f ib0 -d
admin:~ # /opt/sgi/sbin/smadmin -f ib0 -c
```

```
admin:~ # /opt/sgi/sbin/smadmin -f ib0 -u
```

2. Repeat for `ib1` fabric if necessary.

For hypercube topology, the OpenSM software is resilient in the following situations:

- compute blade failures / reboots
- IB switch cable pull-outs / and reseating
- IB switch failures / reboots

InfiniBand Fabric Management Configuration and Operation Overview

Each subnet manager (SM) performs a light sweep of the fabric it is managing, every 10 seconds by default. The time interval by setting is in the `SWEEP` variable in the `opensm-ib0.conf` and `opensm-ib1.conf` configuration files located in the `/etc/ofa` directory on the rack leader node.

Note: SGI highly recommends that you do **NOT** change this variable.

If an SM detects a change in the fabric during a light sweep, such as, the addition or deletion of a node, it performs a *heavy* sweep. The heavy sweep actually changes the fabric configuration to reflect the current state of the system.

A sample `opensm-ibx.conf` configuration file is, as follows:

Example 4-8 `opensm-ib0.conf` and `opensm-ib1.conf` Configuration Files

```
# DEBUG mode
# This option specifies a debug option.
# These options are not normally needed.
# The number following -d selects the debug
# option to enable as follows:
# OPT   Description
# ---   -----
# 0    - Ignore other SM nodes.
# 1    - Force single threaded dispatching.
# 2    - Force log flushing after each log message.
# 3    - Disable multicast support.
# 4    - Put OpenSM in memory tracking mode.
```

4: System Fabric Management

```
# 10.. Put OpenSM in testability mode.
# none, no debug options are enabled.
DEBUG=none

# LMC
# This option specifies the subnet's LMC value.
# The number of LIDs assigned to each port is 2^LMC.
# The LMC value must be in the range 0-7.
# LMC values > 0 allow multiple paths between ports.
# LMC values > 0 should only be used if the subnet
# topology actually provides multiple paths between
# ports, i.e. multiple interconnects between switches.
# OpenSM defaults to LMC = 0, which allows
# one path between any two ports.
LMC=0

# MAXSMPS
# This option specifies the number of VL15 SMP MADs
# allowed on the wire at any one time.
# Specifying -maxsmpls 0 allows unlimited outstanding SMPs.
# Without -maxsmpls, OpenSM defaults to a maximum of
# one outstanding SMP.
MAXSMPS=0

# REASSIGN_LIDS
# This option causes OpenSM to reassign LIDs to all
# end nodes. Specifying "REASSIGN_LIDS=yes" on a running subnet
# may disrupt subnet traffic.
# With "REASSIGN_LIDS=no", OpenSM attempts to preserve existing
# LID assignments resolving multiple use of same LID.
REASSIGN_LIDS="no"

# SWEEP
# This option specifies the number of seconds between
# subnet sweeps. Specifying SWEEP=0 disables sweeping.
# OpenSM defaults to a sweep interval of 10 seconds.
SWEEP=10

# TIMEOUT
# This option specifies the time in milliseconds
# used for transaction timeouts.
```

```
# Specifying -t 0 disables timeouts.
# Without -t, OpensM defaults to a timeout value of
# 200 milliseconds.
TIMEOUT=200

# OSM_LOG
# This option defines the log to be the given file.
# By default the log goes to /tmp/osm.log.
# For the log to go to standard output use OSM_LOG=stdout.
OSM_LOG=/var/log/osm-ib0.log

# VERBOSE
# This option increases the log verbosity level.
# The "-v" option may be specified multiple times
# to further increase the verbosity level.
# "-V" option sets the maximum verbosity level and
# forces log flushing.
# The "-V" is equivalent to "-vf 0xFF -d 2".
VERBOSE="none"

# ROUTING_ENGINE
# This option chooses the routing engine instead of
# the Min Hop algorithm which is default.
# Valid routing engines are :-
#     Min Hop, dor, updn, file, ftree
# To switch to different routing engine set the engine
# name in ROUTING_ENGINE (i.e. ROUTING_ENGINE=dor).
# For Min Hop use ROUTING_ENGINE="none" or ROUTING_ENGINE=
ROUTING_ENGINE="dor"

# GUID_FILE
# This option only allowed when UPDN algorithm is activated
# It specifies the guid list file from which to fetch the guid list
# The file contain in each line only one valid guid
GUID_FILE="none"

# This option specifies the local port GUID value
# with which OpensM should bind. OpensM may be
# bound to 1 port at a time.
# If GUID given is 0, opensmd use PORT_NUM parameter.
# Without -g (GUID="none"), OpensM tries to use the default port.
```

4: System Fabric Management

```
# example GUID="0x0005ad00000517c9"
GUID="none"

# OSM_HOSTS
# The list of all SM's IP addresses in InfiniBand subnet
# Used to handover mechanism
# example OSM_HOSTS="128.162.246.221 128.162.246.42"
OSM_HOSTS="none"

# OSM_CACHE_DIR
OSM_CACHE_DIR="/var/cache/osm/ib0"

# CACHE_OPTIONS
# Cache the given command line options into the file
# /var/cache/osm/opensm-ib0.opts for use next invocation
# The cache directory can be changed by the environment
# variable OSM_CACHE_DIR
# Set to '--cache-options' or '-c' in order to enable
CACHE_OPTIONS="-c"

# HONORE_GUID2LID
# This option forces OpenSM to honor the guid2lid file,
# when it comes out of Standby state, if such file exists
# under OSM_CACHE_DIR, and is valid.
# Set to '--honor_guid2lid' or '-x' to enable.
# By default this is FALSE. Will be set automatically to '--honor_guid2lid'
# if OSM_HOSTS includes list of more then one IP addresses.
HONORE_GUID2LID="none"

# RCP
# This option used by SLDD daemon for handover mechanism
# to copy local cache file to remote computer
RCP=/usr/bin/scp

# RSH
# This option used by SLDD daemon for handover mechanism
# to execute commands on remote computer
RSH=/usr/bin/ssh

# RESCAN_TIME
# This option used by SLDD daemon for handover mechanism
```

```
# Time between sweep of sldd daemon in seconds
RESCAN_TIME=60

# PORT_NUM
# This option defines HCA's port number which OpenSM should bind
PORT_NUM=1

# ONBOOT
# To start OpenSM automatically set ONBOOT=yes
ONBOOT=yes

# MULTI_FABRIC
# Allow multiple fabrics (and copies of OpenSM) on the same SM host
MULTI_FABRIC=yes
```

Each fabric is addressed by a global unique identifier (GUID) and unique HCA port (see Figure 4-3 on page 204). Each fabric has a unique GUID set in its respective configuration file.

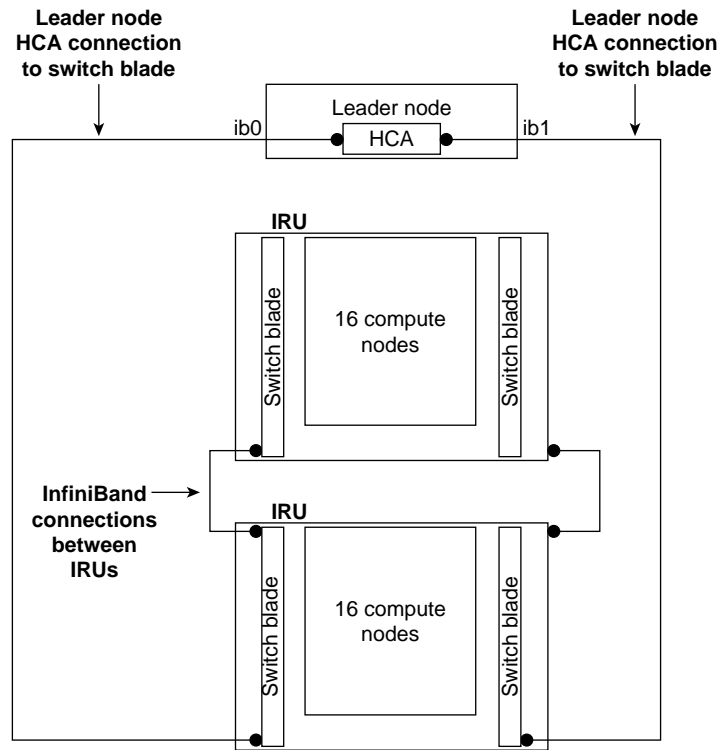

Figure 4-3 Two InfiniBand Fabrics in a System with Two IRUs

Network Topology

For SGI Altix ICE systems with a hypercube topology, SGI requires `ROUTING_ENGINE="dor"` as the default variable (dimension order routing algorithm).

The dimension order routing algorithm is based on the min hop algorithm and so uses shortest paths. Instead of spreading traffic out across different paths with the same shortest distance, it chooses among the available shortest paths based on an ordering of dimensions.

For SGI Altix ICE systems with a fat-tree topology, SGI requires `ROUTING_ENGINE="updn"` as the default variable. Unicast routing algorithm (UPDN) is also based on the minimum hops to each node, but it is constrained to ranking rules.

For more information on routing variables, see the `opensm(8)` man page.

Hypercube network topology is well suited for smaller node count MPI jobs or jobs that have communication patterns that are not sensitive to bisection bandwidth. Fat-tree network topology is well suited for large node count MPI jobs that are sensitive to bi-section bandwidth.

As stated above, there are two `opensm` daemons, one for each fabric, `opensmd-ib0` and `opensmd-ib1`, respectively. They are controlled by the `init.d` scripts. Each `init.d` script has a separate configuration file for each fabric, `opensm-ib0` and `opensm-ib1`, respectively.

You can use the `sminfo` file to show the GUID of the SM master.

Configuring the InfiniBand Fat-tree Network Topology

This section describes how to configure InfiniBand fat-tree network topology.

Procedure 4-4 Configuring InfiniBand Fat-tree Network Topology

To configure the InfiniBand fat-tree network topology on an SGI Altix ICE 8200 series system, perform the following steps:

1. Create the following files on the system admin controller (admin node):

```
/opt/sgi/var/smadmin/ext_switch-ib0
/opt/sgi/var/smadmin/ext_switch-ib1
```

2. With your favorite text editor, specify the external switches on the `ib0` and `ib1` fabrics and their model names in colon-separated lists. For example, for the `/opt/sgi/var/smadmin/ext_switch-ib0` file add two entries, one for each external switch and its model name, as follows:

```
service52020:ISR2012
```

```
service51020:ISR2012
```

Perform this step for the `/opt/sgi/var/smadmin/ext_switch-ib1` file.

3. From the admin node, run the following command:

```
# smconfig -f ib0 -e updn -a /opt/sgi/var/smadmin/ext_switch-ib0
```

4. From the admin node, run the following command:

```
# smadmin -f ib0 -u
```

Repeat these two steps for the `ib1` fabric

- From the admin node, run the following command:

```
# smconfig -f ib1 -e updn -a /opt/sgi/var/smadmin/ext_switch-ib1
```

- From the admin node, run the following command:

```
# smadmin -f ib1 -u
```

InfiniBand Fabric Failover Mechanism

Each subnet manager (SM) has a failover mechanism. If the master SM fails, the standby SM takes over operation of the fabric. This failover operation is performed automatically by the `opensm` software. Typically, `rack1` is the MASTER for the `ib0` fabric and `rack2` has the MASTER for the `ib1` fabric, as shown in Figure 4-4 on page 206.

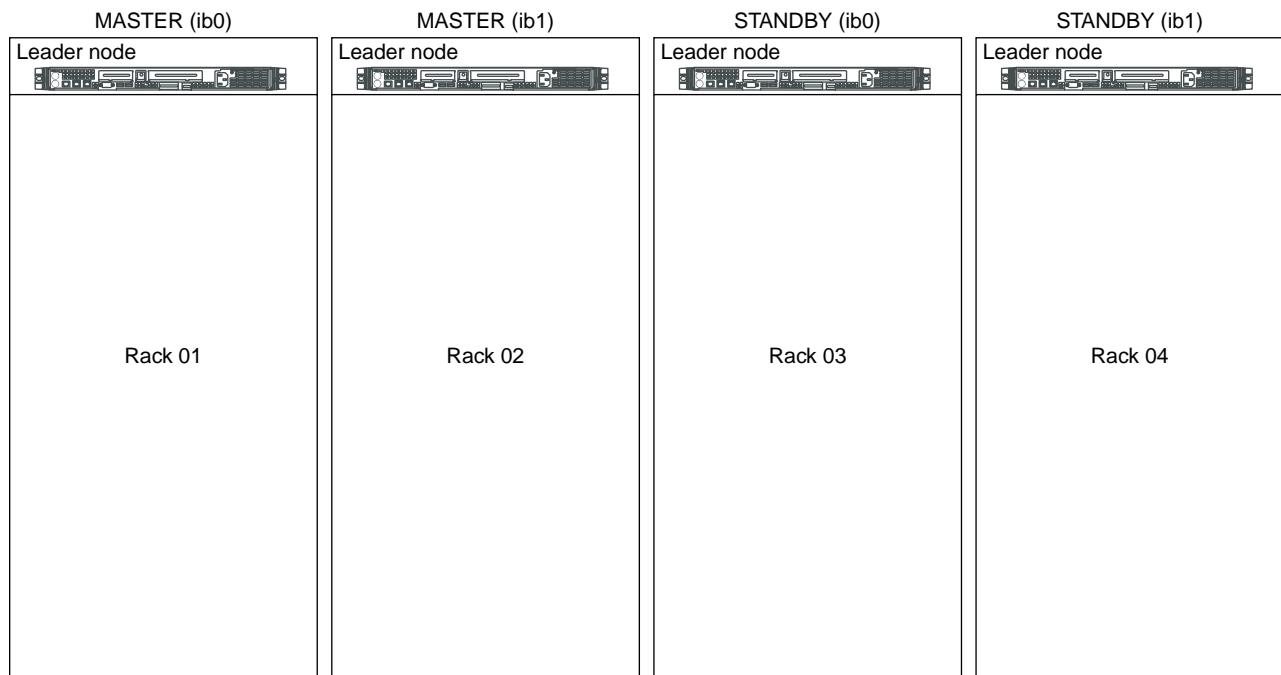

Figure 4-4 `opensm` Software Failover

Note: A minimum of two racks is required for the failover mechanism to be enabled on your SGI Altix ICE system. Tempo software currently does **not** support a mixed MASTER/STANDBY model. This means that you must either configure both InfiniBand planes for MASTER/STANDBY or both without it. When switching between MASTER/STANDBY and none MASTER/STANDBY mode, either direction, you always need to first stop the InfiniBand fabrics. Then, you can reconfigure it and start the InfiniBand fabric again.

The following procedure describes how to setup the failover mechanism.

Procedure 4-5 Enabling the InfiniBand Failover Mechanism

To enable the InfiniBand failover mechanism, perform the following steps:

1. Down the fabric (failover not running), as follows:

```
sys-admin:~ # smadmin -f ib0 -d
sys-admin:~ # smadmin -f ib1 -d
```

2. Configure the ib0 fabric, as follows:

```
# smconfig -f ib0 -e dor -m r1lead -s r2lead
smconfig: smconfig notice : Using dor routing engine
Configuring r1lead as MASTER for ib0 Configuring r2lead as STANDBY for ib0
```

3. Configure the ib1 fabric, as follows:

```
# smconfig -f ib1 -e dor -m r2lead -s r1lead
smconfig: smconfig notice : Using dor routing engine
Configuring r2lead as MASTER for ib1 Configuring r1lead as STANDBY for ib
```

4. Start the ib0 fabric, as follows:

```
sys-admin:~ # smadmin -f ib0 -u
Running start of ib0
Starting master SM for ib0
Enabling opensm for fabric ib0 on r1lead
opensm start [ OK ]
smagent-rack: opensm configuration r1lead: opensmd started on fabric ib0
Started opensm for fabric ib0 on r1lead Starting standby SM for ib0
Enabling opensm for fabric ib0 on r2lead
opensm start [ OK ]
```

```
smagent-rack: opensm configuration r2lead: opensmd started on fabric ib0
Started opensm for fabric ib0 on r2lead
```

5. Start the ib1 fabric, as follows:

```
sys-admin:~ # smadmin -f ib1 -u
Running start of ib1
Starting master SM for ib1
Enabling opensm for fabric ib1 on r2lead
opensm start [ OK ]
smagent-rack: opensm configuration r2lead: opensmd started on fabric ib1
Started opensm for fabric ib1 on r2lead
Starting standby SM for ib1
Enabling opensm for fabric ib1 on r1lead
opensm start [ OK ]
smagent-rack: opensm configuration r1lead: opensmd started on fabric ib1
Started opensm for fabric ib1 on r1lead
```

6. Check the status of the InfiniBand host channel adapters (HCA) on the r1lead leader node, as follows:

```
sys-admin:~ # ssh r1lead ibstatus
Infiniband device 'mthca0' port 1 status:
    default gid:    fec0:0000:0000:0000:0008:f104:0398:7da9
    base lid:       0x1
    sm lid:         0x1
    state:          4: ACTIVE
    phys state:     5: LinkUp
    rate:           20 Gb/sec (4X DDR)

Infiniband device 'mthca0' port 2 status:
    default gid:    fec0:0000:0000:0001:0008:f104:0398:7daa
    base lid:       0x8
    sm lid:         0x1
    state:          4: ACTIVE
    phys state:     5: LinkUp
    rate:           20 Gb/sec (4X DDR)
```

7. Check the status of the InfiniBand HCA on the r2lead leader node, as follows:

```
sys-admin:~ # ssh r2lead ibstatus
Infiniband device 'mthca0' port 1 status:
```

```

default gid:    fec0:0000:0000:0000:0008:f104:0398:7d25
base lid:      0x7
sm lid:        0x1
state:         4: ACTIVE
phys state:    5: LinkUp
rate:          20 Gb/sec (4X DDR)

```

Infiniband device 'mthca0' port 2 status:

```

default gid:    fec0:0000:0000:0001:0008:f104:0398:7d26
base lid:      0x1
sm lid:        0x1
state:         4: ACTIVE
phys state:    5: LinkUp
rate:          20 Gb/sec (4X DDR)

```

8. You can check the process ID (PID) on the r1lead node, the master process will have -p15, as follows:

```

sys-admin:~ # ssh r1lead ps -ef |grep open
root      25318    1  0 11:22 ?          00:00:00 /usr/sbin/opensm -f /var/log/opensm-ib0.log -R dor -g 0x

```

9. You can check the process ID (PID) on the r2lead node, the standby process will have -p0, as follows:

```

sys-admin:~ # ssh r2lead ps -ef |grep open
root      21724    1  0 11:22 ?          00:00:00 /usr/sbin/opensm -f /var/log/opensm-ib0.log -R dor -g 0x

```

To make sure failover is working, perform the following:

1. To verify failover and see what it looks like, use the kill command to kill the master process for ib0 on r1lead, as follows:

```

sys-admin:~ # ssh r1lead kill 25318

```

2. On the the r2lead leader node, verify that it is now the master node, as follows:

```

sys-admin:~ # ssh r2lead tail /var/log/opensm-ib0.log
Nov 07 11:33:45 928093 [43806940] 0x80 -> Entering MASTER state

```

Note that ib0 has failed over from r1lead to r2lead so the log file is on r2lead and it is called opensm-ib0.log.

3. You can now restart the killed process, The log for master again says Entering MASTER state and the log for the standby again says Entering STANDBY state.

Configuring and Initializing the InfiniBand Fabric Manually

This section describes the changes you need to make to the `/etc/opensm-ib0.conf` or `/etc/opensm-ib1.conf` configuration file to configure opensm software, how to start the `opensmd-ib0` and `opensmd-ib1` daemons, and verify the fabric is operating. For an overview of fabric configuration and management, see "InfiniBand Fabric Management Configuration and Operation Overview" on page 199.

Procedure 4-6 Configuring and Initializing the InfiniBand Fabric Manually

To configure, initialize, and verify the InfiniBand fabric, perform the following steps:

1. From the admin node, connect to the leader node or rack 1, as follows:

```
# ssh r1lead
```

Note: Before you attempting to initialize the InfiniBand fabric, make sure all compute nodes are booted and operational.

2. From the admin node, determine and record the IP addresses of the leader nodes, as follows:

```
# ping -c 1 r1lead
PING r1lead.ice.americas.sgi.com (172.16.0.2) 56(84) bytes of data.
64 bytes from r1lead.ice.americas.sgi.com (172.16.0.2): icmp_seq=1 ttl=64 time=0.127 ms

--- r1lead.ice.americas.sgi.com ping statistics ---
1 packets transmitted, 1 received, 0% packet loss, time 0ms
rtt min/avg/max/mdev = 0.127/0.127/0.127/0.000 ms
# ping -c 1 r2lead
PING r2lead.ice.americas.sgi.com (172.16.0.3) 56(84) bytes of data.
64 bytes from r2lead.ice.americas.sgi.com (172.16.0.3): icmp_seq=1 ttl=64 time=0.089 ms

--- r2lead.ice.americas.sgi.com ping statistics ---
1 packets transmitted, 1 received, 0% packet loss, time 0ms
rtt min/avg/max/mdev = 0.089/0.089/0.089/0.000 ms
# ping -c 1 r3lead
```

```
PING r3lead.ice.americas.sgi.com (172.16.0.4) 56(84) bytes of data.  
64 bytes from r3lead.ice.americas.sgi.com (172.16.0.4): icmp_seq=1 ttl=64 time=0.129 ms
```

```
--- r3lead.ice.americas.sgi.com ping statistics ---  
1 packets transmitted, 1 received, 0% packet loss, time 0ms  
rtt min/avg/max/mdev = 0.129/0.129/0.129/0.000 ms
```

```
# ping -c 1 r4lead
```

```
PING r4lead.ice.americas.sgi.com (172.16.0.5) 56(84) bytes of data.  
64 bytes from r4lead.ice.americas.sgi.com (172.16.0.5): icmp_seq=1 ttl=64 time=0.136 ms
```

```
--- r4lead.ice.americas.sgi.com ping statistics ---  
1 packets transmitted, 1 received, 0% packet loss, time 0ms  
rtt min/avg/max/mdev = 0.136/0.136/0.136/0.000 ms
```

3. From the leader node, issue an `ibstat` command to determine the Port GUID values, as follows:

```
rllead:/ # ibstat  
CA 'mthca0'  
  CA type: MT23108  
  Number of ports: 2  
  Firmware version: 3.3.3  
  Hardware version: a1  
  Node GUID: 0x0008f1040397b03c  
  System image GUID: 0x0008f1040397b03f  
  Port 1:  
    State: Active  
    Physical state: LinkUp  
    Rate: 10  
    Base lid: 1  
    LMC: 0  
    SM lid: 1  
    Capability mask: 0x02510a6a  
    Port GUID: 0x0008f1040397b03d <---< goes into opensm-ib0.conf  
  Port 2:  
    State: Initializing  
    Physical state: LinkUp  
    Rate: 10  
    Base lid: 0  
    LMC: 0  
    SM lid: 0  
    Capability mask: 0x02510a68
```

Port GUID: 0x0008f1040397b03e <—<< *goes into opensm-ib1.conf*

Note: Get usage information on the `ibstat` command, as follows:

```
r1lead:/ # ibstat --help
Usage: ibstat [-d(ebug) -l(ist_of_cas) -s(hort) -p(ort_list) -V(ersion)] [portnum]
Examples:
    ibstat -l           # list all IB devices
    ibstat mthca0 2 # stat port 2 of 'mthca0'
```

4. From the leader node, change directory to the `/etc`, as follows:

```
r1lead:/ # cd /etc
```

5. Using your favorite editor, open the `opensm-ib0.conf` file and enter the Port GUID: value, in this example, `0x0008f1040397b03d`, as follows:

```
GUID="0x0008f1040397b03d"
```

6. Using your favorite editor, open the `opensm-ib1.conf` file and enter the Port GUID: value, in this example, `0x0008f1040397b03e`, as follows:

```
GUID="0x0008f1040397b03e"
```

7. There are two routing options available based on fabric topology, as follows:

- For fat-tree network topology, use `updn`.
- For hypercube network topology, use `dor`.

For more information, see "Network Topology" on page 204.

For hypercube network topology, set the `ROUTING_ENGINE` variable in both configuration files to `dor` (dimension order routing) , as follows:

```
ROUTING_ENGINE="dor"
```

For fat—tree network topology, set the `ROUTING_ENGINE` variable in both configuration files to `updn` (Unicast routing algorithm) , as follows:

```
ROUTING_ENGINE="updn"
```

8. To initialize the `ib0` fabric, start the `opensmd-ib0` daemon, as follows:

```
# /etc/init.d/opensmd-ib0 start
```

9. To initialize the ib1 fabric, start the opensmd-ib1 daemon, as follows:

```
# /etc/init.d/opensmd-ib1 start
```

10. Use the ibnetdiscover command to verify the fabric, as follows:

```
rllead:/ # ibnetdiscover -l
Switch : 0x08006900000000dc ports 24 devid 0xb924 vendid 0x2c9 "MT47396 Infiniscale-III Mellanox Technologies"
Switch : 0x08006900000000a4 ports 24 devid 0xb924 vendid 0x2c9 "MT47396 Infiniscale-III Mellanox Technologies"
Ca : 0x0030487aa7940000 ports 1 devid 0x6274 vendid 0x2c9 " HCA-1"
Ca : 0x0030487aa78c0000 ports 1 devid 0x6274 vendid 0x2c9 " HCA-1"
Ca : 0x0008f10403988198 ports 2 devid 0x6278 vendid 0x8f1 "service0-ib0 HCA-1"
Ca : 0x0030487aa7840000 ports 1 devid 0x6274 vendid 0x2c9 " HCA-1"
Ca : 0x0030487aa79c0000 ports 1 devid 0x6274 vendid 0x2c9 " HCA-1"
Ca : 0x0030487aa7900000 ports 1 devid 0x6274 vendid 0x2c9 " HCA-1"
Ca : 0x0030487aa7980000 ports 1 devid 0x6274 vendid 0x2c9 " HCA-1"
Ca : 0x0008f104039881a8 ports 2 devid 0x6278 vendid 0x8f1 " HCA-1"
```

Note: Get usage information on the ibnetdiscover command, as follows:

```
rllead:/ # ibnetdiscover --help
Usage: ibnetdiscover [-d(efug)] -e(rr_show) -v(erbose) -s(how) -l(ist) -g(rouping) -H(ca_list) -S(witch_
-V(ersion) -C ca_name -P ca_port -t(imeout) timeout_ms --switch-map switch-map] []
--switch-map specify a switch-map file
```

11. Exit the rack leader controller (leader node) and return to the system admin controller (admin node), you should be good to go now.

Useful Utilities and Diagnostics

The openib-diags package contains useful tools and diagnostic software for Open Fabrics Enterprise Distribution (OFED). This section describes some of these tools. These tools reside on the rack leader controller (leader node) in the /usr/bin directory, as follows:

```
rllead:~ # cd /usr/bin
rllead:/usr/bin # ls ib*
ibaddr          ibcheckstate    ibdiscover.pl    ibnetdiscover    ib_rdma_bw       ibstatus         ...
ibcheckerrors   ibcheckwidth    ibdmchk          ibnlparse        ib_rdma_lat      ibswitches       ...
ibcheckerrs     ibclearcounters ibdmsh           ibnodes          ib_read_bw       ibsysstat        ...
ibchecknet      ibclearerrors   ibdmtr          ibping           ib_read_lat      ibtopodiff       ...
```

ibchecknode	ib_clock_test	ibfindnodesusing.pl	ibportstate	ibroute	ibtracert	...
ibcheckport	ibdiagnet	ibhosts	ibprintca.pl	ib_send_bw	ibv_asyncwatch	...
ibcheckportstate	ibdiagpath	ibis	ibprintswitch.pl	ib_send_lat	ibv_devices	...
ibcheckportwidth	ibdiagui	iblinkinfo.pl	ibqueryerrors.pl	ibstat	ibv_devinfo	

This section covers the following topics:

- "ibstat and ibstatus Commands" on page 214
- "perfquery Command" on page 216
- "ibnetdiscover Command" on page 217
- "ibdiagnet Command" on page 218

ibstat and ibstatus Commands

You can use the `ibstat` command to see the current status of the host channel adapters (HCA) in your InfiniBand fabric including the HCAs on rack leader controllers. The following view is **prior** to starting the fabric management:

```
r1lead:/usr/bin # ibstat
CA 'mthca0'
  CA type: MT25208 (MT23108 compat mode)
  Number of ports: 2
  Firmware version: 4.7.600
  Hardware version: a0
  Node GUID: 0x0008f104039881a8
  System image GUID: 0x0008f104039881ab
  Port 1:
    State: Initializing
    Physical state: LinkUp
    Rate: 20
    Base lid: 0
    LMC: 0
    SM lid: 0
    Capability mask: 0x02510a68
    Port GUID: 0x0008f104039881a9
  Port 2:
    State: Initializing
    Physical state: LinkUp
    Rate: 20
    Base lid: 0
```

```
LMC: 0
SM lid: 0
Capability mask: 0x02510a68
Port GUID: 0x0008f104039881aa
```

The following shows output from the `ibstat` command **after** the fabric management software has been started:

```
rllead:/opt/sgi/sbin # ibstat
CA 'mthca0'
  CA type: MT25208 (MT23108 compat mode)
  Number of ports: 2
  Firmware version: 4.7.600
  Hardware version: a0
  Node GUID: 0x0008f104039881a8
  System image GUID: 0x0008f104039881ab
  Port 1:
    State: Active
    Physical state: LinkUp
    Rate: 20
    Base lid: 1
    LMC: 0
    SM lid: 1
    Capability mask: 0x02510a6a
    Port GUID: 0x0008f104039881a9
  Port 2:
    State: Active
    Physical state: LinkUp
    Rate: 20
    Base lid: 1
    LMC: 0
    SM lid: 1
    Capability mask: 0x02510a6a
    Port GUID: 0x0008f104039881aa
```

You can use the `ibstatus` (less verbose than `ibstat`) command to show the link rate, as follows:

```
rllead:/opt/sgi/sbin # ibstatus
Infiniband device 'mthca0' port 1 status:
  default gid:      fe80:0000:0000:0000:0008:f104:0398:81a9
  base lid:         0x1
```

```
sm lid:      0x1
state:       4: ACTIVE
phys state:  5: LinkUp
rate:        20 Gb/sec (4X DDR)
```

```
Infiniband device 'mthca0' port 2 status:
default gid: fe80:0000:0000:0000:0008:f104:0398:81aa
base lid:    0x1
sm lid:      0x1
state:       4: ACTIVE
phys state:  5: LinkUp
rate:        20 Gb/sec (4X DDR)
```

Note: If link rate is not 20 Gb/sec 4xDDR, there is a physical link problem with your system.

perfquery Command

The `perfquery` command is useful for find errors on a particular or number of HCA's and switch ports. You can also use `perfquery` to reset HCA and switch port counters.

To see a usage statement for the `perfquery` command, perform the following:

```
rllead:/opt/sgi/sbin # perfquery --help
Usage: perfquery [-d(ebug) -G(uid) -a(all_ports) -r(eset_after_read) -C ca_name -P ca_port -R(eset_only)
-t(imeout) timeout_ms -V(ersion) -h(elp)] [<lid|guid> [[port] [reset_mask]]]
```

Examples:

```
perfquery          # read local port's performance counters
perfquery 32 1     # read performance counters from lid 32, port 1
perfquery -e 32 1  # read extended performance counters from lid 32, port 1
perfquery -a 32    # read performance counters from lid 32, all ports
perfquery -r 32 1  # read performance counters and reset
perfquery -e -r 32 1 # read extended performance counters and reset
perfquery -R 0x20 1 # reset performance counters of port 1 only
perfquery -e -R 0x20 1 # reset extended performance counters of port 1 only
perfquery -R -a 32  # reset performance counters of all ports
perfquery -R 32 2 0x0fff # reset only error counters of port 2
perfquery -R 32 2 0xf000 # reset only non-error counters of port 2
```

Some sample output from the `perfquery` command is, as follows:

```

r1lead:/opt/sgi/sbin # perfquery
# Port counters: Lid 1 port 1
PortSelect:.....1
CounterSelect:.....0x0000
SymbolErrors:.....0
LinkRecovers:.....0
LinkDowned:.....0
RcvErrors:.....0
RcvRemotePhysErrors:.....0
RcvSwRelayErrors:.....0
XmtDiscards:.....0
XmtConstraintErrors:.....0
RcvConstraintErrors:.....0
LinkIntegrityErrors:.....0
ExcBufOverrunErrors:.....0
VL15Dropped:.....0
XmtData:.....0
RcvData:.....0
XmtPkts:.....0
RcvPkts:.....0

```

ibnetdiscover Command

The `ibnetdiscover` command allows you discover the IB fabric.

To see a usage statement for the `ibnetdiscover` command, perform the following:

```

r1lead:/opt/sgi/sbin # ibnetdiscover --help
Usage: ibnetdiscover [-d(ebug)] -e(rr_show) -v(erbose) -s(how) -l(ist)
-g(rouping) -H(ca_list) -S(witch_list)
-V(ersion) -C ca_name -P ca_port -t(imeout) timeout_ms
--switch-map switch-map] [<topology-file>]
--switch-map <switch-map> specify a switch-map file

```

Note: Only abbreviated output is shown in the this example.

Some sample output from the `ibnetdiscover` command is, as follows:

```
rllead:/opt/sgi/sbin # ibnetdiscover
#
# Topology file: generated on Tue Jul 17 14:05:20 2007
#
# Max of 3 hops discovered
# Initiated from node 0008f104039881a8 port 0008f104039881a9

vendid=0x2c9
devid=0xb924
sysimgguid=0x8006900000000dd

...

Switch   : 0x08006900000000dc ports 24 devid 0xb924 vendid 0x2c9
"MT47396 Infiniscale-III Mellanox Technologies"
Switch   : 0x08006900000000a4 ports 24 devid 0xb924 vendid 0x2c9
"MT47396 Infiniscale-III Mellanox Technologies"

rllead:/opt/sgi/sbin # ibnetdiscover -H (HCA's)
Ca       : 0x0030487aa7940000 ports 1 devid 0x6274 vendid 0x2c9 "MT25204 InfiniHostLx Mellanox Technologies"
Ca       : 0x0030487aa78c0000 ports 1 devid 0x6274 vendid 0x2c9 "rli0n8-ib0 HCA-1"
Ca       : 0x0008f10403988198 ports 2 devid 0x6278 vendid 0x8f1 " HCA-1"
Ca       : 0x0030487aa7840000 ports 1 devid 0x6274 vendid 0x2c9 "rli0n1-ib0 HCA-1"
Ca       : 0x0030487aa79c0000 ports 1 devid 0x6274 vendid 0x2c9 "rli1n0-ib0 HCA-1"
Ca       : 0x0030487aa7900000 ports 1 devid 0x6274 vendid 0x2c9 "rli1n8-ib0 HCA-1"
Ca       : 0x0030487aa7980000 ports 1 devid 0x6274 vendid 0x2c9 "rli1n1-ib0 HCA-1"
Ca       : 0x0008f104039881a8 ports 2 devid 0x6278 vendid 0x8f1 " HCA-1"
```

=====

ibdiagnet Command

The `ibdiagnet` command is a useful diagnostic tool.

To see a usage statement for the `ibdiagnet` command, perform the following:

```
rllead:/opt/sgi/sbin # ibdiagnet --help
Loading IBDIAGNET from: /usr/lib64/ibdiagnet1.2
NAME
```

ibdiagnet

SYNOPSIS

```
ibdiagnet [-c ] [-v] [-r] [-o ]
          [-t ] [-s ] [-i ] [-p ]
          [-pm] [-pc] [-P <>]
          [-lw <1x|4x|12x>] [-ls <2.5|5|10>]
```

DESCRIPTION

ibdiagnet scans the fabric using directed route packets and extracts all the available information regarding its connectivity and devices.

It then produces the following files in the output directory defined by the -o option (see below):

```
ibdiagnet.lst      - List of all the nodes, ports and links in the fabric
ibdiagnet.fdb     - A dump of the unicast forwarding tables of the fabric
                   switches
ibdiagnet.mcfdb   - A dump of the multicast forwarding tables of the fabric
                   switches
ibdiagnet.masks   - In case of duplicate port/node Guids, these file include
                   the map between masked Guid and real Guids
ibdiagnet.sm      - A dump of all the SM (state and priority) in the fabric
ibdiagnet.pm      - In case -pm option was provided, this file contain a dump
                   of all the nodes PM counters
```

In addition to generating the files above, the discovery phase also checks for duplicate node/port GUIDs in the IB fabric. If such an error is detected, it is displayed on the standard output.

After the discovery phase is completed, directed route packets are sent multiple times (according to the -c option) to detect possible problematic paths on which packets may be lost. Such paths are explored, and a report of the suspected bad links is displayed on the standard output.

After scanning the fabric, if the -r option is provided, a full report of the fabric qualities is displayed.

This report includes:

```
SM report
Number of nodes and systems
Hop-count information:
    maximal hop-count, an example path, and a hop-count histogram
All CA-to-CA paths traced
Credit loop report
mgid-mlid-HCAs matching table
```

Note: In case the IB fabric includes only one CA, then CA-to-CA paths are not

4: System Fabric Management

reported.

Furthermore, if a topology file is provided, ibdiagnet uses the names defined in it for the output reports.

OPTIONS

```
-c                : The minimal number of packets to be sent
                  across each link (default = 10)
-v                : Instructs the tool to run in verbose mode
-r                : Provides a report of the fabric qualities
-o                : Specifies the directory where the output
                  files will be placed (default = /tmp)
-t                : Specifies the topology file name
-s                : Specifies the local system name. Meaningful
                  only if a topology file is specified
-i                : Specifies the index of the device of the port
                  used to connect to the IB fabric (in case of
                  multiple devices on the local system)
-p                : Specifies the local device's port number used
                  to connect to the IB fabric
-pm               : Dumps all pmCounters values into ibdiagnet.pm
-pc               : reset all the fabric links pmCounters
-P <>: If any of the provided pm is greater then its
                  provided value, print it to screen
-lw <1x|4x|12x>  : Specifies the expected link width
-ls <2.5|5|10>   : Specifies the expected link speed

-h|--help        : Prints this help information
-V|--version     : Prints the version of the tool
--vars           : Prints the tool's environment variables and
                  their values
```

ERROR CODES

```
1 - Failed to fully discover the fabric
2 - Failed to parse command line options
3 - Failed to interact with IB fabric
4 - Failed to use local device or local port
5 - Failed to use Topology File
6 - Failed to load required Package
```

Output which shows no errors means the system is operating correctly:

```
rllead:/opt/sgi/sbin # ibdiagnet
Loading IBDIAGNET from: /usr/lib64/ibdiagnet1.2
Loading IBDM from: /usr/lib64/ibdml.2
-W- Topology file is not specified.
    Reports regarding cluster links will use direct routes.
-W- A few ports of local device are up.
    Since port-num was not specified (-p option), port 1 of device 1 will be
    used as the local port.
-I- Discovering the subnet ... 10 nodes (2 Switches & 8 CA-s) discovered.

-I-----
-I- Bad Guids Info
-I-----
-I- No bad Guids were found

-I-----
-I- Links With Logical State = INIT
-I-----
-I- No bad Links (with logical state = INIT) were found

-I-----
-I- PM Counters Info
-I-----
-I- No illegal PM counters values were found

-I-----
-I- Bad Links Info
-I-----
-I- No bad link were found

-I- Done. Run time was 0 seconds.
```

You can use `ibdiagnet` to load the fabric to test it, as follows:

```
rllead:/opt/sgi/sbin # ibdiagnet -c 5000
Loading IBDIAGNET from: /usr/lib64/ibdiagnet1.2
Loading IBDM from: /usr/lib64/ibdml.2
-W- Topology file is not specified.
```

```

    Reports regarding cluster links will use direct routes.
-W- A few ports of local device are up.
    Since port-num was not specified (-p option), port 1 of device 1 will be
    used as the local port.
-I- Discovering the subnet ... 10 nodes (2 Switches & 8 CA-s) discovered.

-I-----
-I- Bad Guids Info
-I-----
-I- No bad Guids were found

-I-----
-I- Links With Logical State = INIT
-I-----
-I- No bad Links (with logical state = INIT) were found

-I-----
-I- PM Counters Info
-I-----
-I- No illegal PM counters values were found

-I-----
-I- Bad Links Info
-I-----
-I- No bad link were found

-I- Done. Run time was 8 seconds.
```

System Maintenance, Monitoring, and Debugging

This chapter describes system monitoring and covers the following topics:

- "Maintenance Procedures" on page 223
- "Node Replacement Procedure for a Cold Spare Admin, Leader, and Service Nodes" on page 226
- "Inventory Verification Tool" on page 236
- "System Monitoring Overview" on page 239
- "System Monitoring Operation" on page 242
- "Monitoring System Metrics with Performance Co-Pilot" on page 245
- "Setting up the Embedded Support Partner" on page 250
- "Troubleshooting" on page 252
- "kdump Utility" on page 256
- "System Firmware" on page 257

Maintenance Procedures

This section describes some common maintenance procedures, as follows:

- "Temporarily Take a Node Offline for Maintenance" on page 223
- "Permanently Replace a Failed Blade" on page 224
- "Permanently Remove a Blade " on page 225
- "Add a New Blade" on page 226

Temporarily Take a Node Offline for Maintenance

This section describes how to temporarily take a node offline for maintenance.

Procedure 5-1 Temporarily Take a Node Offline for Maintenance

To temporarily Take a node offline for maintenance, perform the following steps:

1. Disable the node in the batch scheduler (depends on your batch scheduler).

2. Power off the node, as follows:

```
# cpower --down r1i0n0
```

3. Mark the node offline, as follows:

```
# cadmin --set-admin-status --node r1i0n0 offline
```

4. Perform any maintenance to the blade that needs to be done.

5. Mark the node online, as follows:

```
# cadmin --set-admin-status --node r1i0n0 online
```

6. Power up the node, as follows:

```
# cpower --boot r1i0n0
```

7. Enable the node in the batch scheduler (depends on your batch scheduler).

Permanently Replace a Failed Blade

Note: See your SGI field support person for the physical removal and replacement of SGI Altix ICE compute nodes (blades).

This section describes how to permanently replace a failed blade.

Procedure 5-2 Permanently Replace a Failed Blade

To permanently replace a failed blade (compute node), perform the following steps:

1. Disable the node in the batch scheduler (depends on your batch scheduler).

2. Power off the node, as follows:

```
# cpower --down r1i0n0
```

3. Mark the node offline, as follows:

```
# cadmin --set-admin-status --node r1i0n0 offline
```

4. Physically remove and replace the failed blade.
5. In the Tempo 1.3 release, it is not necessary to run `discover-rack` when a blade is replaced. This is handled by `blademon` daemon. See "Discovering Compute Nodes" on page 76, for more information.
6. Set the node to boot your desired compute image (see `cimage --list-images` and "cimage Command" on page 141 for your options), as follows:

```
# cimage --set mycomputeimage mykernel r1i0n0
```

7. Power up the node, as follows:

```
# cpower --boot r1i0n0
```

8. Enable the node in the batch scheduler (depends on your batch scheduler).

Permanently Remove a Blade

This section describes how to permanently remove a blade from your Altix ICE system.

Procedure 5-3 Permanently Remove a Blade

To permanently remove a blade from your system, perform the following steps:

1. Disable the node in the batch scheduler (depends on your batch scheduler).
2. Power off the node, as follows:

```
# cpower --down r1i0n0
```

3. Mark the node offline, as follows:

```
# cadmin --set-admin-status --node r1i0n0 offline
```

4. Physically remove the failed blade.
5. In the Tempo 1.3 release, it is not necessary to run `discover-rack` when a blade is replaced. This is handled by `blademon` daemon. See "Discovering Compute Nodes" on page 76, for more information.

Add a New Blade

This section describes how to add a new blade to an Altix ICE system.

Procedure 5-4 Add a New Blade

To add a new blade to your system, perform the following steps:

1. Physically insert the new blade
2. As of the Tempo 1.3 release, it is not necessary to run `discover-rack` when a blade is replaced. This is handled by `blademon` daemon. See "Discovering Compute Nodes" on page 76, for more information.
3. Set the node to boot your desired compute image (see `cimage --list-images` and "cimage Command" on page 141 for your options), as follows:

```
# cimage --set mycomputeimage mykernel r1i0n0
```

4. Power up the node, as follows:

```
# cpower --boot r1i0n0
```

5. Enable the node in the batch scheduler (depends on your batch scheduler).

Node Replacement Procedure for a Cold Spare Admin, Leader, and Service Nodes

This section describe how to install and configure a spare admin, leader, or managed service node. The cold spare can be a shelf spare or a factory-installed cold spare that ships with your system. For more information on cold spare requirements and tools needed to do this procedure, see "Cold Spare Admin or Leader Node Availability" on page 227.

It covers the following topics:

- "Cold Spare Admin or Leader Node Availability" on page 227
- "Identify the Failed Unit and Unplug all Cables" on page 228
- "Migrating to a Cold Spare: Importing the Disk Volumes" on page 232
- "Migrating to a Cold Spare: Booting for the First Time on the Migrated Node" on page 234

Note: When ordering shelf spare systems from SGI, it is important to order spare nodes appropriate to or in conjunction with your SGI Altix ICE system. This is because the Altix ICE serial number is programmed into the admin node itself. If you try to migrate the admin node to a shelf spare system that does not have the correct Altix ICE system serial number programmed into it, parts of Tempo software may not work correctly. In particular, the Embedded Support Partner (ESP) software will fail to start if the system serial number does not match the number that was previously in use.

Depending on the system ordered, your SGI Altix ICE system should be mounted in an SGI rack or racks. The system admin controller (admin node) and rack leader controller (leader node) are generally installed within (or in some cases on top of) the system rack. For an example, see Figure 1-1 on page 2. The replacement of a failed admin node or leader node is accomplished in four basic steps:

- Identify the failed unit and disconnect system and power cables.
- Transfer the disk drives from the failed server into the cold spare unit.
- Connect the applicable cables to the cold spare server.
- Power-up the new server and restart the ICE system.

For detailed procedures on installing a cold spare, see sections "Identify the Failed Unit and Unplug all Cables" on page 228, "Transfer Disks from Existing Server to the Cold Spare" on page 232, "Migrating to a Cold Spare: Importing the Disk Volumes" on page 232 and "Migrating to a Cold Spare: Booting for the First Time on the Migrated Node" on page 234.

Note: If you are using multiple root slots (making use of cascading dual-boot as described in "Cascading Dual-Boot" on page 117) the procedures described in this section will have to be repeated for each slot.

Cold Spare Admin or Leader Node Availability

A cold spare node is like an existing admin or leader node, but it sits on a shelf or is a factory preinstalled node to be used in an emergency.

If the admin or leader node should fail, the cold spare can be swapped in to position to take over the duties of the failed node.

If you wish to make use of cold spare nodes, SGI suggests that you have both an admin node and a leader node on the shelf as available spares. Some of the reasons to have two separate nodes instead of one are (not an exhaustive list), as follows:

- The BIOS settings of an admin and leader node are different. For example, an admin node does not PXE boot by default. However, a leader node must PXE boot each boot. This means the boot order is different for each type.
- The BMC of a leader node is set up to use DHCP by default. An admin node may not be set up this way.
- Given the examples cited about, if you try to use a shelf-spare admin node as a leader, the leader will not be properly discovered.

Shelf Spare Hardware Limitations

Currently, the hardware replacement procedure described in this section only supports Altix `ice-csn` nodes, that is, admin controller and rack leader controller nodes and managed service nodes.

Tools Required

You will need a Video Graphics Array (VGA) screen and a keyboard to perform this procedure. This is because you need to interact with the LSI BIOS tool to import the root volumes. You cannot do this from an Intelligent Platform Management Interface (IPMI) serial console session because of the following:

- For leader nodes, the cluster does not know the MAC addresses of the replacement BMC so there is no way for the cluster to connect to it until the migration script is run.
- The LSI BIOS tool requires the use of `Alt` characters which often do not transfer through the serial console properly.

Identify the Failed Unit and Unplug all Cables

If you have already identified the failed admin node or leader node, proceed with disconnecting the cables from the failed unit. The front panel lights on the server can indicate if the unit has failed and give you information on why, see Figure 5-1 on page 229.

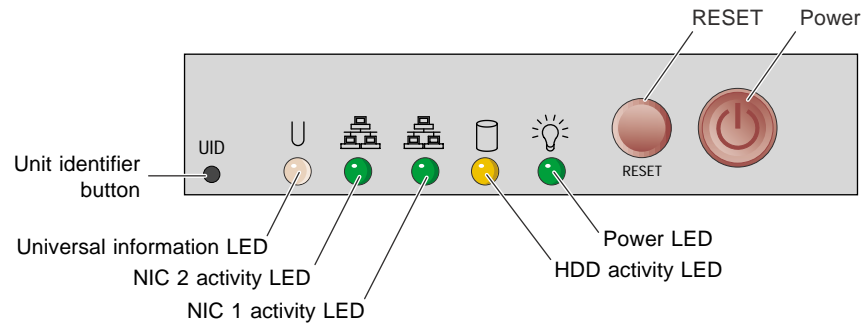

Figure 5-1 Admin/RLC Server Front Panel Controls and Indicator LEDs

The universal information LED (left side of the panel) shows two types of failure that can bring the server down. This multi-color LED blinks red quickly to indicate a fan failure and blinks red slowly for a power failure. A continuous solid red LED indicates a CPU is overheating.

If the unit's power supply has failed or been disconnected, the power LED (far right) will be dark. Check both ends of the power cable for a firm connection prior to switching over to the cold spare.

If you find that an admin node or leader node has failed and you need to replace it with a cold spare system, this section describes what to do in terms of the physical hardware.

Admin nodes are the only node type that store the system-wide serial number. Therefore, if you use a shelf spare leader node as an admin node, ESP will fail to start properly due to the system serial number mismatch and much of the logging and monitoring infrastructure will fail to function. The admin node shelf spares must be ordered from the factory as an admin node shelf spare so that the proper serial number can be stored within.

Procedure 5-5 Replacing a Node with a Cold Spare: Installing the Hardware

To replace an admin node or leader node that has failed, perform the following steps:

1. Power down the failed node (if possible).
2. Disconnect both power cables, see Figure 5-2 on page 231 for server connection locations.

3. Remove the two system disks from the failed node and set them aside for later reinstallation.
4. Unplug the Ethernet cable used for system management (be sure to note the plug number. Label the cables to avoid confusing them. It is important that they stay in the same jacks in the new node). See the example drawing in Figure 1-4 on page 6. This connection is vital to proper system management and communication.
The Ethernet cable must be connected to the same plug on the cold spare unit.
5. If the unit has a system console attached, remove the keyboard, mouse, and video cables.
6. Remove the system from the rack.
7. Install the shelf spare system into the rack.
8. Install the system disks you set aside in step 3 (from the system you are replacing).
9. Connect the Ethernet cables in the same way they were connected to the replaced node.
10. Connect AC power.
11. Connect a keyboard and VGA monitor (and mouse if you like).
12. Do **NOT** power up the system just yet. Proceed to "Migrating to a Cold Spare: Importing the Disk Volumes" on page 232.

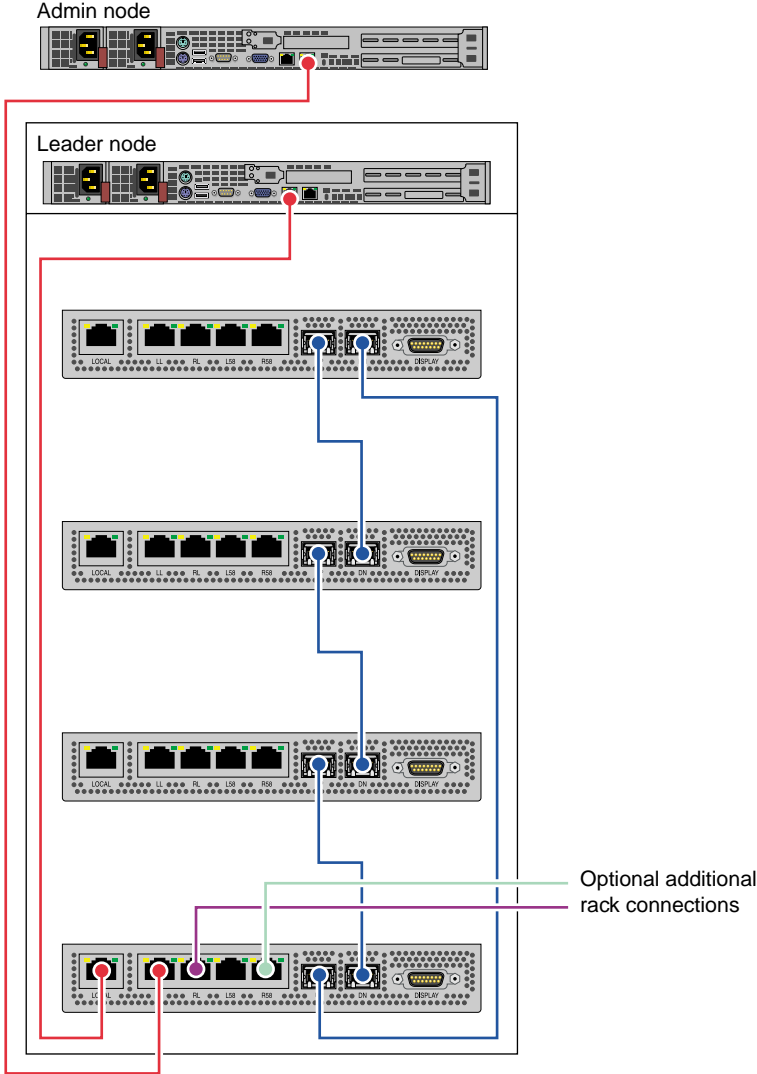

Figure 5-2 Admin/Leader to CMC Cable Examples

Transfer Disks from Existing Server to the Cold Spare

Note: The factory-installed cold spare does NOT ship with disks so you need to transfer existing disks and PCI cards from the existing server to the cold spare before mounting the spare rack.

Transfer disks from the existing server to the cold spare as shown in Figure 5-3 on page 232.

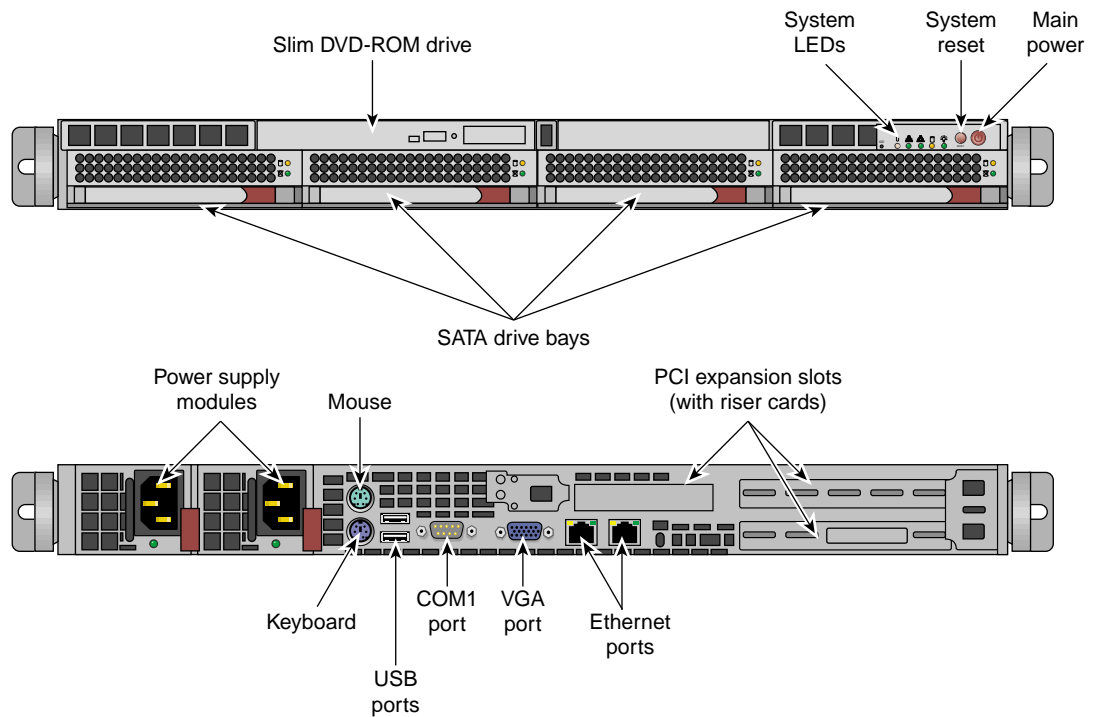

Figure 5-3 Admin/Leader Server Front Features and Rear Connector Locations

Migrating to a Cold Spare: Importing the Disk Volumes

This section describes how to import the disk volumes into the new node installed in "Identify the Failed Unit and Unplug all Cables" on page 228.

Note: This section does not apply to SGI Altix XE250 systems with MegaRAID SAS/SATA storage hardware.

Procedure 5-6 Migrating to a Shelf Spare: Importing the Disk Volumes

To import the disk volumes into the new node, perform the following steps:

1. At this time, you can power up the system using the power button.
2. Watch the VGA screen output.
3. When you see the LSI BIOS tool come up up, enter `Ctrl-C`. This will instruct the LSI BIOS tool to enter the configuration utility.
4. A screen appears listing the LSI controllers in the system. Normally, there is just one. Hit the `Enter` key to proceed.
5. Choose **RAID Properties**.
6. It is important to note that the controller supports only two RAIDs at a time. Therefore, if the system had two volumes at a time in the past, one or more volumes may appear empty now. It is important to use the utility to delete these empty volumes representing disks that are no longer installed before proceeding. Otherwise, if the tool sees more than one volume, activating volumes will not work.
7. Enter `Alt-N` to browse the list of volumes. Delete the empty ones as described in the step, above. Eventually, you will encounter an inactive volume. This inactive volume represents the disks you migrated from the failed node to this node.
8. With the inactive volume selected, choose **Manage Array**.
9. Choose **Activate** and answer `y` to the **activate and exit this menu** choice.
10. At this point, especially if the node has more than one volume, it is important to select the migrated system disk volume as the boot volume. To select the boot volume, choose **SAS Topology**.
11. In **SAS Topology**, you can expand the volumes to see the disks within them if you choose by hitting `Enter` on volumes.
12. Choose the volume that represents your newly imported volume. Highlight it, then enter `Alt-B`.

13. You should see that the volume now has a **Boot** flag associated with it.

Note: If, after you exit the tool, the system does not appear to boot from the disk. You may have selected the wrong volume from which to boot. In that case, reset, re-enter the LSI BIOS Tool, and choose a different volume to be the boot volume.

14. Escape out of the LSI tool and exit.
15. Keep watching the VGA screen! You will have to hit a key at the correct moment in the next section. Go to "Migrating to a Cold Spare: Booting for the First Time on the Migrated Node" on page 234.

Migrating to a Cold Spare: Booting for the First Time on the Migrated Node

This section provides details on booting the system for the first time on the replacement node. These instructions include some special things you need to do with GRUB boot loader to ensure, for this boot only, that the console output goes to the VGA screen. This is important because on leader nodes, there is no way to connect to the BMC with IPMI at this moment to use the IPMI serial console. The `console` command will not work for the leader node until the system is configured as described in this section. The network will not be properly configured until the end of this procedure either.

Procedure 5-7 Migrating to a Cold Spare: Booting for the First Time on the Migrated Node

To boot for the first time on a migrated node, perform the following steps:

1. Ensure that the VGA console is powered on.
2. At this moment, the node is in the process of resetting because you exited the LSI BIOS tool at the end of the procedure, above (see "Migrating to a Cold Spare: Importing the Disk Volumes" on page 232).

Note: After rebooting, drive 1 will resync with drive 0, automatically. Drive 1 will have the RED LED on during this time. This process takes from eight to 48 hours depending on the drive size. During that period, the RAID redundancy is not available but the system will function normally.

On leader nodes, the node will attempt to PXE boot as it comes up. This is normal. The PXE boot will fail and this is normal. On the admin node, no PXE will be attempted. In either case, the system will eventually try to boot from disk.

Note: If it is not booting from disk, the wrong volume may be selected as the boot disk in the LSI BIOS tool. See "Migrating to a Cold Spare: Importing the Disk Volumes" on page 232.

When you see the GRUB boot menu come up, the first boot option will be highlighted by default. This should NOT be the choice starting with Failsafe. As an example, in SGI Tempo 1.4, the highlighted choice should be : **SUSE Linux Enterprise Server 10 SP2**. Enter **e** to edit the boot parameters for this boot only.

3. Arrow down once so that the line starting **kernel** is highlighted.
4. Enter **e** to edit the kernel parameters.
5. Now you need to add `console=tty0` as the final parameter in the list. This ensures that console output goes to the VGA screen for this boot. Enter the space character followed by `console=tty0`. The line should look similar to the following after adding the console parameter (characters wrapped in the front):

```
<hkernel=128M@16M rootflags=prjquota,logbsize=256k console=tty0
```

6. Press the Enter key.
7. Enter **b** to boot the system.

The system will now boot with console output going to the VGA screen.

Networking will fail to start and some error messages will appear.

It is normal to see that the Ethernet devices were renumbered. This will be fixed below.

Eventually the login prompt will appear.

8. Log in as root.
9. The following script fixes the network settings and update the SGI Tempo database for the new network interfaces, as follows:

```
# migrate-to-shelf-spare-node
```

Note: If you have Ethernet cards installed, in addition to the ones that come with the system itself, the script could possibly guess the integrated Ethernet devices incorrectly. This may mean you have to manually configure networking including the `ifcfg-eth-id-*` files in `/etc/sysconfig/network` and the `/etc/udev/rules.d/30-net_persistent_names.rules` file (to number them how you want and ensure integrated Ethernet is `eth0` and `eth1`).

At this time, networking should be operational.

10. Reboot the node and let it boot normally.

Inventory Verification Tool

You can use the SGI Tempo inventory verification tool to query, take snapshots, analyze and compare the node and network inventory of a cluster. Various hardware, network and operating system configuration properties are available and are presented in user-specified formats.

Note: If you are reinstalling the system admin controller (admin node), you may want to make a backup of the cluster configuration snapshot that comes with your system so that you can recover it later. You can find it in the `/opt/sgi/var/ivt` directory on the admin node; it is the earliest snapshot taken. You can use this information with the interconnect verification tool (IVT) to verify that the current system shows the same hardware configuration as when it was shipped. For more information, see "Installing Software on the System Admin Controller" on page 31.

To make an inventory snapshot of an Altix ICE system, use the following command from the system admin controller (admin node).

```
system-admin:~ # ivt -M  
Making a cluster inventory snapshot. Takes a couple of minutes...
```

Each snapshot is assigned a unique number and marked with the date and time it was taken. Use the `ivt --L` command to list active snapshot information, as follows:

```
system-admin:~ # ivt -L  
1 2007-07-13.11:42:47
```

You can query (-Q option), compare (-C option) and analyze (-S option) existing snapshots. A variety of system hardware and configuration properties can be displayed. You can compare two snapshots to see what has changed or analyze a system snapshot for failed nodes and or see network fabric links.

You use the `ivt` command to show general information about your system (note that only a portion of the output of this command is shown below), as follows:

```
system-admin:~ # ivt -S
```

```
Your system has 6 compute blades.
```

```
All 6 blades have the following characteristics:
```

```
  bios_date: 05/29/2007
  cpu_core_count: 8
  cpu_model: Intel(R) Xeon(R) CPU E5345 @ 2.33GHz
  kernel: 2.6.16.46-0.12-smp
  memsize: 2059264
  os_product: SLES
  os_vendor: SUSE
  os_version: 10.1
```

```
The following characteristics have different values for some blades.
```

```
ib0_phys_state (State of InfiniBand ib0 physical link):
  4 blades have ib0_phys_state == LinkUp (rli0n0, rli1n0, rli0n8, ...)
  2 blades have ib0_phys_state == unknown (rli0n1, rli1n1)
Query the value for all blades with:
  ivt -Q -w blades -f 'blade $blade has ib0_phys_state $ib0_phys_state'
```

```
ib0_rate (Rate of InfiniBand ib0 link - Gb/sec):
  2 blades have ib0_rate == unknown (rli0n1, rli1n1)
  4 blades have ib0_rate == 20 (rli0n0, rli1n0, rli0n8, ...)
Query the value for all blades with:
  ivt -Q -w blades -f 'blade $blade has ib0_rate $ib0_rate'
```

```
...
```

```
ib_bios_rev (Revision of InfiniBand BIOS on blade):
  2 blades have ib_bios_rev == unknown (rli0n1, rli1n1)
  4 blades have ib_bios_rev == 1.2.0 (rli0n0, rli1n0, rli0n8, ...)
Query the value for all blades with:
  ivt -Q -w blades -f 'blade $blade has ib_bios_rev $ib_bios_rev'
```

```
image (image provisioned on blade):
    5 blades have image == compute-sles10sp1 (rli0n1, rli1n1, rli1n0, ...)
    1 blades have image == erikj-blade-mksiimage (rli0n0)
Query the value for all blades with:
    ivt -Q -w blades -f 'blade $blade has image $image'

rack_blade_count (number of booted blades in this blades rack):
    2 blades have rack_blade_count == 5 (rli0n1, rli1n1)
    4 blades have rack_blade_count == 4 (rli0n0, rli1n0, rli0n8, ...)
Query the value for all blades with:
    ivt -Q -w blades -f 'blade $blade has rack_blade_count $rack_blade_count'
```

InfiniBand GUID check:

```
Do fabric (ibnetdiscover) and blades (ib stat) have same GUIDs?
ib0 plane: unmatched GUIDs
GUIDs seen on blade ports, missing on fabric: unknown 0030487aa7940000
GUIDs see on fabric, missing on blade ports: 0030487aa7840000 0030487aa7980000
ib1 plane: unmatched GUIDs
GUIDs seen on blade ports, missing on fabric: unknown 0030487aa7950000
GUIDs see on fabric, missing on blade ports: 0030487aa7850000 0030487aa7990000
```

InfiniBand Link state check:

```
Are any IB ports not ACTIVE, not 20 Gb/sec rate or not Up?
```

...

You can use the `ivt -c cpu` command to show an inventory of the system compute blades and the number of CPUs each blade contains, as follows:

```
system-admin:~ # ivt -c cpu
rli0n0 has 8 CPUs
rli0n1 has 8 CPUs
rli0n8 has 8 CPUs
rli1n0 has 8 CPUs
rli1n1 has 8 CPUs
rli1n8 has 8 CPUs
```

You can use the `ivt` tool to determine which compute nodes (blades) are up or down, as follows:

```
system-admin:~ # ivt -Q -w blades -f '$blade $sshstate'
rli0n0 up
rli0n1 down
rli0n8 up
rli1n0 up
rli1n1 down
rli1n8 up
```

You can use the `ivt` tool to determine the GigE Ethernet address for each compute node (blade) , as follows:

```
system-admin:~ # ivt -Q -w blades -f '$blade $gige_ip_addr'
rli0n0 192.168.159.10
rli0n1 192.168.159.11
rli0n8 192.168.159.18
rli1n0 192.168.159.26
rli1n1 192.168.159.27
rli1n8 192.168.159.34
```

For detailed information on how to use the `ivt` tool, see the `ivt(8)` man page or `ivt -h, --help` usage statement.

System Monitoring Overview

Ganglia is a scalable, distributed monitoring system for monitoring system for high-performance computing systems, such as the SGI Altix ICE 8200 system. It displays web browser-based, real-time (on demand) histograms of system metrics, as shown in Figure 5-4 on page 240.



Figure 5-4 Ganglia System Monitor

Detailed information about the Ganglia monitoring system is available at: <http://ganglia.info/>.

SGI Tempo has devised a Ganglia model for the Altix ICE system that makes maximum use of Ganglia's highly scalable architecture: each compute node (blade) presents a single monitoring source sending its statistics to the rack leader controller. Therefore, the rack leader controller receives, at most, data from 64 blades. After collecting the data, the rack leader controller forwards aggregated rack statistics to the system admin controller (admin node). The rack leader controller also sends its own statistics to the system admin controller. The system admin controller presents the meta-aggregator for the entire Altix ICE system. It collects data from all rack leaders and presents the cluster-wide metrics. This model enables SGI to scale-out Ganglia to very large cluster deployments.

The **Node View** as shown in Figure 5-5 on page 242 can aid in system troubleshooting. For every blade in the system, the **Location** field of the **Node View** shows the exact physical location of the blade. This is an extremely useful when trying to locate a blade that is down.

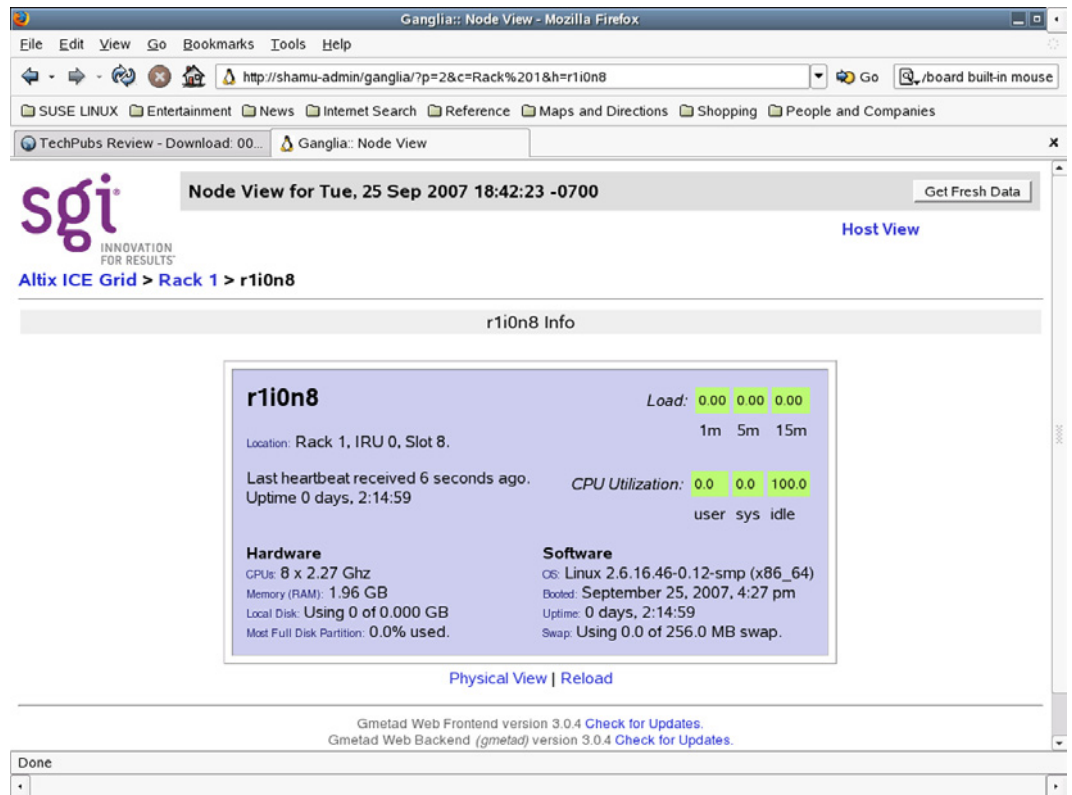

Figure 5-5 Ganglia System Monitoring Node View

System Monitoring Operation

This section describes the operation of the Ganglia system monitor and covers the following topics:

- "Accessing the Ganglia System Monitor" on page 243
- "Monitoring System Metrics" on page 243
- "SEL/Hardware Event Monitoring" on page 243
- "Node Availability Monitoring" on page 244

Accessing the Ganglia System Monitor

To access the Ganglia system monitor, point your browser to the following location:
http://admin_pub_name/ganglia

Monitoring System Metrics

By default, Ganglia monitors standard operating system metrics like CPU load, memory usage. The **Grid Report** view shows an overview of your system, such as the number of CPUs, the number of hosts (compute nodes) that are up or down, service node information, memory usage information, and so on.

The **Last** pull down menu allows you to view performance data on an hourly, daily, weekly, or yearly basis. The **Sorted** pull down menu allows provides an ascending, descending, or by host view of performance data. The **Grid** pull-down menu allows you to see performance data for a particular rack or service node. The **Get Fresh Data** button allows you to see current data performance.

SEL/Hardware Event Monitoring

The system admin controller, rack leader controllers, the service nodes, the chassis management controllers (CMCs) and all the compute nodes (blades) are equipped with a specialized controller, called the Board Management Controller (BMC). This unit provides a broad set of functions as described in the IPMI 2.0 standard. SGI TEMPO software uses the BMCs predominantly for remote power management, remote system configuration, and for gathering critical hardware events.

Currently, critical hardware events are gathered for the following nodes: rack leader controllers (leader nodes), CMCs and compute nodes (blades). These events are logged in the following locations:

- `/var/log/messages` via `syslog`
- `var/log/sel/sel.log`
- Embedded Support Partner (ESP)

Whenever critical hardware event occurs, information is forwarded about the event to all three locations. You can observe a critical hardware event via `syslog`, via `sel.log` or using ESP. Furthermore, administrator-defined actions can be triggered via ESP, for instance sending an e-mail notification to the system administrator. For

more information on ESP, see `esp(5)` man page and the *SGI Embedded Support Partner User Guide*.

All critical hardware events are summarized under the `BMC_CMC` event type. One particular event holds the following useful information:

```
MSG ::= <syslog-prefix> TEMPO:<node> EVENT:<event> APP:<app> Date:<date> VERSION:<version> TEXT <text>
```

The following fields are all of the type string:

<node>	node name, for example, <code>r1i0n5</code>
<event>	<code>BMC_CMC</code>
<app>	<code>SEL-LOGGER</code>
<date>	date / time of the event
<version>	1.0
<text>	Exact copy of the hardware event description from the BMC

After reading the events from the BMCs, the BMC event logs are cleared on the controller to avoid duplicate events.

Node Availability Monitoring

The availability of each node in an SGI Altix ICE system is monitored by a lightweight daemon called `tempohbc`. Each managed service node, rack leader controller (leader node), and compute node runs this daemon and reports its status to the server which monitors it. The server daemon, which runs on the admin node and leader nodes, reports if the client is down after approximately 120 seconds. In this event, a HEARTBEAT Embedded Support Partner (ESP) event is generated. You can observe this event via `syslog` or using ESP. Furthermore, administrator-devined actions can be triggered, for instance sending an e-mail notification to the system administrator. For more information on ESP, see `esp(5)` man page and the *SGI Embedded Support Partner User Guide*.

The HEARTBEAT event contains the following useful information:

```
MSG ::= <syslog-prefix> TEMPO:<node> EVENT:HEARTBEAT APP:TEMPOHBD Date:<date> VERSION:1.0 TEXT <text>
```

The HEARTBEAT event is created when nodes fail or recover, described by the `TEXT` field.

The following fields are all of the type string:

<code><node></code>	node name, for example, <code>r1i0n5</code>
<code><date></code>	date / time of the event
<code><text></code>	Description of event: ' <code>Heartbeat not detected</code> ' ' <code>Heartbeat lost</code> '

Monitoring System Metrics with Performance Co-Pilot

A wealth of system metrics are also available through the Performance Co-Pilot (see *Performance Co-Pilot Linux User's and Administrator's Guide*). The Performance Co-Pilot collection daemon (PMCD) runs on the admin node, managed service nodes, and rack leader nodes. A performance metrics domain agent (PMDA) is running on the rack leader nodes, which collects metrics from the compute nodes.

The new cluster metrics domain contains metrics that were previously available in other PMDAs. The method in which they are collected is different in a Tempo system, in order to minimize load on the compute nodes. The following metrics are available for each compute node in a system by querying the PMCD on their rack leader node:

```

sys-admin:~ # pminfo -h r1lead cluster
cluster.control.suspend_monitoring
cluster.kernel.percpu.cpu.user
cluster.kernel.percpu.cpu.sys
cluster.kernel.percpu.cpu.idle
cluster.kernel.percpu.cpu.intr
cluster.kernel.percpu.cpu.wait.total
cluster.mem.util.free
cluster.mem.util.bufmem
cluster.mem.util.dirty
cluster.mem.util.writeback
cluster.mem.util.mapped
cluster.mem.util.slab
cluster.mem.util.cache_clean
cluster.mem.util.anonpages
cluster.network.interface.in.bytes
cluster.network.interface.in.errors
cluster.network.interface.in.drops
cluster.network.interface.out.bytes
cluster.network.interface.out.errors
cluster.network.interface.out.drops
cluster.network.ib.in.bytes

```

```
cluster.network.ib.in.errors.drop
cluster.network.ib.in.errors.filter
cluster.network.ib.in.errors.local
cluster.network.ib.in.errors.remote
cluster.network.ib.out.bytes
cluster.network.ib.out.errors.drop
cluster.network.ib.out.errors.filter
cluster.network.ib.total.errors.link
cluster.network.ib.total.errors.recover
cluster.network.ib.total.errors.integrity
cluster.network.ib.total.errors.vl15
cluster.network.ib.total.errors.overrun
cluster.network.ib.total.errors.symbol
```

Configuring Compute Blade Metrics

The list of metrics that are monitored by the compute node and are pushed to the PMCD on the leader node is configurable. In some cases, it may be even be desirable to disable metric collection entirely, as follows:

```
# cexec --head --all pmstore cluster.control.suspend_monitoring 1 pmstore -h r1lead cluster.control.suspend_monitoring
```

The default list of metrics that are collected by each compute node contains 41 metrics. There are dozens more available in the `cluster.*` namespace. The default list is stored on each leader node in the `/var/lib/pcp/pmdas/cluster/config` file. Changing this file will allow you to modify the default metric list with rack granularity. To change the list on a single node store a newline-delimited list of metrics to the node's instance of the `cluster.control.metrics` metric.

To see the current metric list for a compute node, perform the following:

```
# pmval -h r1lead -s 1 -i 'r1i1n0' cluster.control.metrics
```

```
metric:    cluster.control.metrics
host:      r1lead
semantics: discrete instantaneous value
units:     none
samples:   1
```

```

                r1i1n0
"cluster.kernel.percpu.cpu.user
cluster.kernel.percpu.cpu.nice
```

```
cluster.kernel.percpu.cpu.sys
cluster.kernel.percpu.cpu.idle
cluster.kernel.percpu.cpu.intr
cluster.kernel.percpu.cpu.wait.total
cluster.mem.util.free
cluster.mem.util.bufmem
cluster.mem.util.dirty
cluster.mem.util.writeback
cluster.mem.util.mapped
cluster.mem.util.slab
cluster.mem.util.cache_clean
cluster.mem.util.anonpages
cluster.infiniband.port.rate
cluster.infiniband.port.in.bytes
cluster.infiniband.port.in.packets
cluster.infiniband.port.in.errors.drop
cluster.infiniband.port.in.errors.filter
cluster.infiniband.port.in.errors.local
cluster.infiniband.port.in.errors.remote
cluster.infiniband.port.out.bytes
cluster.infiniband.port.out.packets
cluster.infiniband.port.out.errors.drop
cluster.infiniband.port.out.errors.filter
cluster.infiniband.port.total.bytes
cluster.infiniband.port.total.packets
cluster.infiniband.port.total.errors.drop
cluster.infiniband.port.total.errors.filter
cluster.infiniband.port.total.errors.link
cluster.infiniband.port.total.errors.recover
cluster.infiniband.port.total.errors.integrity
cluster.infiniband.port.total.errors.vl15
cluster.infiniband.port.total.errors.overrun
cluster.infiniband.port.total.errors.symbol
cluster.network.interface.in.bytes
cluster.network.interface.in.errors
cluster.network.interface.in.drops
cluster.network.interface.out.bytes
cluster.network.interface.out.errors
cluster.network.interface.out.drops
"
```

An example that changes the metric list to only include the CPU metrics for `r1i1n0` is, as follows:

```
# pmstore -h r1lead -i 'r1i1n0' cluster.control.metrics 'cluster.kernel.percpu.cpu.user cluster.kernel.percpu.cpu.nic
cluster.kernel.percpu.cpu.sys cluster.kernel.percpu.cpu.idle cluster.kernel.percpu.cpu.intr cluster.kernel.percpu.cpu
```

Monitoring SDR Metrics

The sensor data repository (SDR) metrics are available through Performance Co-Pilot (see *Performance Co-Pilot Linux User's and Administrator's Guide*). The SDR provides temperature, voltage, and fan speed information for all service nodes, leader nodes, compute nodes, and CMCs. This information is collected from service and compute nodes through their BMC interface, so it is out-of-band and does not impact the performance of the node.

The following metrics are available through the PMCD:

```
sys-admin:~ # pminfo -h r1lead sensor
sensor.value.fan
sensor.value.voltage
sensor.value.temperature
```

Each sensor will have a separate instance within the domain, with the instance of the form:

```
<nodeName>:<nodeType>:<metricName>

nodeName ::= Tempo node names (rXlead, rXiYc, rXiYnZ)
nodeType ::= "service", "cmc", "blade", "leader"
```

For example, to view voltages for the rack leader node, perform the following

```
sys-admin:~ # pminfo -h r1lead -f sensor.value.voltage | grep -E '(^$|^sensor|r1lead)'
```

```
sensor.value.voltage
  inst [0 or "r1lead:leader:CPU1_Vcore"] value 1.3
  inst [1 or "r1lead:leader:CPU2_Vcore"] value 1.3
  inst [2 or "r1lead:leader:3.3V"] value 3.26
  inst [3 or "r1lead:leader:5V"] value 4.9
  inst [4 or "r1lead:leader:12V"] value 11.71
  inst [5 or "r1lead:leader:-12V"] value -12.3
  inst [6 or "r1lead:leader:1.5V"] value 1.47
  inst [7 or "r1lead:leader:5VSB"] value 4.9
```

```
inst [8 or "r1lead:leader:VBAT"] value 3.31
```

For additional examples on how to retrieve values using `pmval(1)` and for using this data in trend analysis using `pmie(1)`, see the appropriate man page and the *Performance Co-Pilot Linux User's and Administrator's Guide*.

Cluster Performance Monitor

You can use the Cluster Performance Monitor to monitor your Altix ICE system. Log into the admin node using the `ssh -X` command. Execute the `pmice` command and the **pmice - Cluster Performance Monitor** appears, as follows:

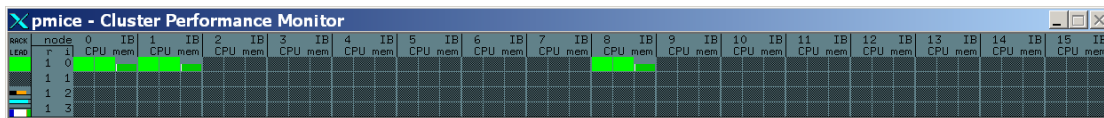

Figure 5-6 pmice- Cluster Performance Monitor

For a usage statement, use the `pmice --h` command, as follows:

```
system-admin:~ # pmice --h
/usr/bin/pmice: illegal option -- -
Info:
Usage: pmice [options] [pmgadgets options]
```

options:

```
-K list Show these CPUs. Comma-separated list
-N list Show these nodes. Comma-separated list
-R list Show these racks. Comma-separated list
-V      Verbose/diagnostic output
```

pmgadgets(1) options:

```
-C          check configuration file and exit
-h host    metrics source is PMCD on host
-n pmnsfile use an alternative PMNS
-t interval sample interval [default 2.0 seconds]
-z         set reporting timezone to local time of metrics source
-Z timezone set reporting timezone
```

```
-zoom factor          make the gadgets bigger by a factor of 1, 2, 3 or 4
-infofont fontname    use fontname for text in info dialogs
-defaultfont fontname use fontname for label gadgets

-display display-string
-geometry geometry-string
-name name-string
-title title-string
-xrm resource
```

Setting up the Embedded Support Partner

The Embedded Support Partner (ESP) is a software suite to monitor events, set up proactive notification, and generate reports on SGI Altix systems. This section describes how to set it up on an SGI Altix ICE system. For detailed information about ESP, see *Embedded Support Partner User Guide*.

Procedure 5-8 Setting up the Embedded Support Partner

To set up ESP on an SGI Altix ICE system, perform the following steps:

1. From the admin node, use the `chkconfig` command to make sure that the state of ESP is on, as follows:

```
sys-admin:~ # chkconfig --list | grep esp
esp          0:on  1:on  2:on  3:on  4:on  5:on  6:on
             sgi-esphttp:    on
             sgi_espd:       on
```

ESP should already be running if its `chkconfig` flag is on. You can interact with ESP using a web interface or the command line (see Chapter 4, “Setting Up the ESP Environment” in the *Embedded Support Partner User Guide*).

2. From the admin node, create the default ESP user account, as follows:

```
system-admin:~ # espsconfig -createadmin
```

3. Enable the hosts that will be allowed to access ESP with the following commands:

```
system-admin:~ # espsconfig -enable ipaddr 127.0.0.0
system-admin:~ # espsconfig -enable ipaddr 127.0.0.1
system-admin:~ # espsconfig -enable ipaddr IP_address_of_client
```

4. From your laptop or PC system, point your browser to `http://mymachine__-admin:5554` and log into ESP.
5. When the ESP login screen appears, login as administrator, use the password partner. After you login, the **System Information** screen appears (see Chapter 2, “Accessing ESP” *Embedded Support Partner User Guide*).
6. Now enter the **Customer Profile** information, as follows:
 - a. **Select ESP Administration** from the menu.
 - b. Click on **Customer Profile** (if not selected by default).
 - c. Fill in the form and then click **Add**.
 - d. Click **Commit**; or **Update** if already filled out.
7. Use ESP to **Examine Inventory**, as follows:
 - a. **Select Reports Hardware Generate Report**.
 - b. **Select Reports Software Generate Report**.
 - c. You can search for individual packages by entering the name in the search box (below the system host name) and then selecting **GO** on the right hand side of the screen. You can also use the down arrow to select a package in this search box.
8. Use ESP to enable or disable **Performance Monitoring**, as follows:
 - a. **Select Configuration** (from the top level menu) and then select **Performance Monitoring**.
 - b. Enable **PMIE**.
 - c. Disable the **PMIE** rule `cpu.util`.
 - d. **Select Commit**.
 - e. **Select Configuration System Monitoring** and enable the service `pmcd`.
 - f. **Select Update and Commit** (this may take a few minutes).
9. Use ESP to examine errors logs, as follows:
 - a. From the top level menus, select **Report Events**.
 - b. Then select **Last 30 days** and **All Classes** before clicking on **Generate Report**.

10. Use ESP to enable or disable **Notification**

Notification of events is handled by `espnotify`. The notification can be of types e-mail, system console, or graphics console. The notifications are enabled or disabled by specific actions. So after configuring the notification action you can enable or disable the notification, as follows:

- a. Select **Configuration Actions** and click **Continue**.
- b. Decide on the notification format and then check and select **Continue** and **Commit**.
- c. Select **Enable/Disable** from the third level menu, and click to enable the notification you set up.
- d. Click **Commit**.

Troubleshooting

This section describes some troubleshooting tools and covers these topics:

- "dbdump Command" on page 252
- "tempo-info-gather Command" on page 254
- "cminfo Command" on page 255

dbdump Command

You can run the `dbdump` script to see an inventory of the Altix ICE database.

The `dbdump` command is, as follows:

```
/opt/sgi/sbin/dbdump --admin  
/opt/sgi/sbin/dbdump --leader  
/opt/sgi/sbin/dbdump --rack [--rack ]  
/opt/sgi/sbin/dbdump
```

- Use the `--admin` argument to dump the system admin controller (admin node)
- Use the `--leader` argument to dump all rack leader controllers (leader nodes)
- Use the `--rack` argument to dump a specific rack

- Use the `dbdump` command without any argument to dump the entire Altix ICE system.

EXAMPLES

Example 5-1 dbdump Command Examples

To dump the entire database, perform the following:

```
system-admin:~ # dbdump
0 is { cluster=oscar ifname=service0-bmc dev=bmc0 ip=172.24.0.3 net=head-bmc node=service0
  nodetype=oscar_service mac=00:30:48:8e:
1 is { cluster=oscar ifname=service0 dev=eth0 ip=172.23.0.3 net=head node=service0
  nodetype=oscar_service mac=00:30:48:33:53:2e }
2 is { cluster=oscar ifname=service0-ib0 dev=ib0 ip=10.148.0.2 net=ib-0 node=service0
  nodetype=oscar_service }
3 is { cluster=oscar ifname=service0-ib1 dev=ib1 ip=10.149.0.2 net=ib-1 node=service0
  nodetype=oscar_service }
4 is { cluster=oscar dev=eth0 ip=128.162.244.86 net=public node=oscar_server
  nodetype=oscar_server mac=00:30:48:34:2B:E0 }
...
```

Note: Some of the sample output in this section has been modified to fit the format of this manual.

To dump just the rack leader controller, perform the following:

```
sys-admin:~ # /opt/sgi/sbin/dbdump --leader
0 is { cluster=rack1 ifname=r1lead-bmc dev=bmc0 ip=172.24.0.2 net=head-bmc node=r1lead
  nodetype=oscar_leader mac=00:30:48:8a:a4:c2 }
1 is { cluster=rack1 ifname=lead-bmc dev=eth0 ip=192.168.160.1 net=bmc node=r1lead
  nodetype=oscar_leader mac=00:30:48:33:54:9e }
2 is { cluster=rack1 ifname=lead-eth dev=eth0 ip=192.168.159.1 net=gbe node=r1lead
  nodetype=oscar_leader mac=00:30:48:33:54:9e }
3 is { cluster=rack1 ifname=r1lead dev=eth0 ip=172.23.0.2 net=head node=r1lead
  nodetype=oscar_leader mac=00:30:48:33:54:9e }
4 is { cluster=rack1 ifname=r1lead-ib0 dev=ib0 ip=10.148.0.1 net=ib-0 node=r1lead
  nodetype=oscar_leader }
5 is { cluster=rack1 ifname=r1lead-ib1 dev=ib1 ip=10.149.0.1 net=ib-1 node=r1lead
  nodetype=oscar_leader }
```

To dump just one rack, perform the following:

```
sys-admin:~ # /opt/sgi/sbin/dbdump --rack 1
0 is { cluster=rack1 ifname=i0n0-bmc dev=bmc0 ip=192.168.160.10 net=bmc node=rli0n0
  nodetype=oscar_clients mac=00:30:48:7a:a7:96 }
1 is { cluster=rack1 ifname=i0n0-eth dev=eth0 ip=192.168.159.10 net=gbe node=rli0n0
  nodetype=oscar_clients mac=00:30:48:7a:a7:94 }
2 is { cluster=rack1 ifname=rli0n0-ib0 dev=ib0 ip=10.148.0.3 net=ib-0 node=rli0n0
  nodetype=oscar_clients }
3 is { cluster=rack1 ifname=rli0n0-ib1 dev=ib1 ip=10.149.0.3 net=ib-1 node=rli0n0
  nodetype=oscar_clients }
4 is { cluster=rack1 ifname=i0n1-bmc dev=bmc0 ip=192.168.160.11 net=bmc node=rli0n1
  nodetype=oscar_clients mac=00:30:48:7a:a7:86 slot=1 }
5 is { cluster=rack1 ifname=i0n1-eth dev=eth0 ip=192.168.159.11 net=gbe node=rli0n1
  nodetype=oscar_clients mac=00:30:48:7a:a7:84 slot=1 }
6 is { cluster=rack1 ifname=rli0n1-ib0 dev=ib0 ip=10.148.0.4 net=ib-0 node=rli0n1
  nodetype=oscar_clients slot=1 }
7 is { cluster=rack1 ifname=rli0n1-ib1 dev=ib1 ip=10.149.0.4 net=ib-1 node=rli0n1
  nodetype=oscar_clients slot=1 }
8 is { cluster=rack1 ifname=i0n10-bmc dev=bmc0 ip=192.168.160.20 net=bmc node=rli0n10
  nodetype=oscar_clients slot=10 }
9 is { cluster=rack1 ifname=i0n10-eth dev=eth0 ip=192.168.159.20 net=gbe node=rli0n10
  nodetype=oscar_clients slot=10 }
10 is { cluster=rack1 ifname=rli0n10-ib0 dev=ib0 ip=10.148.0.13 net=ib-0 node=rli0n10
  nodetype=oscar_clients slot=10 }
...
```

tempo-info-gather Command

The tempo-info-gather command enables to collect vital system data especially when troubleshooting problems. The tempo-info-gather command collects the information about the following:

- Digital media dminfo files, syslogs, Dynamic Host Configuration Protocol (DHCP), network file system (NFS)
- MySQL cluster database dump
- Network service configuration files, for example, C3, Ganglia, DHCP, domain name service (DNS) configuration files
- A list of installed system images

- Log files in `/var/log/messages`
- Chassis management control (CMC) slot table for each rack
- basic input-output system (BIOS), Baseboard Management Controller (BMC), CMC and InfiniBand fabric software versions from all Altix ICE nodes

To see a usage statement for the `tempo-info-gather` command, perform the following:

```
sys-admin:/opt/sgi/sbin # tempo-info-gather -h
usage: tempo-info-gather [-h] [-P path] [-o file]
       tempo-info-gather -h           # Print this usage page
       tempo-info-gather -o file      # Tar and gzip the directories
into file (imply -n)
       tempo-info-gather -p path      # Directory to write the data
(default /var/tmp/tempo)
```

cminfo Command

The `cminfo` command is used internally by many of the SGI Tempo scripts that are used to discover, configure, and manage an SGI Altix ICE system.

In a troubleshooting situation, you can use it to gather information about your system. To see a usage statement from a rack leader controller, perform the following:

```
rllead:~ # cminfo --help
Usage: cminfo [--bmc_base_ip|--bmc_ifname|--bmc_iftype|--bmc_ip|--bmc_mac|--bmc_netmask|--bmc_nic|
--dns_domain|--gbe_base_i
p|--gbe_ifname|--gbe_iftype|--gbe_ip|--gbe_mac|--gbe_netmask|--gbe_nic|--head_base_ip|
--head_bmc_base_ip|--head_bmc_ifname|
--head_bmc_iftype|--head_bmc_ip|--head_bmc_mac|--head_bmc_netmask|--head_bmc_nic|--head_ifname|
--head_iftype|--head_ip|--he
ad_mac|--head_netmask|--head_nic|--ib_0_base_ip|--ib_0_ifname|--ib_0_iftype|--ib_0_ip|--ib_0_mac|
--ib_0_netmask|--ib_0_nic|
--ib_1_base_ip|--ib_1_ifname|--ib_1_iftype|--ib_1_ip|--ib_1_mac|--ib_1_netmask|
--ib_1_nic|--name|--rack]
rllead:~ # cminfo --bmc_base_ip
```

EXAMPLES

Example 5-2 `cminfo` Command Examples

To see the rack leader node BMC IP address, perform the following:

```
rllead:~ # cminfo --bmc_base_ip  
192.168.160.0
```

To see the rack leader DNS domain, perform the following:

```
rllead:~ # cminfo --dns_domain  
ice.domain_name.mycompany.com
```

To see the BMC nic, perform the following:

```
rllead:~ # cminfo --bmc_nic  
eth0
```

To see the IP address of the ib1 InfiniBand fabric, perform the following:

```
rllead:~ # cminfo --ib_1_base_ip  
10.149.0.0
```

kdump Utility

The `kdump` utility is a `kexec`-based crash dumping mechanism for the Linux operating system. You can download `debuginfo` kernel RPMs for use with crash and any kernel dumps at the following location:<http://support.novell.com/linux/psdb/byproduct.html>.

To get a traceback or system dump, perform the following from the system console:

```
console rli0n0  
^e c l l 8  
^e c l l t      #traceback  
^e c l l c      #dump
```

Note: This example shows the letter “c”, a lowercase L “l”, and the number one “1” in all three lines.

On the admin node, go to `/net/rllead/var/log/consoles` for the traceback and `/net/rllead/var/log/dumps/rli0n0` for the system dump.

You can dump a compute node, the rack leader, such as, `r1lead`, or a service node, such as, `service0`.

System Firmware

Note: Your SGI Altix ICE system comes preinstalled with the appropriate firmware. See your SGI field support person for any BMC, BIOS, and CMC firmware updates.

The SGI Altix ICE system firmware software consists of the following components:

`sgi-ice-blade-bmc-1.43.5-1.x86_64.rpm`

Blade BMC firmware and update tool

`sgi-ice-blade-bios-2007.08.10-1.x86_64.rpm`

Blade BIOS image and update tool

`sgi-ice-cmc-0.0.11-2.x86_64.rpm`

CMC firmware and update tool

BIOS Version Interrogation

To identify the BIOS you need both the version and the release date. You can get these using the `dmidecode` command. Log onto the node on which you want to interrogate BIOS level and perform the following:

```
# dmidecode -s bios-version; dmidecode -s bios-release-date
```

BMC Revision Interrogation

The BMC firmware revision can be retrieved using the `ipmitool`. For example, if you are logged onto the `r1lead` rack leader controller, the following command gets the BMC firmware revision:

```
# ipmitool -U ADMIN -P ADMIN -I lanplus -H r1i0n0-bmc bmc info | grep 'Firmware Revision'
```

CMC Version Interrogation

The CMC firmware version can be retrieved using the `version` command to the CMC. For example, if you are logged onto the `r1lead` rack leader controller, the following command gets the CMC firmware version:

```
# ssh root@r1i0-cmc version
```

InfiniBand Version Interrogation

The `ibstat` command retrieves information for the InfiniBand links including the firmware version. The following command gets the InfiniBand firmware version:

```
# ibstat | grep Firmware
```

Getting Firmware Information for All System Nodes

The `firmware_revs` script on the system admin controller (admin node) collects the firmware information for all nodes in the SGI Altix ICE system, as follows:

```
system-admin:~ # firmware_revs
BIOS versions:
-----
admin: 6.00
r1lead: 6.00
service0: 6.00
r1i0n0: 6.00
r1i0n1: 6.00
r1i0n8: 6.00
r1i1n0: 6.00
r1i1n1: 6.00
r1i1n8: 6.00

BIOS release dates:
-----
admin: 05/10/2007
r1lead: 05/10/2007
service0: 05/10/2007
r1i0n0: 05/29/2007
r1i0n1: 05/29/2007
```

```
rli0n8: 05/29/2007
rli1n0: 05/29/2007
rli1n1: 05/29/2007
rli1n8: 05/29/2007
```

BMC versions:

```
-----
admin: 1.31
r1lead: 1.31
service0: 1.31
rli0n0: 1.29
rli0n1: 1.29
rli0n8: 1.29
rli1n0: 1.29
rli1n1: 1.29
rli1n8: 1.29
```

CMC versions:

```
-----
rli0c: 0.0.9pre10
rli1c: 0.0.9pre10
```

Infiniband versions:

```
-----
r1lead: 4.7.600
service0: 4.7.600
rli0n0: 1.2.0
rli0n0: 1.2.0
rli0n1: 1.2.0
rli0n1: 1.2.0
rli0n8: 1.2.0
rli0n8: 1.2.0
rli1n0: 1.2.0
rli1n0: 1.2.0
rli1n1: 1.2.0
rli1n1: 1.2.0
rli1n8: 1.2.0
rli1n8: 1.2.0
```

Index

A

- admin node
 - installing software, 31

B

- backing up and restoring the system data base, 181
- baseboard management controller (BMC), 6
- basic system building blocks, 1
- batch service node, 11
- blademond daemon, 75
- boot order
 - service nodes, 158

C

- C3 commands, 160
- C4 administrative interface
 - cadmin, 165
- cadmin command, 165
 - set service node boot order, 167
- cascading dual-boot, 117
- chassis management control (CMC), 9
- chassis management control (CMC) blade
 - embedded Ethernet switches, 15
 - RJ45 connections, 16
- chassis management controller (CMC) , 5
- cimage command, 141
- cinstallman command, 131
- cluster manager software, 29
- cminfo command, 255
- cnodes command, 153
- commands
 - cadmin, 165

- cimage, 141
- cinstallman, 131
- cminfo, 255
- cnodes, 153
- configure-cluster, 47
- console, 168
- cpower, 154
- crepo, 129
- dbdump, 252
- discover, 69
- discover-rack
 - blademond daemon, 75
- mysqldump, 183
- smadmin, 195
- smconfig, 193
- tempo-info-gather, 254
- compute node, 10
 - software
 - customizing, 134
 - customizing for additional network interfaces, 136
 - services turned off, 128
- compute node software, 127
- configure-cluster command, 47
- configuring the service node
 - for DNS, 84
 - for NAT, 80
 - for NFS, 84
 - for NIS for the house network, 85
 - using external DNS for compute node name resolution, 83
- conserv console management package, 168
- conserv console software package, 168
- console management, 168
- cpower command, 154
- creating user accounts, 108
- crepo command, 129

D

- database for the system back up and restore procedure, 181
- dbdump command, 252
- discover command, 69
- discover rack command, 75
- discovering compute nodes, 76
- DNS
 - service node configuration, 84

E

- Embedded Support Partner (ESP), 250

G

- gateway service node, 11
- getting firmware information for all system nodes, 258

H

- hardware hierarchy, 6
- hardware overview, 1
- hierarchy of nodes, 6
- home directories on NAS, 92

I

- individual rack unit (IRU), 11
- InfiniBand fabric, 21
 - administrative commands, 190
 - configuration and operation overview, 199
 - diagnostic commands
 - ibdiagnet, 218
 - ibnetdiscover, 217
 - ibstat, 214

- ibstatus, 214
 - perfquery, 216
- management, 183
- overview, 183
- routing engine variables, 204
- utilities and diagnostics, 213
- Infiniband network, 28
- installing software on rack leader controllers, 72
- installing software on service nodes, 72
- interconnect verification tool (IVT) , 15
- introduction, 1
- inventory verification tool (IVT), 236

K

- kdump utility
 - system dump, 257
 - traceback, 257
- keeping time synchronized, 170

L

- login service node , 11

M

- main power, 5
- monitoring system metrics with Performance Co-Pilot, 245
- MPI
 - default configuration, 3
- multiroot, 118
- mysqldump command, 183

N

- NAS home directories, 92

NAT

- configuring the service node, 80
- network interface naming conventions, 22, 26
 - hostnames, 26
 - Infiniband network, 28
 - non-resolvable Names, 26
 - system component names, 23
 - VLAN_1588, 26
 - VLAN_BMC, 25
 - VLAN_GBE, 24
 - VLAN_Head, 23
- network time protocol (NTP), 170
- networks
 - Gigabit Ethernet (GigE) and 10/100 Ethernet connections, 15
 - InfiniBand fabric, 21
 - network interface naming conventions, 22
 - overview, 13
 - virtual local area networks (VLANs), 17

NFS

- service node configuration, 84
- service node NFS server alternate:
 - re-exporting house NFS servers, 92

NIS

- service node configuration for the house network, 85

node replacement procedure, 226

nodes

- batch service node, 11
- compute, 10
- gateway, 11
- login service, 11
- rack leader controller
 - leader node, 9
- storage service, 12
- system admin controller
 - admin node, 8

O

overview, 1

007-4993-007

P

- Performance Co-Pilot, 245
- power management
 - cpower command, 154
 - IPMI-style commands, 156
 - IRU, rack, and system domains, 157
 - operation on nodes, 155
 - shutting down and booting, 157
 - boot order, 158
- power supply
 - BMC, 5
 - CMC, 5
 - compute blades, 5
 - main power, 5

R

- rack leader controller, 5, 9
- restarting the InfiniBand fabric after a system reboot, 184

S

- service node boot order, 158
- setting up a NIS Server, 95
- setting up an NFS home server on a service node, 86
 - partitioning, creating, and mounting filesystems, 89
- setting up serial over LAN connection, 15
- setting up the Embedded Support Partner (ESP), 250
- SGI Tempo systems management software, 1
- shelf spare replacement, 227
 - booting a replacement system, 234
 - importing the disk volumes, 232
 - installing hardware, 229
- smadmin command, 195

- smconfig command, 193
- storage service node, 12
- system admin controller, 5, 8
 - installing software, 31
- system component names, 23
- system firmware, 257
 - BIOS version interrogation, 257
 - BMC revision interrogation, 257
 - CMC revision interrogation, 258
 - getting firmware information for all system nodes, 258
 - InfiniBand version interrogation, 258
- system monitoring
 - operation, 243
 - overview, 239
 - with Performance Co-Pilot, 245
 - monitoring SDR metrics, 248
- system overview, 1

T

- tempo-info-gather command, 254
- troubleshooting, 252

- cminfo, 255
- dbdump, 252
- tempo-info-gather, 254

U

- user accounts
 - creating, 108

V

- virtual local area networks (VLANs), 17
 - VLAN_1588, 17
 - VLAN_BMC, 17
 - VLAN_GBE, 17
 - VLAN_HEAD, 17
- VLAN_1588 network connections, 26
- VLAN_BMC network connections, 25
- VLAN_GBE network connections, 24
- VLAN_Head network connections, 23