

File No. S370/303X/308X/309X/4300/8100/S1-09

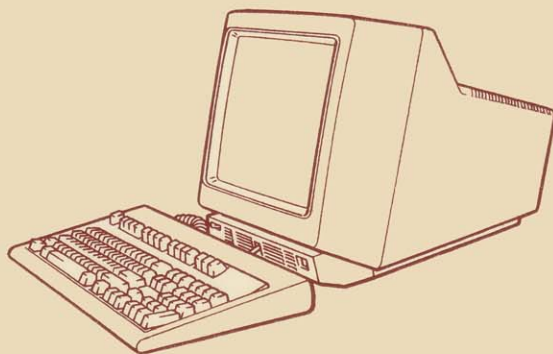

IBM 3151 ASCII Display Station

Guide to Operations



File No. S370/303X/308X/309X/4300/8100/S1-09



IBM 3151 ASCII Display Station

Guide to Operations

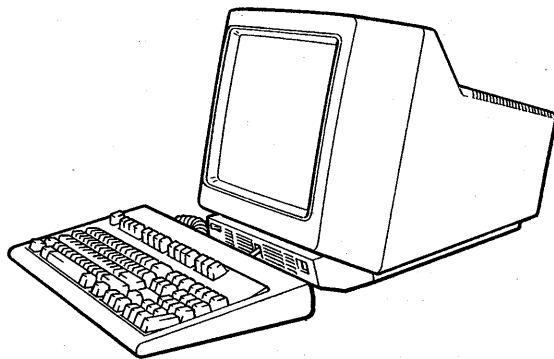

First Edition (May 1987)

Changes are made periodically to the information herein; any such changes will be reported in subsequent revisions or Technical Newsletters.

References in this publication to IBM products, programs, or services do not imply that IBM intends to make these available in all countries in which IBM operates. Any reference to an IBM program product in this publication is not intended to state or imply that only IBM's program product may be used. Any functionally equivalent program may be used instead.

Publications are not stocked at the address given below. Requests for IBM publications should be made to your IBM representative, to the IBM branch office serving your locality, or to the place of purchase.

A form for reader's comments is provided at the back of this publication. If the form has been removed, comments may be addressed to IBM Corporation, Publications Development, Department 6R1J, 180 Kost Road, Mechanicsburg, PA 17055 U.S.A. IBM may use or distribute whatever information you supply in any way it believes appropriate without incurring any obligation to you.

© Copyright International Business Machines Corporation 1987

FEDERAL COMMUNICATIONS COMMISSION (FCC) STATEMENT

(Applies only to those machines used in the U.S.)

Warning: This equipment generates, uses, and can radiate radio frequency energy and if not installed and used in accordance with the instruction manual, may cause interference to radio communications. It has been tested and found to comply with the limits for a Class A computing device pursuant to Subpart J of Part 15 of FCC Rules, which are designed to provide reasonable protection against such interference when operated in a commercial environment. Operation of this equipment in a residential area is likely to cause interference in which case the user at his own expense will be required to take whatever measures may be required to correct the interference.

CAUTION

When the video element requires disposal, do not handle it as normal trash, because the video element contains a lithium battery (3 V, 180 mAh, UL¹ recognized component or equivalent). The lithium battery contains about 70 mg of lithium and can be harmful to people and may explode if not properly used, handled, or disposed of, such as; (1) thrown into water, (2) overheated to more than 100°C (212°F), or (3) attempting to recharge, repair, or disassemble. When disposing the video element, follow your company's safety procedures or local procedures, which defines the disposal of such items.

¹ Registered trademark of Underwriters Laboratories Inc.

Using This Guide

This guide introduces the IBM 3151 ASCII Display Station and describes the installation and operation of the IBM 3151. This guide is intended for those who want to:

- Understand what the IBM 3151 is
- Install and set up the IBM 3151
- Operate the IBM 3151.

This guide has five chapters and two appendixes:

- Chapter 1, “Introducing the IBM 3151” introduces the IBM 3151 and describes its operations.
- Chapter 2, “Setup Procedures” describes how to install and set up the IBM 3151.
- Chapter 3, “Understanding the Keyboard Functions” describes the function of each key.
- Chapter 4, “Interpreting Operator Messages” describes how to interpret the operator messages that are displayed at the bottom of the screen.
- Chapter 5, “Solving Problems” describes how to isolate display station problems.
- Appendix A, “Emulating the IBM 3101 Display Terminal” contains information about the IBM 3101 emulation.

Using This Guide

- Appendix B, “Emulating the Ten ASCII Terminals” provides information to emulate one of the following ASCII terminals.
 - ADM²-3A
 - ADM-5
 - ADDS³ Viewpoint-A2
 - Hazeltine⁴ 1500
 - TeleVideo⁵ Model 910
 - TeleVideo Model 910⁺
 - TeleVideo Model 912
 - TeleVideo Model 920
 - TeleVideo Model 925
 - TeleVideo Model 925E.

² Registered trademark of Zentec Corporation

³ Trademark of Applied Digital Data Systems, Incorporated

⁴ Trademark of Esprit Systems, Incorporated

⁵ Trademark of TeleVideo Systems, Incorporated

Related Publications

Related IBM Publications

- *IBM 3151 ASCII Display Station Reference Manual*, GA18-2634
- *User's Guide for the Cartridge to Emulate IBM and DEC⁶ Terminals*, GA18-2654
- *User's Guide for the Cartridge to Emulate WYSE WY-50/50+⁷ Terminals*, GA18-2657

Related Non-IBM Publications

- *Lear Siegler ADM-3A Interactive Display Terminal Operator's Handbook*, 772-300
- *Lear Siegler ADM-5 Dumb Terminal Reference Manual*, DP2160482F
- *Applied Digital Data System ADDS Viewpoint-A2 User's Manual*
- *Hazeltine Corporation Hazeltine 1500 Video Display Terminal Reference Manual*, HI-1056A
- *TeleVideo Model 910 Operator's Manual*, B300003-001
- *TeleVideo Model 910+ Terminal Operator's Manual*, B300021, 1982
- *TeleVideo Models 912/920 Operator's Manual*, B300001, 1979
- *TeleVideo Model 925 CRT Terminal Installation and User's Guide*, B300013-991 Revision B, 1982
- *TeleVideo Model 925E Terminal Operator's Manual*, 131960-00-B, 1984.

⁶ Trademark of Digital Equipment Corporation

⁷ Trademarks of Wyse Technology

Related Publications

Contents

Chapter 1. Introducing the IBM 3151	1-1
Models	1-2
Overview of the IBM 3151	1-4
IBM 3151 Display Station	1-6
Video Element	1-6
Keyboard	1-7
Chapter 2. Setup Procedures	2-1
Setting up the IBM 3151	2-3
Defining Setup Values	2-14
Setup Menus and Setup Value Descriptions	2-17
How to Define Setup Values	2-18
Defining Function Keys	2-38
Chapter 3. Understanding the Keyboard Functions	3-1
Key Index	3-2
What Each Key Does	3-4
Keyboard Without Numeric Keypad	3-17
Chapter 4. Interpreting Operator Messages	4-1
Chapter 5. Solving Problems	5-1
Symptom List	5-2
Unusual Message or Characters Appear	5-4
Alarm Continues to Sound	5-5
Alarm Does Not Sound	5-7
Setup Menu Appears	5-8
Screen is Blank	5-9
Other Display Problems	5-12
Screen is Waving	5-13
Keyboard Problems	5-14
Analysis Procedures	5-15

Contents

Test Pattern 5-17
Communication Problems 5-19
If Service is Required 5-20

Appendix A. Emulating the IBM 3101 Display Terminal A-1

Functions Supported Differently in Emulation Mode A-2

Key Labels A-4

Operator Messages A-5

Functions Not Supported in Emulation Mode A-6

Additional Functions in Emulation Mode A-7

Additional Keyboard Functions A-7

Appendix B. Emulating the Ten ASCII Terminals B-1

Functions Supported Differently in Emulation Mode B-2

Emulation Keyboard B-4

Key Labels B-7

Functions Not Supported in Emulation Mode B-12

Additional Functions in Emulation Mode B-15

Glossary X-1

Index X-9

Figures

- 1-1. IBM 3151 ASCII Display Station 1-1
- 1-2. IBM 3151 Model Functions 1-2
- 1-3. Video Element 1-6
- 1-4. Keyboards 1-7
- 2-1. Selecting a Menu 2-18
- 2-2. Selecting a Field 2-19
- 2-3. Selecting Values 2-20
- 2-4. Saving the Definitions 2-21
- 2-5. GENERAL Menu (IBM 3151 and IBM 3101) 2-22
- 2-6. GENERAL Menu (Ten ASCII Terminals) 2-22
- 2-7. Setup Parameters in the GENERAL Menu 2-23
- 2-8. COMMUNICATION Menu (IBM 3151 and IBM 3101) 2-27
- 2-9. COMMUNICATION Menu (Ten ASCII Terminals) 2-27
- 2-10. Setup Parameters in the COMMUNICATION Menu 2-28
- 2-11. KEYBOARD/PRINTER Menu (IBM 3151 and IBM 3101) 2-30
- 2-12. KEYBOARD/PRINTER Menu (Ten ASCII Terminals) 2-30
- 2-13. Setup Parameters in the KEYBOARD/PRINTER Menu 2-31
- 2-14. FUNCTION Menu (IBM 3151 and IBM 3101) 2-33
- 2-15. FUNCTION Menu (Ten ASCII Terminals) 2-33
- 2-16. Functions in the FUNCTION Menu 2-34
- 2-17. Setup-Value Definitions Set by Mode Adjust Function 2-35
- 2-18. Setup Parameters and Their Possible Values (IBM 3151 and IBM 3101) 2-36
- 2-19. Setup Parameters and Their Possible Values (Ten ASCII Terminals) 2-37
- 2-20. Keys Used for Defining Function Keys 2-38
- 3-1. IBM 3151 Keyboard 3-1
- 3-2. IBM 3151 Keyboard Without Numeric Keypad 3-18
- 3-3. Available Alphanumeric Keys in Numeric Lock Mode 3-18
- 4-1. Operator Information Area 4-3
- 4-2. Operator Messages 4-3
- 5-1. Example of Disconnected Cables and Cartridge 5-1

Figures

- 5-2. IBM 3151 Keyboard IDs 5-18
- A-1. Functions Supported Differently in Emulation Mode A-2
- A-2. IBM 3101 Emulation Keyboard A-3
- A-3. Equivalent Keys A-4
- A-4. Equivalent Operator Messages A-5
- B-1. Functions Supported Differently in Emulation Mode B-2
- B-2. Keyboard Overlay Locations B-3
- B-3. Emulation Keyboard B-6
- B-4. ADM-3A Equivalent Keys B-7
- B-5. ADM-5 Equivalent Keys B-7
- B-6. ADDS Viewpoint-A2 Equivalent Keys B-8
- B-7. Hazeltine 1500 Equivalent Keys B-8
- B-8. TeleVideo Models 925/925E Equivalent Keys B-9
- B-9. TeleVideo Models 912/920 Equivalent Keys B-10
- B-10. TeleVideo Models 910/910+ Equivalent Keys B-11

Chapter 1. Introducing the IBM 3151

The IBM 3151 is an ASCII Display Station used for entering data into or retrieving data from a host system. The display station can be connected to both IBM and non-IBM systems.

The IBM 3151 consists of; a video element, a keyboard, a cartridge, and a stand (accessory) as shown in Figure 1-1.

The U.S. English machine does not use a cartridge for its operation in native (IBM 3151) or built-in emulation modes. An optional cartridge can be inserted into the rear of the video element to emulate other manufacturers' display terminals, whose emulations are not built-in.

The national language models always require a national language cartridge for operations in both native and IBM 3101 emulation modes. The national language cartridges can display characters in their countries' languages.

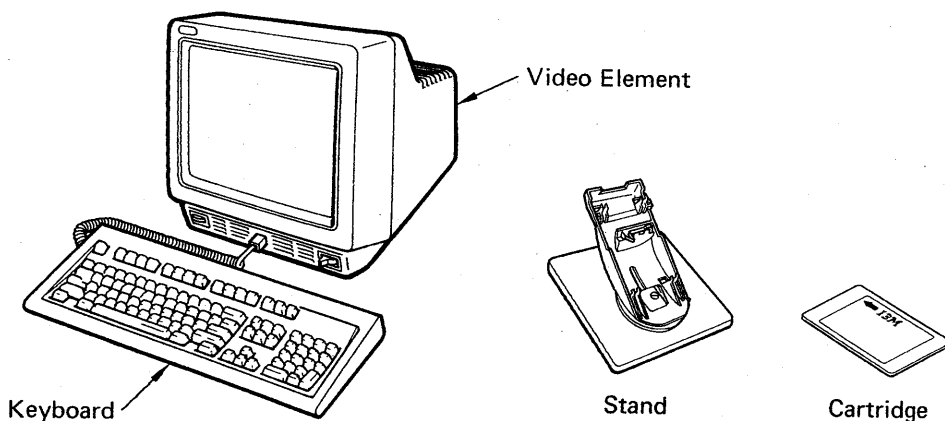

Figure 1-1. IBM 3151 ASCII Display Station

Introduction

Models

Three models are available for the IBM 3151: 11, 31, and 41.

Note: Model numbers will be suffixed by an alphanumeric character, which defines the type of language, for example. In this guide, the suffix is omitted for model numbers.

Models 31 and 41 differ only in the color of the characters displayed on the screen. Characters are displayed in *green* for Models 11 and 31 while they are displayed in *amber-gold* for the Model 41.

The following figure shows the differences in functions between the Model 11 and Models 31 and 41 (in the figure, 'yes' means the function is provided and 'no' means the function is not provided).

Note: Some models may not be available in your county. Ask your IBM representative in the IBM branch office serving your locality, or your place of purchase, for the available models.

Function	Model 11	Models 31 and 41
3101 Emulation	no	yes
Ten ASCII Terminals' Emulation	yes	yes
132-column Screen	no	yes
Keyboard Type	Without Numeric Keypad	With Numeric Keypad
Replaceable Key-Caps	no	yes
Scrolling	Jump and Smooth (Fast)	Jump and Smooth (Fast and slow)

Figure 1-2 (Part 1 of 2). IBM 3151 Model Functions

Introduction

Function	Model 11	Models 31 and 41
Split Screen and Jump Key	no	yes
Blinking Cursor	no	yes
Host Message	no	yes
Subscript, Superscript and Line Drawing	no	yes
PF Keys	12 PF keys and 128-character buffer	36 PF keys and 512-character buffer
PA Keys	no	yes
Pass-through	Outbound	Bidirectional
Optional Cartridge	no	<ul style="list-style-type: none">• IBM 3151 Cartridge to Emulate IBM and DEC Terminals• IBM 3151 Cartridge to Emulate WYSE WY-50/50+ Terminals (U.S. English machine only)

Figure 1-2 (Part 2 of 2). IBM 3151 Model Functions

Introduction

Overview of the IBM 3151

Note: This section describes functions of the IBM 3151 Models 31 and 41. Some functions are not available for the IBM 3151 Model 11. See Figure 1-2 on page 1-2 for more details.

The IBM 3151 display station has the following characteristics.

- **Display (14-inch monochrome flat screen)**
 - Adjust brightness for viewing comfort
 - Display blink, underscore, reverse video, and high intensity characters or display no characters
 - Select normal or reverse video for the whole screen
 - Select the smooth scroll
 - Select the screen format from (1) 24 lines of 80 characters each, (2) 25 lines of 80 characters each, (3) 24 lines of 132 characters each, and (4) 25 lines of 132 characters each.
 - View as many as three viewports simultaneously
 - Extend the life of the CRT (cathode-ray tube) with use of the CRT saver function
 - Determine the host system and display statuses in the operator information area.
- **Keyboard**
 - Adjust the keyboard angle for operating comfort
 - Enter superscript and subscript characters

- Draw lines using special keys
- Numeric Lock key (for keyboard without numeric keypad).
- **Other Functions**
 - Adjust the sound of the audible alarm using the alarm keys
 - Define setup values using setup menus
 - Define function keys
 - Emulate other types of display terminals.

Introduction

IBM 3151 Display Station

This section describes the video element and the keyboard of the IBM 3151.

Video Element

The video element, which also supplies power to the keyboard, is used to display data sent from the host system or data entered from the keyboard.

The video element controls the IBM 3151 functions and communications. It has a keyboard connector on the front side, and connectors for communications and an optional device (such as a printer) on the rear side. It also has the cartridge slot at the rear side.

The optional stand, which enables the adjustments of tilt and swivel for the video element, can be ordered.

Figure 1-3 shows the locations of the controls, indicators, and connectors on the video element.

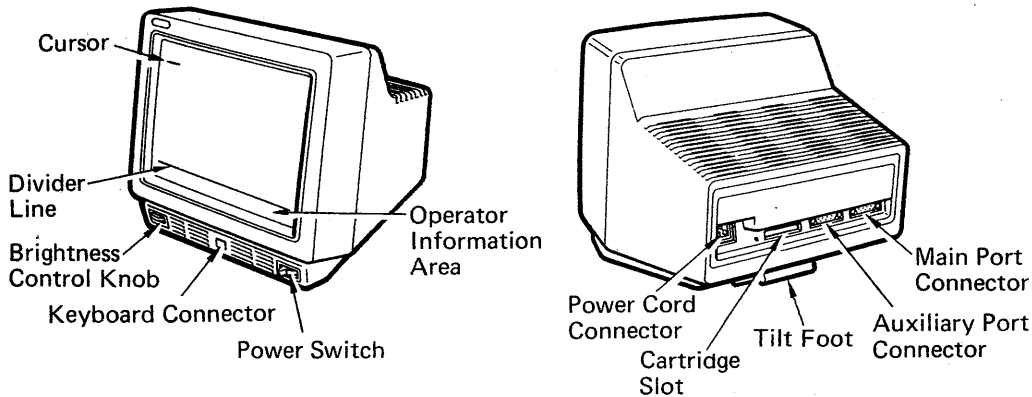

Figure 1-3. Video Element

Keyboard

The keyboard is used to enter data and perform various functions. You can also enter some host commands from the keyboard. Adjustable legs located at the rear of the keyboard allow you to change the keyboard angle for operating comfort.

A keyboard overlay (GX18-2143) is provided to make the use of the function keys easier when the keys are redefined. You can also replace the key caps (IBM 3151 Models 31 and 41 only) with the accessory key caps (key caps are shipped with some emulation cartridges or may be ordered separately from IBM).

The keyboard for the Model 11 provides the numeric lock function for easier data input, instead of the numeric keypad. The replaceable key-caps and line-drawing symbols are not used for this keyboard.

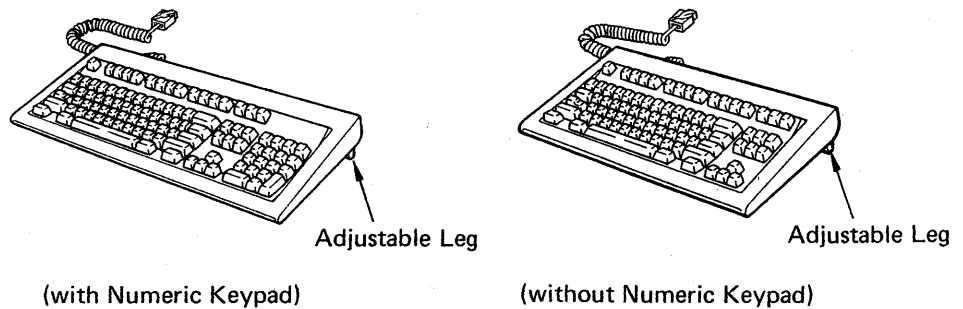

Figure 1-4. Keyboards

Introduction

Chapter 2. Setup Procedures

This chapter provides step-by-step procedures to setup the IBM 3151 when operating it as an IBM 3151, an IBM 3101, or to emulate any of Ten ASCII terminals. Before beginning the setup, the person responsible for the installation should have completed the preparations for installing the IBM 3151. These preparations include:

- Site preparation
- Installation of communication cables, power receptacle, and wiring
- Determination of the setup values.

The above information is described in Chapter 8, "Installation Planning" in the *IBM 3151 ASCII Display Station Reference Manual*, GA18-2634.

If You Use an Optional Cartridge

If you use an optional cartridge, go to the user's guide shipped with the cartridge for all of the installation and setup procedures.



This chapter describes the following:

- Setting up the IBM 3151
- Defining setup values
- Defining function keys

Setup Procedures

- Setup menus and value descriptions.

Notes:

1. *If you have any problems in the following steps, see Chapter 5, "Solving Problems" on page 5-1.*
2. *If needed, save the packing material, which may be required when returning or relocating the IBM 3151. Packing material can also be purchased from IBM.*

Step 1. Checking Parts

Setting up the IBM 3151

Check each box () as you identify each item. If any required items are missing, call your IBM marketing representative or place of purchase.

Video Element

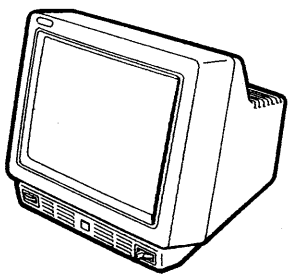

Power Cord

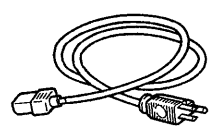

Keyboard

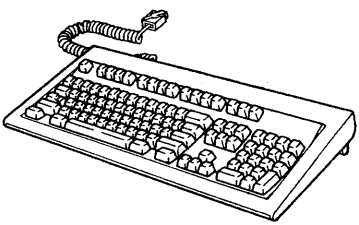

Keyboard Overlay (blank)

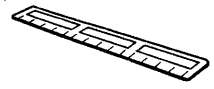

Stand (optional)

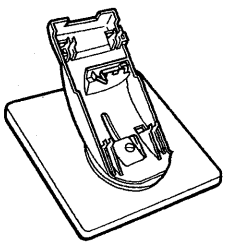

Keyboard Overlay (for Ten ASCII terminals emulation. See Figure B-2 on page B-3 for overlay placement.)



Step 2. Attaching the Label

Important: It is important that you attach the labels to avoid possible delay if it ever becomes necessary to return the unit to IBM.

a Tear off the labels from the back of the video element.

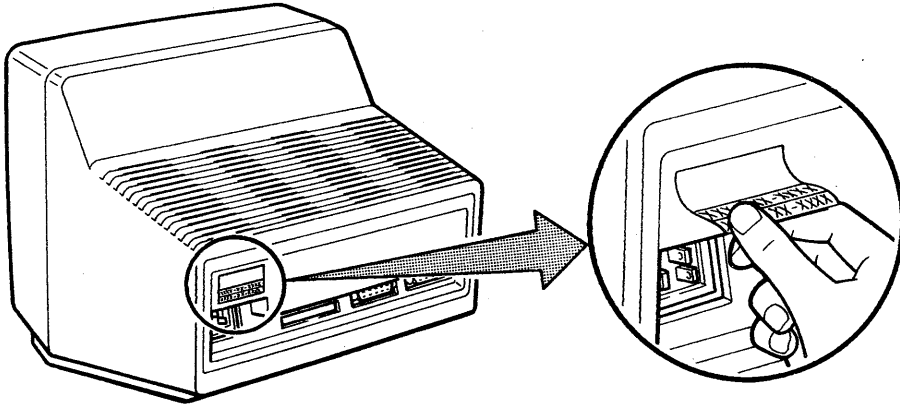

b Attach one label to the front of the video element and the other to the bottom of the keyboard.

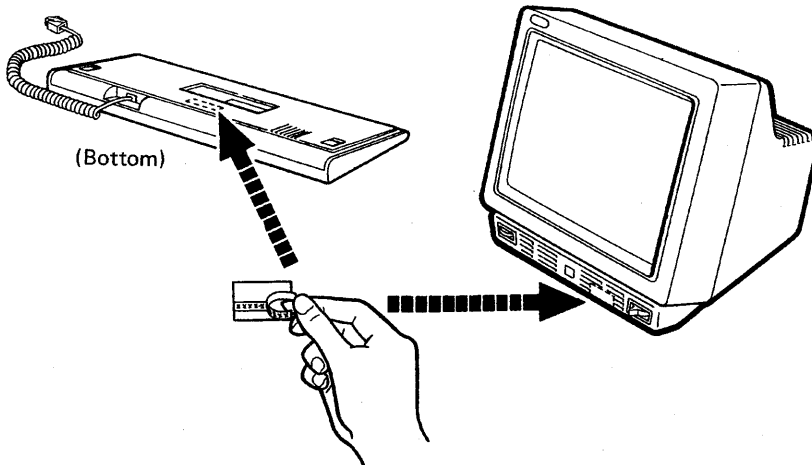

Step 3. Attaching the stand (optional)

a

Customers who do not have the stand (optional):

Skip this step, go to page 2-7 .

Customers who have the stand (optional):

If a stand is available, do this step.

Turn the video element upside down. While pushing the two latches **1** down, slide the tilt foot in the direction of arrow **2** and remove it.

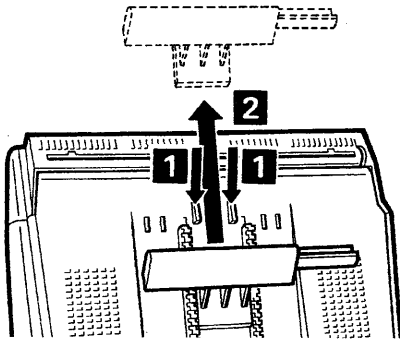

b

Locate the four slots on the video element and the four hooks on the stand.

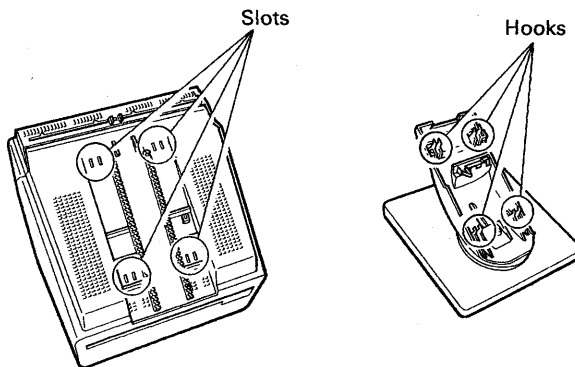

Step 3. Attaching the stand (optional)

- c** Insert the four hooks of the stand into four slots of the video element, then push the stand down slightly and slide it backward until it snaps into place.

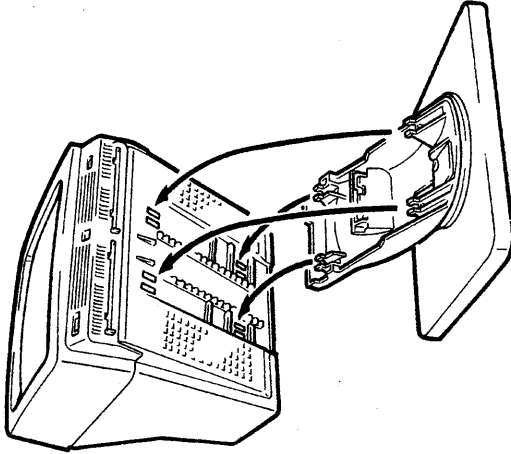

- d** By looking through the two holes of the stand, ensure that the hooks go into the corresponding slots of the video element.

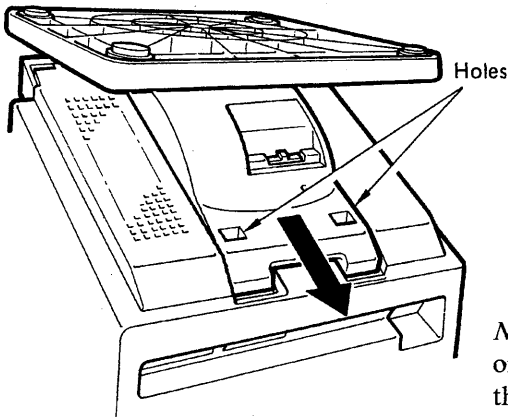

Note: Ensure that the stand is locked onto the video element by moving the stand forward and backward.

Step 4. Connecting the Cables

a

DANGER

Do not perform this step during an electrical storm. Communication cables can conduct lethal charges of electricity.

Insert the communication cable fully into the video element, and tighten the screws.

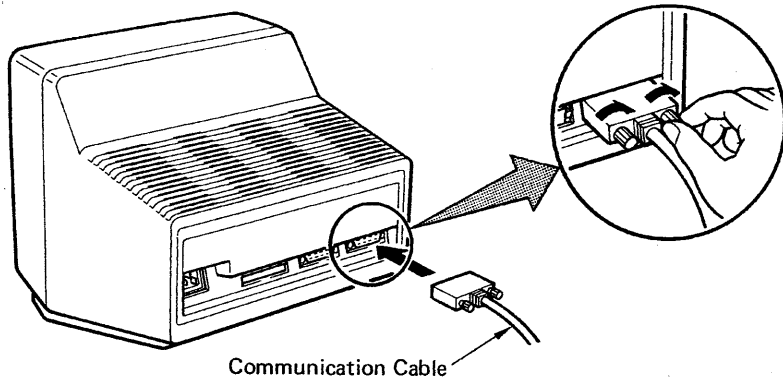

b

To connect a printer or any other device, insert its cable into the video element, and tighten the screws.

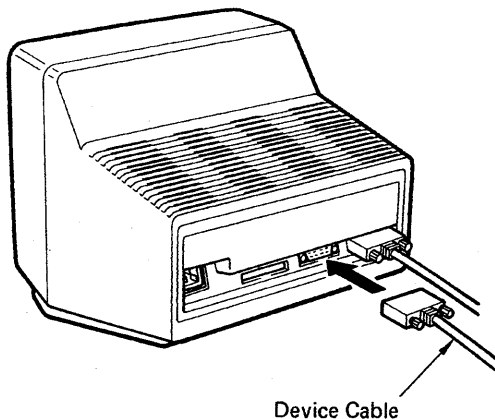

Step 4. Connecting the Cables

c Insert the keyboard cable into the video element.

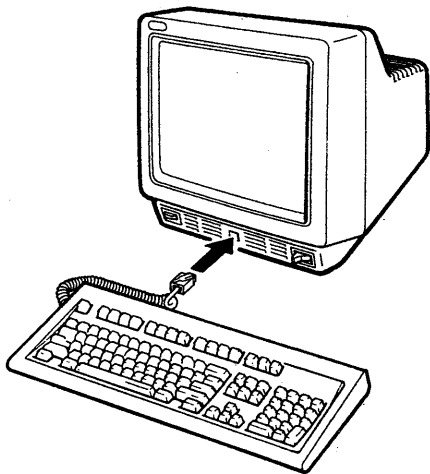

Step 5. Setting the Keyboard Angle and Placing the Overlay

a Adjust the legs as needed.

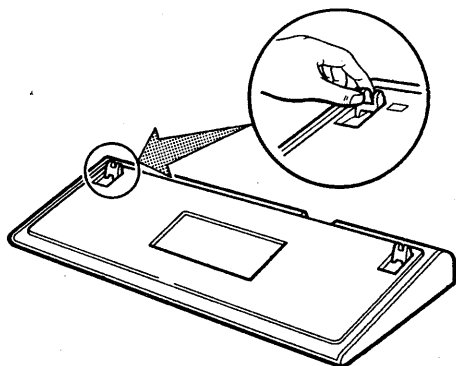

b Place the overlay (GX18-2143) on the keyboard.

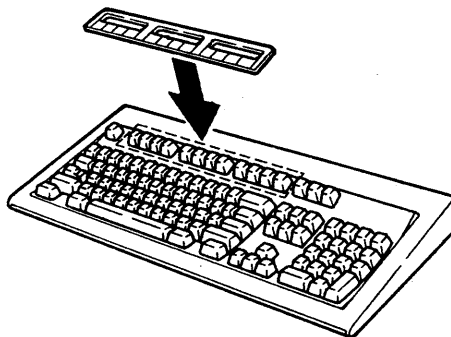

Step 6. Powering-on the Display Station

CAUTION

The power cord plug is approved for use with this display station and meets the relevant testing laboratory, country, or test-house standards. For your safety, the plug must be connected to a properly wired and grounded receptacle. An improperly wired receptacle could place a hazardous voltage on accessible metal parts of the display station. The customer is responsible for receptacle wiring.

Notice for Customers in Chicago, Illinois: Use the 1.8 m (6 ft) power cord.

a

Make sure the power switch is set to O (Off).

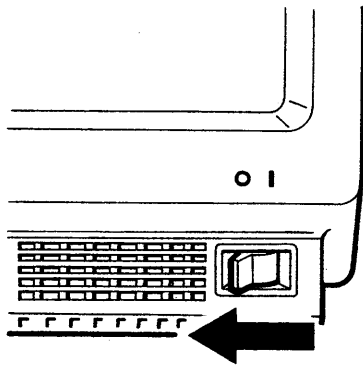

Step 6. Powering-on the Display Station

- b** Insert the power cord into the video element; insert the other end into a power outlet.

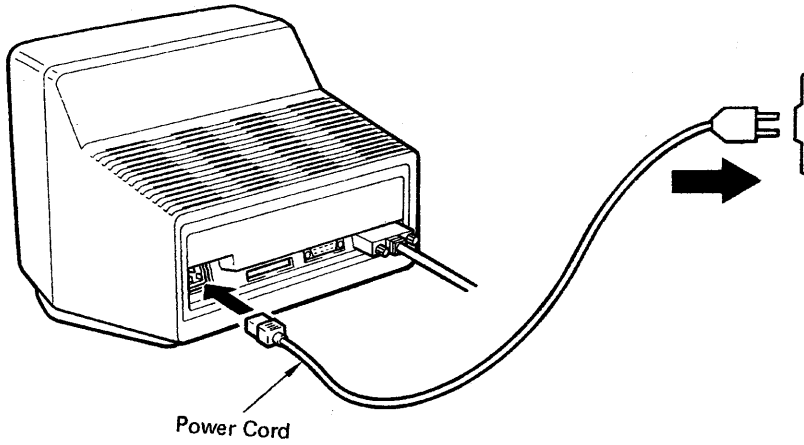

- c** Set the power switch to I (On).

The setup menu should appear, and the audible alarm should sound.

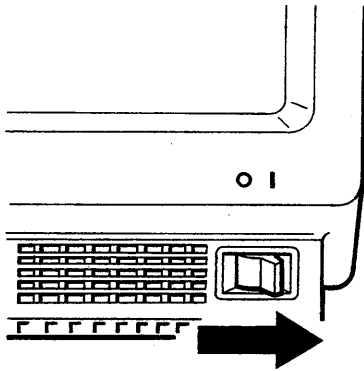

Step 7. Adjusting the Screen Brightness

a

Adjust the (☀) brightness knob until the brightness is set at a comfortable viewing level.

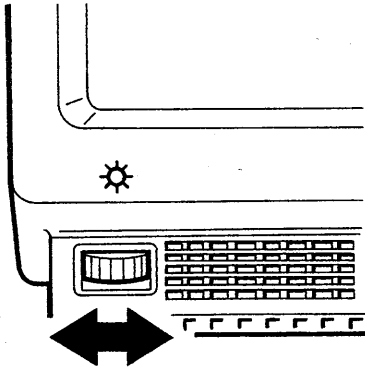

Step 8. Positioning the Video Element for Viewing Comfort

a

Customers who do not have the stand (optional):

If a stand is not available, do this step.

Customers who have the stand (optional):

Skip this step, go to page 2-13 .

Lift the rear of the video element to slide the tilt foot as needed.

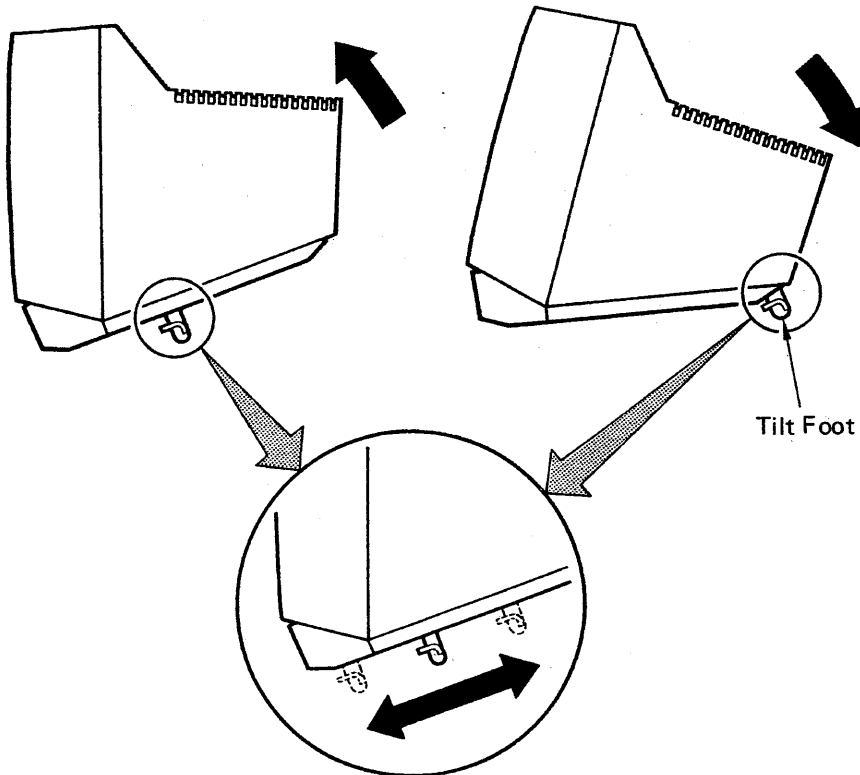

Step 9. Adjusting the Audible Alarm Sound

a

To increase the sound of the audible alarm:

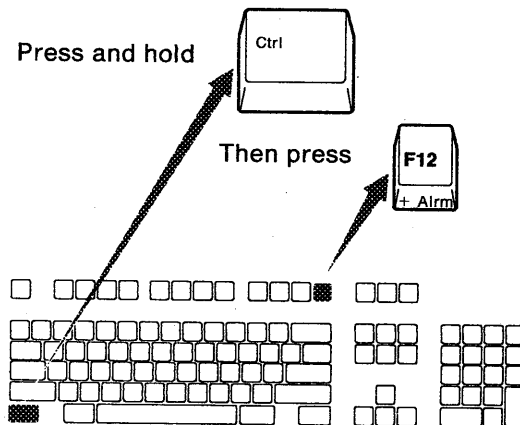
**b**

To decrease the sound of the audible alarm:

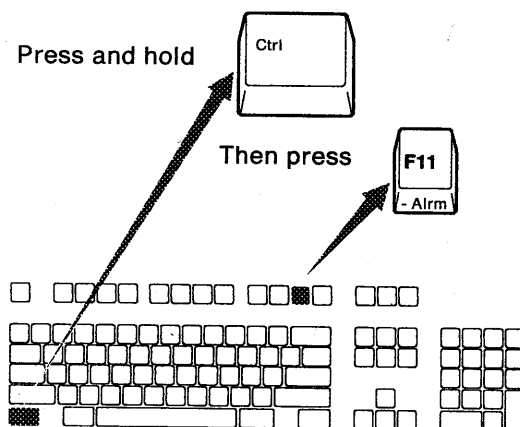

Repeat these steps until the alarm is set to a comfortable sound level.

Defining Setup Values

Defining Setup Values

You must define the setup values so that the display station can correctly communicate with the host system or printer. The person responsible for setting up the display station should have selected the values for your installation. Get the setup sheet from that person and refer to it and do the following steps.

If you are the person responsible for setting up the display station you must define the setup values, see "Setup Menus and Setup Value Descriptions" on page 2-17 for more information.

a

Set the power switch to I (On).

The GENERAL menu will appear as shown below.

Note: If you have already defined the setup values, the GENERAL menu will not appear. In this case, press and hold the *Ctrl* key; then press the *Setup* key.

S E T U P M E N U			
GENERAL	COMMUNICATION	KEYBOARD/PRINTER	FUNCTION
Machine Mode	IBM 3151	Forcing Insert	OFF
Screen	NORMAL	Tab	FIELD
Row and Column	24 x 80		
Scroll	JUMP		
Auto LF	ON		
CRT Saver	OFF	Term.ID _____	
Line Wrap	ON		

Defining Setup Values

b Refer to Figure 2-18 on page 2-36 or Figure 2-19 on page 2-37; select the field and change the value, if needed.

- 1 Using the *Cursor Move* keys (↑ ↓ ← →), select any field (reverse box) whose value you want to change.
- 2 Press the *Space Bar* to display each value. Do this until the desired value appears.
- 3 Repeat steps 1 and 2 until you have changed all necessary values.

Note: For the terminal ID value, key in the characters instead of pressing the *Space Bar*.

- 4 Select the next menu by pressing the *Send* key, and change all necessary values. Follow the same procedures for all menus (GENERAL, COMMUNICATION, KEYBOARD/PRINTER), except the FUNCTION menu, which has a different purpose.

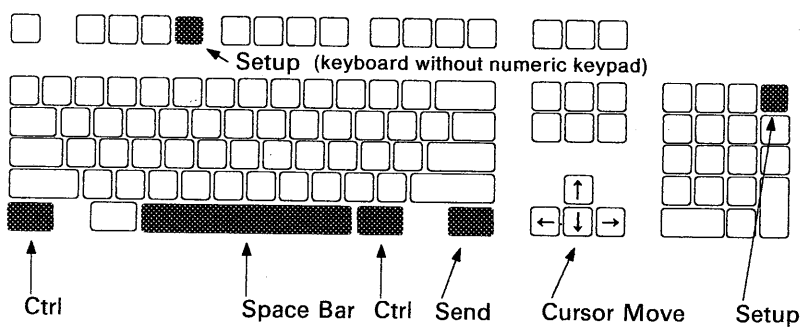

Defining Setup Values

C Select the FUNCTION menu to save the definitions that you have made on the GENERAL, COMMUNICATION, and KEYBOARD/PRINTER menus.

- 1** Select the FUNCTION menu by pressing the *Send* key from the KEYBOARD/PRINTER menu.

The FUNCTION menu should look like this.

S E T U P M E N U			
GENERAL	COMMUNICATION	KEYBOARD/PRINTER	FUNCTION
Recall	Save	Default	
Reset Terminal	Clear Status*	Mode Adjust*	

* The **Clear Status** and **Mode Adjust** options do not appear when you select IBM 3151 or IBM 3101 machine modes.

- 2** Select the Save field using the *Cursor Move* keys (↑ ↓ ← →).
- 3** Press the *Space Bar*.
A blinking "Completed" will appear telling you that the setup-value definitions are saved.
- 4** Press and hold the *Ctrl* key; then press the *Setup* key to exit this mode.
- 5** Copy the setup values onto Figure 2-18 on page 2-36 or Figure 2-19 on page 2-37 according to the setup sheet.

Setup procedures are now complete.

Setup Menus and Setup Value Descriptions

This section describes the setup menus; how you can change the setup values; what the setup menus are; and what the setup values mean.

The appearance of the setup menu is different when IBM 3151, IBM 3101, or other emulation terminals (Ten ASCII terminals) are selected.

Warning: The setup values are stored in the video element, which means that when you first install the display station or if you ever replace the video element, you must define these values. Otherwise, the display station may not work correctly.

Note: This section describes functions of the IBM 3151 Models 31 and 41. Some functions are not available for the IBM 3151 Model 11. See Figure 1-2 on page 1-2 for more details.

How to Define Setup Values

How to Define Setup Values

This section describes how the setup menus are organized and how you can change the setup values through the menus.

Selecting a Menu

The GENERAL menu appears whenever you press the *Setup* key while holding down the *Ctrl* key. You can select the next menu by pressing the *Send* key. Each menu appears in the order shown in Figure 2-1. The current menu name appears in reverse video on the second line of each menu. To quit a menu without saving the definitions, press the *Setup* key while holding down the *Ctrl* key.

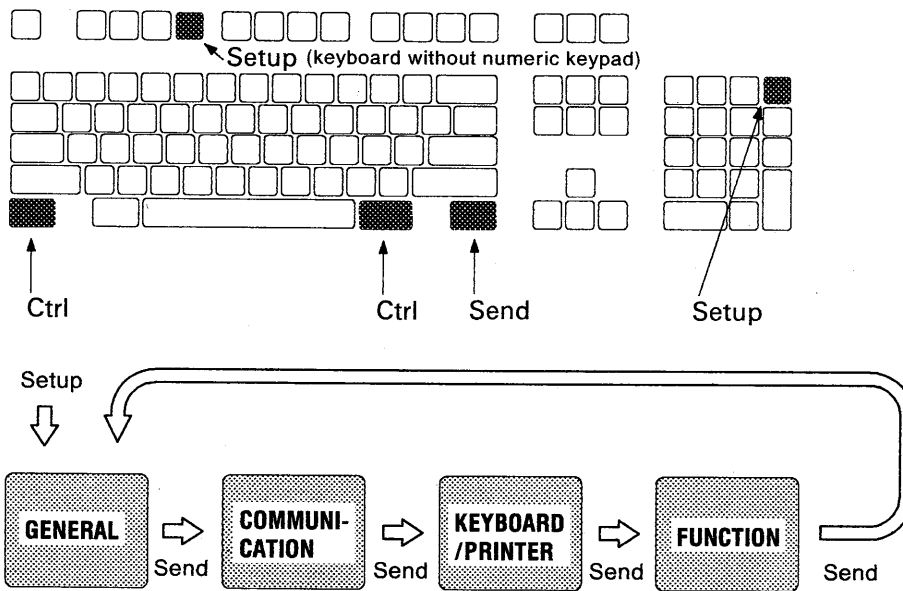

Figure 2-1. Selecting a Menu

How to Define Setup Values

Selecting a Field in the Menu

You can select a field using the *Cursor Move* keys. The setup value of the current field is displayed in reverse video.

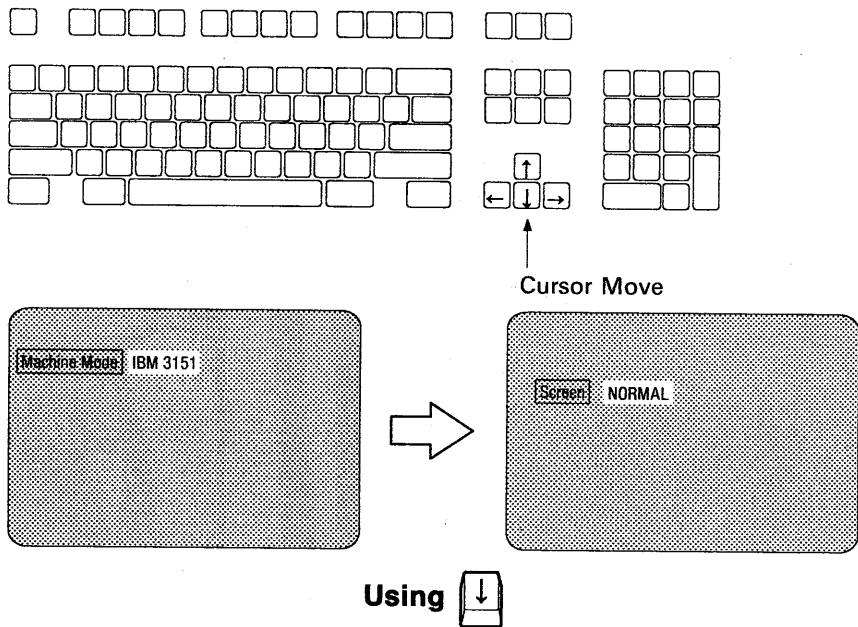
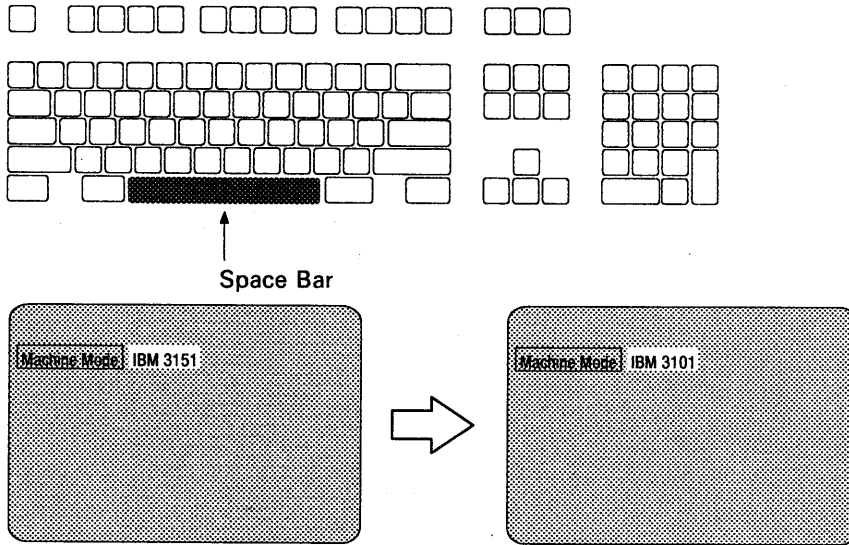

Figure 2-2. Selecting a Field

How to Define Setup Values

Selecting Values in the Fields

You can select a value for any field using the *Space Bar*. Press the *Space Bar* until the desired value appears. You only key in characters when defining the terminal ID (identification). When the *Space Bar* is pressed while holding down the *Shift* key, you can select the previous value. If you try to key in characters in any other field, the audible alarm will sound.



Using Space Bar

Figure 2-3. Selecting Values

How to Define Setup Values

Saving the Definitions

When you complete the setup-value definitions for each menu, select the **FUNCTION** menu to save those values. Select the **Save** field and then press the *Space Bar*. When the save operation successfully completes, **Completed** is displayed (blinking). Notice that the function of the *Space Bar* is different here from the other menus.

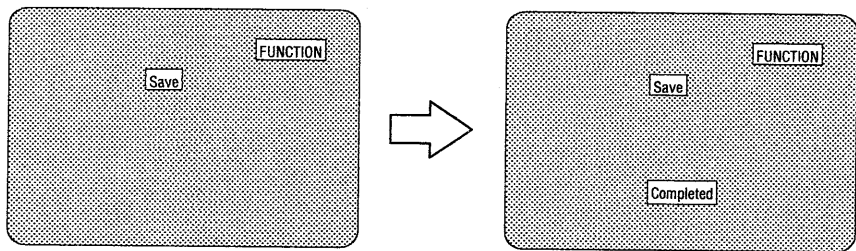

Using Space Bar

Figure 2-4. Saving the Definitions

GENERAL Menu

GENERAL Menu

Figure 2-5 and Figure 2-6 show the GENERAL menu. Figure 2-7 on page 2-23 explains the setup parameters, their possible values, and their meanings.

S E T U P M E N U			
GENERAL	COMMUNICATION	KEYBOARD/PRINTER	FUNCTION
Machine Mode	IBM 3151	Forcing Insert	OFF
Screen	NORMAL	Tab	FIELD
Row and Column	24 x 80		
Scroll	JUMP		
Auto LF	ON		
CRT Saver	OFF	Term.ID _____	
Line Wrap	ON		

Figure 2-5. GENERAL Menu (IBM 3151 and IBM 3101)

S E T U P M E N U			
GENERAL	COMMUNICATION	KEYBOARD/PRINTER	FUNCTION
Machine Mode	TVI925E/925		
Screen	NORMAL		
Row and Column	24 x 80	Enhanced Mode	OFF
Scroll	JUMP	Edit Mode	DUPLEX
Auto LF	OFF	Attribute	SCREEN
CRT Saver	OFF		
Line Wrap	ON		

Figure 2-6. GENERAL Menu (Ten ASCII Terminals)

Note: If you change the machine mode in this menu, the machine mode is immediately saved. Setup-value definitions in use are replaced with the ones for the new machine mode.

GENERAL Menu

Setup Parameters	Possible Values	Meanings
Machine Mode	IBM 3151 IBM 3101 ADM 3A ADM 5 ADDS VP A2 HZ1500 TVI910+/910 TVI925E/925 TVI920/912	The display station operates in the selected machine mode. Ten ASCII terminals are ADM 3A, ADM 5, ADDS VP A2, HZ1500, TVI910, TVI910+, TVI925 TVI925E, TVI912, and TVI920. <i>Note:</i> Machine modes are classified into three groups; IBM 3151, IBM 3101, and ten ASCII terminals. If the machine mode is changed to a new machine mode in a different group, setup-value definitions that are in use are replaced with the ones for the new machine modes and the power-on reset (except the checking of the internal circuits) is performed. If the machine mode group is changed in the setup menu, the setup menu for the new machine mode is displayed.
Screen	NORMAL	The whole screen is displayed in normal video.
	REVERSE	The whole screen is displayed in reverse video.
Row and Column	24 x 80 25 x 80 24 x 132 25 x 132	The display station uses a screen size based on the selected rows and columns. The contents of the screen are cleared when the value is changed.
Scroll	JUMP	For example, when the last character of the last line is entered or received, all lines move up rapidly.
	SMOOTH F	For example, when the last character of the last line is entered or received, all lines move up slowly (faster than SMOOTH S).
	SMOOTH S	For example, when the last character of the last line is entered or received, all lines move up slowly (slower than SMOOTH F).
	NO	For example, when the last character of the last line is entered or received, no lines move up.

Figure 2-7 (Part 1 of 4). Setup Parameters in the GENERAL Menu

GENERAL Menu

Setup Parameters	Possible Values	Meanings
Auto LF	ON	<p>When the New Line option in the KEYBOARD/PRINTER menu is CR and the <i>Return</i> key is pressed, or the CR (carriage return) character is received, the cursor moves to the first position of the next line.</p> <p>When the New Line option in the KEYBOARD/PRINTER menu is CR/LF and the <i>Return</i> key is pressed, the cursor moves to the first position of the line after the next line.</p>
	OFF	<p>When the New Line option is CR and the <i>Return</i> key is pressed, or the CR character is received, the cursor moves to the first position of the current line.</p> <p>When the New Line option is CR/LF and the <i>Return</i> key is pressed, the cursor moves to the first position of the next line.</p>
CRT Saver	ON OFF	When ON is selected, the screen goes blank if no data is received from the host system or entered from the keyboard for 15 minutes. When data is received or entered and this function is active, the screen displays the data again. This function extends the life of the CRT.
Line Wrap	ON	<p>When the last character of the current line is entered or received, the cursor moves to the first position of the next line.</p> <p><i>Note:</i> In block mode or in a formatted page, ON is assumed regardless of the Line Wrap setting.</p>
	OFF	When the last character of the current line is entered or received, the cursor stays at the last position. The additional character is written over the last character.

Figure 2-7 (Part 2 of 4). Setup Parameters in the GENERAL Menu

GENERAL Menu

Setup Parameters	Possible Values	Meanings
Forcing Insert	OFF	If there is no space to insert a character or insert a null line, an insert operation cannot be done.
	LINE	If there is no space to insert a null line and an insert line operation is requested (for example, by the <i>Ins Ln</i> key), the current line is replaced with a null line and the remaining lower lines and the previous current line move down one line. The bottom line is then discarded.
	CHARACTER	If there is no space to insert a character and an insert character operation is requested (for example, by the <i>Insert</i> key), a character can be inserted at the cursor position. However, the last character of the current line is discarded when the Line Wrap option is OFF, or the last character in the page (or the field in a formatted page) is discarded when the Line Wrap option is ON.
	BOTH	Enables the LINE and CHARACTER functions.
Tab	FIELD	In a formatted page, the tab stops provided by the field attribute characters are used regardless of the column-tab definitions.
	COLUMN	The column-tab stops are used while ignoring the field attribute characters.
Enhance Mode	ON	Enables the enhanced commands. See <i>IBM 3151 ASCII Display Station Reference Manual</i> for more information.
	OFF	Disables the enhanced commands. See <i>IBM 3151 ASCII Display Station Reference Manual</i> for more information.
Edit Mode	DUPLEX	Key codes are generated and sent to the host system when any edit key (such as <i>Char Delete</i>) is pressed.
	LOCAL	Key codes are not generated when the edit keys are pressed. In this mode, you can edit text using the edit keys without sending the key codes to the host system.

Figure 2-7 (Part 3 of 4). Setup Parameters in the GENERAL Menu

GENERAL Menu

Setup Parameters	Possible Values	Meanings
Attribute	SCREEN	Field attributes are effective for the whole screen.
	LINE	Field attributes are effective for the current line.
Term.ID	Up to 20 characters	The terminal ID (identification) is used by the host system to identify the display station.

Figure 2-7 (Part 4 of 4). Setup Parameters in the GENERAL Menu

COMMUNICATION Menu

COMMUNICATION Menu

Figure 2-8 and Figure 2-9 show the COMMUNICATION menu. Figure 2-10 on page 2-28 explains the setup parameters, their possible values, and their meanings.

S E T U P M E N U			
GENERAL	COMMUNICATION	KEYBOARD/PRINTER	FUNCTION
Operating Mode	BLOCK		
Line Speed (bps)	9600	Line Control	PRTS
Word Length (bits)	7	Break Signal (ms)	500
Parity	ODD	Send Null Suppress	ON
Stop Bit	1	Pacing ¹	OFF
Turnaround Character	ETX		

Figure 2-8. COMMUNICATION Menu (IBM 3151 and IBM 3101)

S E T U P M E N U			
GENERAL	COMMUNICATION	KEYBOARD/PRINTER	FUNCTION
Operating Mode	ECHO		
Line Speed (bps)	9600	Line Control	IPRTS
Word Length (bits)	8		
Parity	NO		
Stop Bit	1	Pacing	OFF
Turnaround Character	CR	Parity Check	OFF

Figure 2-9. COMMUNICATION Menu (Ten ASCII Terminals)

¹ The **Pacing** option does not appear when you select the IBM 3151 machine mode.

COMMUNICATION Menu

Setup Parameters	Possible Values	Meanings
Operating Mode	BLOCK	Data in the specified area is sent to the host system. This mode allows the operator to edit the data before sending it to the host system.
	ECHO	Data entered from the keyboard is sent only to the host system. The host system then returns the data to the IBM 3151 for display on the screen.
	CHAR	Data entered from the keyboard is sent to the host system and at the same time displayed on the screen.
Line Speed	See page 2-36 or 2-37.	The display station sends data to or receives data from the host system at the selected line speed (bps).
Word Length	7 8	The display station uses the selected word length (7-bit or 8-bit).
Parity	ODD EVEN NO SPACE MARK	The display station uses the selected parity. Parity is not added when NO is selected. The IBM 3151 ignores a parity error when SPACE or MARK is selected.
Stop Bit	1 2	The display station places one or two bits after each data character.
Turnaround Character	ETX CR EOT DC3	<p>The display station generates an ETX (end of text), CR (carriage return), EOT (end of transmission), or DC3 (device control 3) character after each data stream when:</p> <ul style="list-style-type: none"> • A read operation is requested from the host system • One of the Send, Send Line, Sn Msg, Function, PA, and Clear keys is pressed • The Reset key is pressed when the reset key attention is enabled • One of the Print, Print Line, Pr Msg keys is pressed when the print key attention is enabled. • DC3 is only available in IBM 3151 and IBM 3101 modes. When DC3 is selected, Pacing option is assumed to be disabled.

Figure 2-10 (Part 1 of 2). Setup Parameters in the COMMUNICATION Menu

COMMUNICATION Menu

Setup Parameters	Possible Values	Meanings
Line Control	PRTS	The display station controls the RS-232C signal line using PRTS (permanent request to send). In this mode, RTS (request to send) is always set to ON, and CTS (clear to send) and DSR (data set ready) are monitored to check the modem status.
	IPRTS	The display station controls the RS-232C signal line using IPRTS (induced permanent request to send). In this mode, RTS is always set to ON, and CTS and DSR are always assumed ON.
	CRTS	The display station controls the RS-232C signal line using the CRTS (controlled request to send). CRTS looks at the CTS, DSR and CD (carrier detect) signals to determine the status of the display station. The display station enters <i>sending mode</i> when the CD signal is off or enters <i>receiving mode</i> when the CD signal is on.
Break Signal	500	The display station sends a 500 ms break signal to the host system when the <i>Break</i> key is pressed.
	170	The display station sends a 170 ms break signal to the host system when the <i>Break</i> key is pressed.
Send Null Suppress	ON	The trailing null characters are not sent to the host system.
	OFF	The trailing null characters are replaced with space characters and sent to the host system.
Pacing	ON OFF	When ON is selected and the receiving buffer of the display station becomes almost full, the display station sends the XOFF character to the host system. If the XOFF condition is removed, the display station sends the XON character to the host system. If the line turnaround character DC3 is selected, this option is disabled.
Parity Check	ON OFF	When ON is selected, parity is checked. If a parity error is detected, symbol ? is displayed on the screen.

Figure 2-10 (Part 2 of 2). Setup Parameters in the COMMUNICATION Menu

KEYBOARD/PRINTER Menu

KEYBOARD/PRINTER Menu

Figure 2-11 and Figure 2-12 show the KEYBOARD/PRINTER menu. Figure 2-13 on page 2-31 explains the setup parameters, their possible values, and their meanings.

S E T U P M E N U			
GENERAL	COMMUNICATION	KEYBOARD/PRINTER	FUNCTION
KEYBOARD		PRINTER	
Enter ²	RETURN	Line Speed (bps)	9600
Return	FIELD	Word Length (bits)	7
New Line	CR	Parity	ODD
Send	PAGE	Stop Bit	1
Insert Character	MODE	Characters ²	NATIONAL

Figure 2-11. KEYBOARD/PRINTER Menu (IBM 3151 and IBM 3101)

S E T U P M E N U			
GENERAL	COMMUNICATION	KEYBOARD/PRINTER	FUNCTION
KEYBOARD		PRINTER	
		Line Speed (bps)	1200
		Word Length (bits)	8
		Parity	NO
		Stop Bit	1
Lock Command	ENABLE		

Figure 2-12. KEYBOARD/PRINTER Menu (Ten ASCII Terminals)

² The **Enter** and **Character** options do not appear when the IBM 3151 Model 11 is used.

KEYBOARD/PRINTER Menu

Setup Parameters	Possible Values	Meanings
Enter	RETURN	The <i>Enter</i> key works as the <i>Return</i> key.
	SEND	The <i>Enter</i> key works as the <i>Send</i> key.
Return	FIELD	The functions specified in the New Line option are performed when the <i>Return</i> key is pressed. However, if the target line is within a protected field, the cursor moves to the first character position of the next unprotected field.
	NEW LINE	The functions specified in the New Line option are performed when the <i>Return</i> key is pressed.
New Line	CR	A CR (carriage return) character is generated when the <i>Return</i> key is pressed.
	CR/LF	Both the CR and LF (line feed) characters are generated when the <i>Return</i> key is pressed.
Send	PAGE	The display station sends the contents of the current page to the host system when the <i>Send</i> key is pressed or sends the current line to the host system when the <i>Send Line</i> key is pressed.
	LINE	The display station sends the contents of the current line to the host system when the <i>Send</i> key is pressed or sends the contents of the current page to the host system when the <i>Send Line</i> key is pressed.
Insert Character	MODE	The display station enters insert mode when the <i>Insert</i> key is pressed.
	SPACE	A space character is inserted after the current cursor position when the <i>Insert</i> key is pressed.
Lock Command	ENABLE	Keyboard lock/unlock commands are honored and performed.
	DISABLE	Keyboard lock/unlock commands are ignored and no operation is performed.

Figure 2-13 (Part 1 of 2). Setup Parameters in the KEYBOARD/PRINTER Menu

KEYBOARD/PRINTER Menu

Setup Parameters	Possible Values	Meanings
Line Speed	See page 2-36 or 2-37.	The display station receives data from or sends data to an optional device on the auxiliary port at the selected line speed (bps).
Word Length	7 8	The display station uses the selected word length (7-bit or 8-bit).
Parity	ODD EVEN NO SPACE MARK	The display station uses the selected parity. Parity is not added when NO is selected. The IBM 3151 ignores a parity error when SPACE or MARK is selected.
Stop Bit	1 2	The display station places one or two bits after each data character.
Characters	NATIONAL	The display station sends the alphanumeric characters (ASCII graphic characters) to the printer (optional device) when a print operation is requested. Other characters, such as the control characters, are replaced with the space characters and sent to the printer.
	ALL	The display station sends all characters (with control information to select the character set or character attribute, if necessary) to the printer (optional device) when a print operation is requested. If the printer can handle such information, all characters can be printed correctly (reverse, or underscore may be handled differently).

Figure 2-13 (Part 2 of 2). Setup Parameters in the KEYBOARD/PRINTER Menu

FUNCTION MENU

FUNCTION Menu

Figure 2-14 and Figure 2-15 show the FUNCTION menu. Figure 2-16 on page 2-34 explains each function.

The IBM 3151 has two storage areas for saving the setup-value definitions; VM (volatile memory) and NVM (non-volatile memory). The contents of VM are lost when the power is turned off; the contents of NVM are retained.

When you power-on the IBM 3151 for the first time, NVM contains no values and initial setup-value definitions are created internally in the display and stored in VM. These are called *default* values and are used unless you redefine them.

S E T U P M E N U			
GENERAL	COMMUNICATION	KEYBOARD/PRINTER	FUNCTION
Recall	Save	Default	
Reset Terminal			

Figure 2-14. FUNCTION Menu (IBM 3151 and IBM 3101)

S E T U P M E N U			
GENERAL	COMMUNICATION	KEYBOARD/PRINTER	FUNCTION
Recall	Save	Default	
Reset Terminal	Clear Status	Mode Adjust	

Figure 2-15. FUNCTION Menu (Ten ASCII Terminals)

FUNCTION MENU

If you select this field and press the space bar	this will occur
Recall	The contents of NVM (non-volatile memory) are copied to VM (volatile memory). When the Machine Mode or Operating Mode option is changed, "Reset Terminal" is also performed. When the Row and Column option is changed, the screen is cleared.
Save	The setup-value definitions defined now and saved in VM are also saved in NVM.
Default	The setup-value definitions (except the machine mode and terminal ID) are copied to VM. The values depend on the machine modes. Refer to Figure 2-18 on page 2-36 and Figure 2-19 on page 2-37 for more details. When the Machine Mode or Operating Mode option is changed, "Reset Terminal" is also performed. When the Row and Column option is changed, the screen is cleared.
Reset Terminal	The contents of NVM are copied to VM and the power-on reset (except checking the internal circuits) is performed.
Clear Status	<ul style="list-style-type: none">• The internal receiving queues for the main and auxiliary ports are cleared.• Print mode is set to the page print mode.• Hold-screen status is reset.• Keyboard-lock condition is reset.• Reset write protect and protect modes.• All data transmissions are canceled.• XOFF condition for both the main and auxiliary ports are cleared.• DTR history at auxiliary port is cleared.
Mode Adjust	Some setup values are set to the predefined values (defined by the terminal you want to emulate). Which values are affected depend on the machine mode (see Figure 2-17 on page 2-35). Setup-value definitions in NVM are not affected.

Figure 2-16. Functions in the FUNCTION Menu

FUNCTION MENU

	ADM 3A	ADM 5	ADDS VP A2	HZ1500	TVI910 TVI910 +	TVI925 TVI925E	TVI912 TVI920
Attribute	-	LINE	-	-	LINE	-	-
Auto LF	OFF	OFF	-	-	-	-	-
Default Turnaround Char	-	-	-	-	CR	CR	CR
Enhance Mode	OFF	OFF	OFF	OFF	OFF	OFF	OFF
Line Wrap	-	-	ON	ON	ON	ON	ON
Pacing	OFF	OFF	OFF	OFF	-	-	-
Row and Column	24 x 80	24 x 80	24 x 80	24 x 80	24 x 80	24 x 80	24 x 80
Scroll	JUMP	JUMP	-	JUMP	JUMP	JUMP	JUMP

Figure 2-17. Setup-Value Definitions Set by Mode Adjust Function

Setup Parameters List

Circle the selected value for each parameter in the following list. This information will be the source used to define the setup values.

GENERAL	
Machine Mode	IBM 3151* IBM 3101**
Screen	NORMAL* REVERSE
Row and Column	24 x 80* 25 x 80 24 x 132** 25 x 132**
Scroll	JUMP* SMOOTH F SMOOTH S** NO
Auto LF	ON* OFF
CRT Saver	OFF* ON
Line Wrap	ON* OFF
Forcing Insert	OFF* LINE CHARACTER BOTH
Tab	FIELD* COLUMN
Term.ID (up to 20 characters)	_____
COMMUNICATION	
Operating Mode	BLOCK* ECHO CHAR
Line Speed (bps)	50 75 110 134.5 150 200 300 600 1200 1800 2400 3600 4800 9600* 19200 38400
Word Length (bits)	7* 8
Parity	ODD* EVEN NO SPACE MARK
Stop Bit	1* 2
Turnaround Character	ETX* CR EOT DC3***
Line Control	PRTS* IPRTS CRTS
Break Signal (ms)	500* 170
Send Null Suppress	ON* OFF
Pacing†	OFF* ON
KEYBOARD/PRINTER	
Enter**	RETURN* SEND
Return	FIELD* NEW LINE
New Line	CR* CR/LF
Send	PAGE* LINE
Insert Character	MODE* SPACE
Line Speed (bps)	50 75 110 134.5 150 200 300 600 1200 1800 2400 3600 4800 9600* 19200
Word Length (bits)	7* 8
Parity	ODD* EVEN NO SPACE MARK
Stop Bit	1* 2
Characters**	NATIONAL* ALL
* Indicates the default values (same values as set in the factory).	
** IBM 3151 Models 31 and 41 only.	
*** When DC3 is selected, Pacing option is assumed to be disabled.	
† The Pacing option applies only to IBM 3101 emulation mode; it is always set to on in IBM 3151 mode.	

Figure 2-18. Setup Parameters and Their Possible Values (IBM 3151 and IBM 3101)

Setup Parameters List

GENERAL	
Machine Mode	ADM 3A ADM 5 ADDS VP A2 HZ1500 TVI910+ /910 TVI925E/925* TVI920/912
Screen	NORMAL* REVERSE
Row and Column	24 x 80* 25 x 80 24 x 132** 25 x 132**
Scroll	JUMP* SMOOTH F SMOOTH S** NO
Auto LF	OFF* ON
CRT Saver	OFF* ON
Line Wrap	ON* OFF
Enhance Mode	OFF* ON
Edit Mode†	DUPLEX* LOCAL
Attribute	SCREEN* LINE
COMMUNICATION	
Operating Mode	ECHO* CHAR BLOCK
Line Speed (bps)	50 75 110 134.5 150 200 300 600 1200 1800 2400 3600 4800 9600* 19200 38400
Word Length (bits)	8* 7
Parity	NO* SPACE MARK ODD EVEN
Stop Bit	1* 2
Turnaround Character	CR* EOT ETX
Line Control	IPRTS* CRTS PRTS
Pacing	OFF* ON
Parity Check	OFF* ON
KEYBOARD/PRINTER	
Lock Command	ENABLE* DISABLE
Line Speed (bps)	50 75 110 134.5 150 200 300 600 1200* 1800 2400 3600 4800 9600 19200
Word Length (bits)	8* 7
Parity	NO* SPACE MARK ODD EVEN
Stop Bit	1* 2
* Indicates the default values (same values as set in the factory).	
** IBM 3151 Models 31 and 41 only.	
† The Edit Mode applies only modes that emulate six TVI terminals.	

Figure 2-19. Setup Parameters and Their Possible Values (Ten ASCII Terminals)

Defining Function Keys

Defining Function Keys

Note: This section describes functions of the IBM 3151 Models 31 and 41. Some functions are not available for the IBM 3151 Model 11. See Figure 1-2 on page 1-2 for more details.

You can redefine function keys *F1* through *F36* from the keyboard or by a host command. *F13* through *F24* are selected when the respective key is pressed with the *Shift* key. *F25* through *F36* are selected when the respective key is pressed with the *Shift* key and the *Ctrl* key. ESC (escape) sequences, ASCII control characters, or character strings can be assigned to each function key. ASCII control characters can be entered by pressing a selected alphanumeric key while holding down the *Ctrl* key. If you do not redefine a function key, the associated key code is generated when the function key is pressed.

Figure 2-20 shows the locations of the keys used for this step.

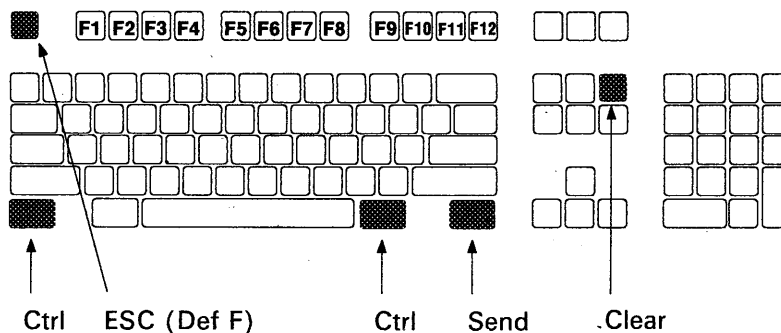

Figure 2-20. Keys Used for Defining Function Keys

The next page shows how you can define function keys using the *Def F* key.

Defining Function Keys

a

Press and hold the *Ctrl* key; then press the *Def F* key.

The function key menu will appear as shown below.

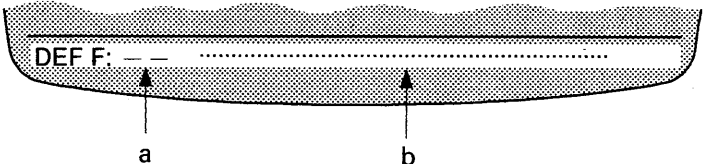

- a:** A two-digit number (01 through 36) of a function key is entered here.
- b:** The function is entered here (up to 64 characters for Models 31 and 41; up to 32 characters for Model 11).

b

In area **a**, type a two-digit key number and press the *Send* key.

For example, suppose you want to display (or send) **Dear Sir**, at the cursor position and perform a carriage return when you press the *F1* key; type 01 in area **a**.

The menu will change as follows: (The IBM-supplied default setting of the key code format is displayed.)

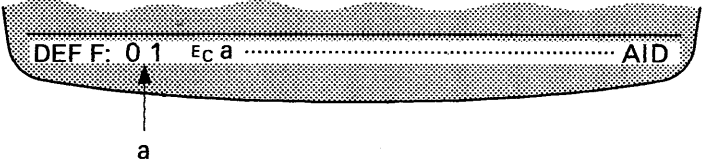

Defining Function Keys

c

In area **b**, type one or more ESC sequences or a character string.

In this case, type **Dear Sir**, and enter the CR character (generated by pressing the *M* key while holding down the *Ctrl* key. See *IBM 3151 ASCII Display Station Reference Manual* for more information.)

The bottom of the screen should look like this.

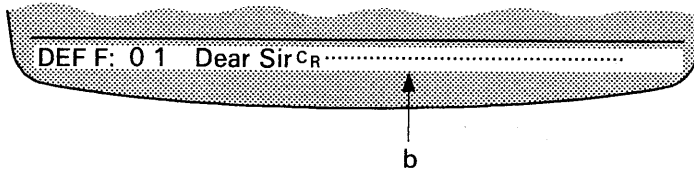

d

Press the *Send* key to store the redefined key.

The bottom of the screen should now be:

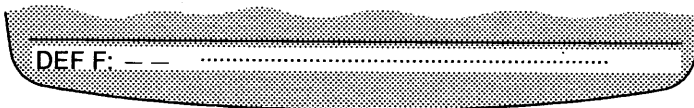

Repeat steps **b** through **d** (pages 2-39 and 2-40) until you have defined all necessary function keys.

e

To exit this mode, press and hold the *Ctrl* key; then press the *Def F* key.

Defining Function Keys

Notes:

1. *The display station can store up to 512 characters for all function-key definitions. This is accomplished by pressing the **Send** key at step **d**. If the total exceeds 512, overflow characters are discarded, and area **a** will blink at step **d**.*

*If you do not want to save the definition, press the **Def F** key while holding down the **Ctrl** key instead of pressing the **Send** key at step **d**.*

2. *If you press the **Clear** key when the cursor is located in area **b**, the field is set with the default value.*
3. *•••• in the menu shows the null characters. The trailing null characters are removed from the definition.*

Defining Function Keys

Keyboard Functions

Chapter 3. Understanding the Keyboard Functions

This chapter describes the function of each key. Figure 3-1 shows the layout of the IBM 3151 keyboard. The keyboard includes alphanumeric keys, numeric keypad keys, and control-function keys. Shaded keys are the control-function keys.

The keyboard without the numeric keypad is also available. However, you cannot use some keyboard functions (such as line drawing) with this keyboard. See “Keyboard Without Numeric Keypad” on page 3-17 for more information.

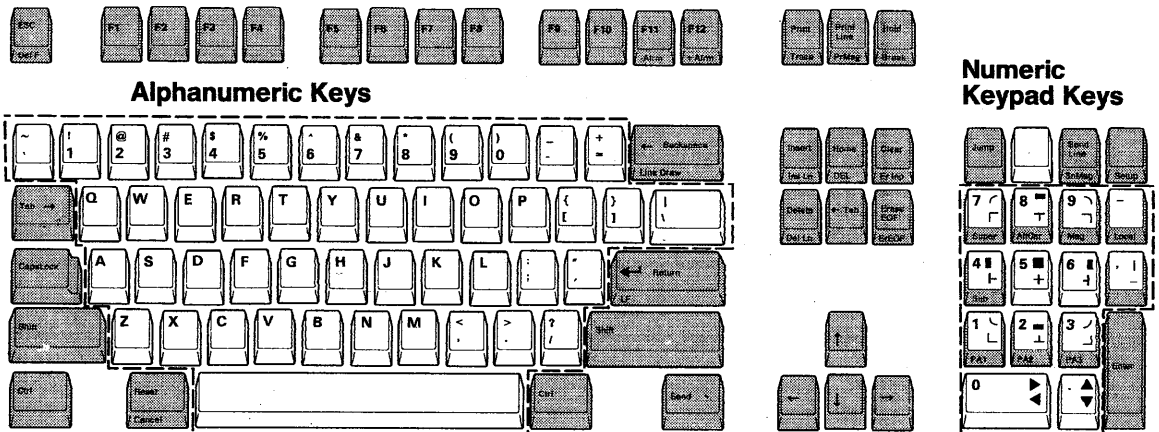

Figure 3-1. IBM 3151 Keyboard

Keyboard Functions

Alphanumeric Keys

Are used for entering:

- Alphabetic characters (A through Z, a through z)
- Numeric characters (0 through 9)
- Punctuation marks (such as , ; : ? !)
- Symbols (such as @ % \$).

As on an ordinary typewriter, these keys repeat when they are pressed and held down.

Numeric Keypad Keys

Are used for entering:

- Numeric characters
- Punctuation marks (- , .)
- Superscripts (⁰ through ⁹)
- Subscripts (₀ through ₉)
- Line-drawing symbols (such as ► and ▲).

These keys, except the superscript and subscript keys, repeat when they are pressed and held down.

Key Index

Key	Page
Alarm (+ Alm, - Alm).....	3-4
Alternate Cursor (Alt Csr).....	3-5
Backspace (← Backspace).....	3-5
Back Tab (← Tab).....	3-15
Break.....	3-5
Cancel.....	3-5
Caps Lock.....	3-6
Clear.....	3-6

Keyboard Functions

Control (Ctrl)	3-6
Cursor Move (↑ ← ↓ →)	3-6
Define Function (Def F)	3-7
DEL	3-7
Delete	3-7
Delete Line (Del Ln)	3-7
Enter	3-8
Erase Input (Er Inp)	3-8
Erase to End of Field (Erase EOF)	3-8
Erase to End of Page (ErEOP)	3-9
Escape (ESC)	3-9
Function (F1-F12)	3-9
Hold Screen (Hold)	3-10
Home	3-10
Insert	3-10
Insert Line (Ins Ln)	3-10
Jump Partition (Jump)	3-11
Line Feed (LF)	3-11
Line Draw	3-11
Local	3-11
Message (Msg)	3-12
Print	3-12
Print Line	3-12
Print Message (Pr Msg)	3-12
Program Access (PA1-PA3)	3-13
Reset	3-13
Return	3-13
Send	3-13
Send Line	3-14
Send Message (Sn Msg)	3-14
Setup	3-14
Shift	3-14
Subscript (Sub)	3-15
Superscript (Super)	3-15
Tab (Tab →)	3-15
Trace	3-16

Keyboard Functions

What Each Key Does

This section describes the function of each *control-function* key for the IBM 3151 Models 31 and 41. Some control-function keys are not available for the IBM 3151 Model 11. See Figure 1-2 on page 1-2 for more details. Throughout this section, the left column shows an illustration of each key and the right column explains the function of the non-shaded part of the key. The function labeled on the top of the key is performed when the key is pressed alone. The function labeled on the front of the key is performed when the key is pressed while holding down the *Ctrl* key.

The functions of some keys depend on the option settings of host commands or setup-value definitions. See *IBM 3151 ASCII Display Station Reference Manual* for more information.

KEY	FUNCTION
-----	----------

- Alarm





Decreases the sound of the audible alarm (the setting is saved for later use).

+ Alarm

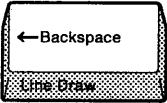

Increases the sound of the audible alarm (the setting is saved for later use).

Keyboard Functions

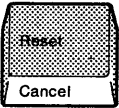
KEY	FUNCTION
<p>Alternate Cursor</p> 	<p>Selects among four cursor types: block, blinking bar, blinking block, and bar. The selected cursor type is saved and used the next time power is turned on.</p>
<p>← Backspace</p> 	<p>Moves the cursor to the left one position at a time.</p>
<p>Break</p> 	<p>Generates the break signal when the display station (1) uses PRTS or IPRTS for the line control and RS-232C for the interface or (2) operates in echo mode.</p> <p>Using this key, you can cause the host system to wait before it sends data to the display station.</p>
<p>Cancel</p> 	<p>Ends data transfer to the host system or the optional device on the auxiliary port. Also resets the "KEYS LOCKED," "AUX NOT READY," or "AUX BUSY" conditions.</p> <p>Using this key, you can cancel either the print operation or the data transmission to the host system.</p>

Keyboard Functions

KEY

FUNCTION

Caps Lock

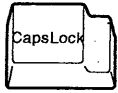

Locks the keyboard in up-shift (for alphabetic keys only) mode. Pressing this key again resets up-shift mode.

Clear

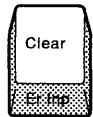

Erases all characters in the active page where the cursor is located, and moves the cursor to the first position of the page.

Also clears the field attributes and the tab stops, and resets insert mode.

Control

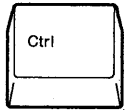

Selects the function indicated on the front of the other selected keys.

Cursor Move

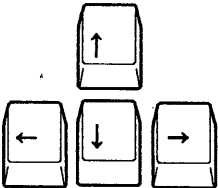

Moves the cursor in the direction of the arrow.

Keyboard Functions

KEY

FUNCTION

Define Function

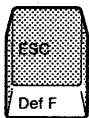

Enters define-function key mode. See "Defining Function Keys" on page 2-38 on how to define function keys.

DEL



In character or echo mode, the display station sends an ASCII DEL character to the host system.

Delete

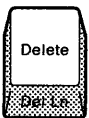

Deletes the character in an unprotected field or in an unformatted page at the current cursor position. If the cursor is located at an attribute character or in a protected field, the audible alarm sounds and WRONG PLACE appears at the bottom of the screen.

Delete Line



Deletes the line where the cursor is located. If an attribute character exists in the current line, or if the current field is protected, the audible alarm sounds and WRONG PLACE appears at the bottom of the screen.

Keyboard Functions

KEY

FUNCTION

Enter

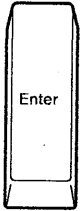

Works as the *Send* key when SEND is selected or works as the *Return* key when RETURN is selected for the Enter option.

Erase Input



Erases all characters in the active page and moves the cursor to the first position when the page is unformatted.

Erases all unprotected characters in the active page and moves the cursor to the first position of the first unprotected field when the page is formatted.

Erase to End of Field



Erases all characters from the cursor position to the end of the line when the page is unformatted.

Erases all characters from the cursor position to the end of the line or to the end of the field, whichever comes first, when the page is formatted.

If the cursor is located at a field attribute character or in a protected field, the audible alarm sounds and WRONG PLACE appears at the bottom of the screen.

Keyboard Functions

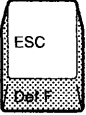
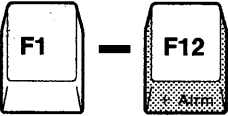
KEY	FUNCTION
Erase to End of Page 	<p>Erases all characters from the cursor position to the end of the page when the page is unformatted.</p> <p>Erases all unprotected characters from the cursor position to the end of the page when the page is formatted.</p>
Escape 	<p>Generates an ASCII ESC character.</p> <p>The ESC character followed by appropriate alphanumeric characters forms an ESC sequence, which provides unique IBM 3151 functions in addition to the standard ASCII control functions.</p>
Function (F1 - F12) 	<p>Sends an ESC sequence to the host system or generates a character string that is assigned to each function key. Works as F13 through F24 when pressed with the <i>Shift</i> key. Works as F25 through F36 when pressed with both the <i>Shift</i> and <i>Ctrl</i> keys. See "Defining Function Keys" on page 2-38 for defining function keys.</p> <p>If you have not redefined a function key, the default ESC sequence is generated.</p>

Keyboard Functions

KEY

FUNCTION

Hold Screen



Stops the screen from being updated by the host system during normal operation. The incoming data will be stored in the display station. If the display station's data buffer becomes almost full, an XOFF character will be sent to the host system.

Pressing this key again starts the screen update operation.

Home



Moves the cursor to the home position (first unprotected character position) of the active page.

Insert

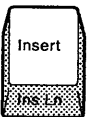

Places the keyboard in insert mode and allows characters to be inserted in a field when MODE is selected, or inserts a space character when SPACE is selected for the Insert Character option. Pressing this key again or pressing the *Reset* key exits insert mode.



If there is no space to insert a character (when the Forcing Insert option is OFF) or the cursor is in a protected field, the audible alarm sounds and WRONG PLACE appears at the bottom of the screen.

Insert Line

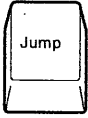
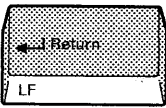
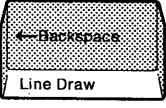

Inserts a null line where the cursor is located. If there is no space to insert a line (when the Forcing Insert option is OFF), or the cursor is in a protected field, or an attribute character exists in the current line, the audible alarm sounds and WRONG PLACE appears at the bottom of the screen.

Keyboard Functions

KEY	FUNCTION
<p>Jump Partition</p>  A rectangular key with the word "Jump" printed in the center.	Moves the cursor to the next partition.
<p>Line Feed</p>  A rectangular key with a left-pointing arrow and the word "Return" above it, and "LF" below it.	Moves the cursor to the first character of the next line when New Line is selected, or moves the cursor to the same position of the next line when Line Feed is selected for the ASCII LF Character option (Set Control 3 command).
<p>Line Draw</p>  A rectangular key with a left-pointing arrow and the word "Backspace" above it, and "Line Draw" below it.	<p>Enters line-drawing mode. Enables the numeric keypad for line drawing. Pressing this key again exits this mode.</p> <p>The line-drawing symbols are unique to the IBM 3151. They are on the right half of the numeric keypad keys. By pressing the <i>Line Draw</i> key while holding down the <i>Ctrl</i> key, the display station enters line-drawing mode. You can then use these symbols for drawing lines and making tables.</p>
<p>Local</p>  A rectangular key with the word "Local" printed in the center.	Enters local mode, in which almost all communications with the host system are disabled. Pressing this key again exits local mode.

Keyboard Functions

KEY	FUNCTION
-----	----------

Message

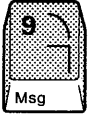

Each time the *Msg key* is pressed, the contents of the operator information area (OIA) change. At first the OIA contains no indicators; the first time the *Msg key* is pressed, operator messages appear; the next time the *Msg key* is pressed, host messages appear. The state of the OIA which is currently in use is saved (except host message) for later use.

Print

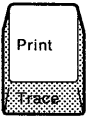

Sends the contents of the current page to the optional device on the auxiliary port. Sends the contents of the screen when pressed together with the *Shift key* (this function is only available for Models 31 and 41.) The data to be sent depends on the Characters option. See page 2-32 for more information. Sends the key code to the host system if the print key attention is enabled.

Print Line

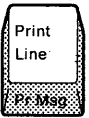

Sends the contents of the current line to the optional device on the auxiliary port. The data to be sent depends on the Characters option. See page 2-32 for more information. Sends the key code to the host system if the print key attention is enabled.

Print Message



In block mode, the display station sends data from the line below the send mark (⏏) to the cursor position, to the optional device on the auxiliary port. The send mark can be specified by pressing the *ESC key*; then pressing the *E key* while holding down the *Shift key*. If no send mark is specified, data from the top of the screen to the cursor position is sent. The data to be sent depends on the Characters option. See page 2-32 for more information. Sends the key code to the host system if the print key attention is enabled.

Keyboard Functions

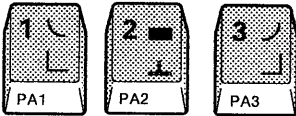
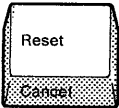
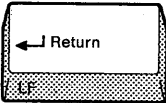
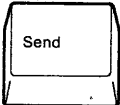
KEY	FUNCTION
<p>Program Access</p> 	<p>Sends one of the following ESC sequences to the host system:</p> <ul style="list-style-type: none">ESC ! m (PA1)ESC ! n (PA2)ESC ! o (PA3)
<p>Reset</p> 	<p>Resets superscript, subscript, and insert modes. Also removes the error indications displayed at the bottom of the screen.</p> <p>Sends the key code to the host system if the reset key attention is enabled.</p>
<p>Return</p> 	<p>Moves the cursor to the first character of (1) the current line, (2) the next line, or (3) the line after the next line, depending on the AUTO LF and NEW LINE options.</p>
<p>Send</p> 	<p>In block mode, the display station sends the contents of the active page to the host system when PAGE is selected, or sends the contents of the current line to the host system when LINE is selected for the Send option. The data to be sent depends on the Send Data Format option.</p> <p>In character or echo mode, the display station does not perform the above function, but sends the key code to the host system.</p>

Keyboard Functions

KEY

FUNCTION

Send Line



In block mode, the display station sends the contents of the current line to the host system when PAGE is selected, or sends the contents of the current page to the host system when LINE is selected for the Send option. The data to be sent depends on the Send Data Format option.

In character or echo mode, the display station does not perform the above function, but sends the key code to the host system.

Send Message



In block mode, the display station sends data from the line below the send mark () to the cursor position to the host system. The send mark can be specified by pressing the *ESC* key; then pressing the *E* key while holding down the *Shift* key. If no send mark is specified, data from the top of the screen to the cursor position is sent. The data to be sent depends on the Send Data Format option.

In character or echo mode, the display station does not perform the above function, but sends the key code to the host system.

Setup



Enters setup mode to define the setup values. See "Defining Setup Values" on page 2-14 for more information.

Shift

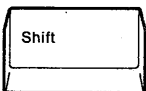

Enables keyboard up-shift.

Keyboard Functions

KEY

FUNCTION

Subscript

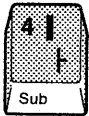

Allows subscripts (_{0 - 9}) to be entered when used together with the numeric keys.

Superscript

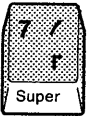

Allows superscripts (^{0 - 9}) to be entered when used together with the numeric keys.

Tab →

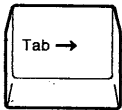

Moves the cursor to the next column tab stop when the page is unformatted.

Moves the cursor to the first character of the next unprotected field when FIELD is selected for the Tab option and the page is formatted. Moves the cursor to the next column tab when COLUMN is selected for the Tab option and the page is formatted.

Works as the ← Tab key when pressed with the *Shift* key.

← Tab (Back Tab)

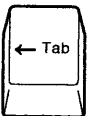

Performs the same operation as the Tab → key, except the direction (*previous* instead of next).

Keyboard Functions

KEY

FUNCTION

Trace

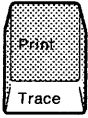

Enters trace mode. In trace mode, data from the host system is transferred to the optional device on the auxiliary port without data conversion while displaying the same data on the screen. Pressing this key again exits trace mode.

Keyboard Without Numeric Keypad

Figure 3-2 on page 3-18 shows the layout of the IBM 3151 keyboard without the numeric keypad. Some keyboard functions on the IBM 3151 numeric keypad keys are not available or are in a different location.

Note: This function does not apply to Ten ASCII terminals emulation mode.

Keyboard functions not available are:

- Line draw
- Super
- Sub
- Enter
- Jump
- PA1 - PA3.

Keyboard functions moved to a different location are:

- Setup
- Sn Msg
- Send Line
- Alt Csr
- Msg
- Local.

Additional keyboard function is:

- Num Lock.

Pressing the *Backspace* key while holding down the *Ctrl* key causes the display station to enter numeric lock mode. In this mode, you can use only numeric keys for data entries. See Figure 3-3 on page 3-18 for the available alphanumeric keys in numeric lock mode.

Keyboard Functions

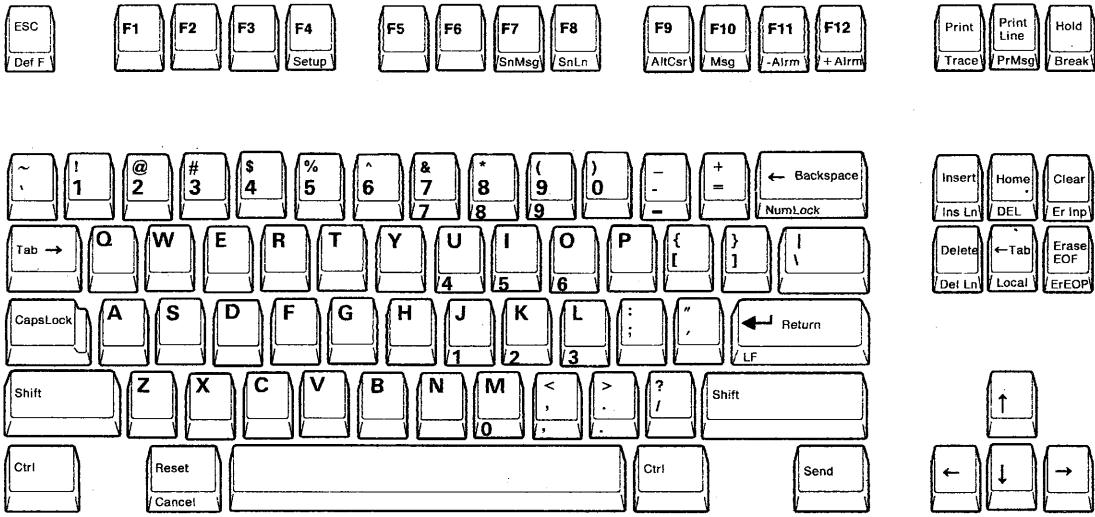

Figure 3-2. IBM 3151 Keyboard Without Numeric Keypad

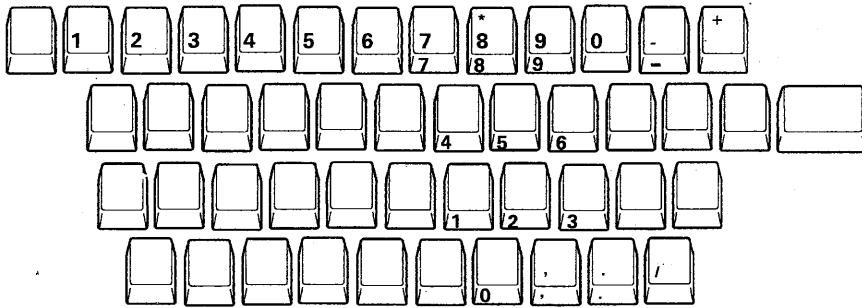

Figure 3-3. Available Alphanumeric Keys in Numeric Lock Mode

Chapter 4. Interpreting Operator Messages

This chapter describes the messages for the IBM 3151 Models 31 and 41 that are displayed at the bottom of the screen (operator information area). Some messages are not displayed on the IBM 3151 Model 11. See Figure 1-2 on page 1-2 for more details.

This area is used to display:

- The operating status of the display station
- The communication status
- Warning messages if a problem is detected
- Host messages.

Messages are displayed in predefined areas depending on their type. Figure 4-1 on page 4-3 shows the operator information area and Figure 4-2 on page 4-3 explains what the operator messages are, what they mean, and what action, if any, is required for each one.

Notes:

1. *The operator information area is not displayed when you power-on the display station the first time after installation. You can turn on the indication of this area by pressing the **Msg** key while holding down the **Ctrl** key.*
2. *Host messages sent from the host system can also appear in this area by replacing the previous indication. You can select the indication of this area, that is, to display the operator message or the host message, or to turn off the indication, using the **Msg** key.*

Operator Messages

3. *The operator information area is also used to display one-line menus for defining setup values and function keys.*
4. *If two or more messages exist in each area, the message with the higher priority is displayed. Messages in area 3 are displayed in the following order:*

In IBM 3151 and IBM 3101 mode

- a. PROBLEM IN VIDEO ELEMENT OR KEYBOARD
- b. PROBLEM IN KEYBOARD
- c. COMM NOT READY 2
- d. COMM NOT READY 1
- e. AUX NOT READY
- f. HOST BUSY
- g. AUX BUSY
- h. HOLD SCREEN
- i. SENDING
- j. RECEIVING
- k. PRINTING
- l. KEYS LOCKED
- m. INVALID KEY
- n. WRONG PLACE
- o. KEYBOARD ERROR
- p. NUMERIC

In emulation mode of Ten ASCII terminals

- a. PROBLEM IN VIDEO ELEMENT OR KEYBOARD
- b. PROBLEM IN KEYBOARD
- c. COMM NOT READY 2
- d. COMM NOT READY 1
- e. AUX NOT READY
- f. WAIT
- g. HOST BUSY
- h. AUX BUSY
- i. HOLD SCREEN
- j. SENDING
- k. PRINTING

Operator Messages

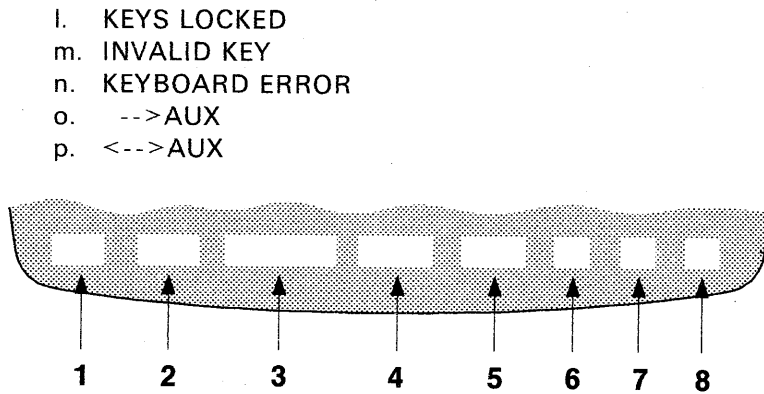

Figure 4-1. Operator Information Area

Area	Message	Meaning	Action
1	BLOCK CHAR ECHO LOCAL TEST	Shows the current operating mode.	None.
2	TRANSP	Shows that the display station is in transparent mode.	In IBM 3151 and IBM 3101 mode: To exit transparent mode, press the <i>P</i> key while holding down the <i>Ctrl</i> key; then press the <i>C</i> key while holding down the <i>Ctrl</i> key. In Ten ASCII terminals emulation mode: To exit transparent mode, press the <i>Trnsp</i> key while holding down the <i>Ctrl</i> key.

Figure 4-2 (Part 1 of 10). Operator Messages

Operator Messages

Area	Message	Meaning	Action
3	AUX BUSY	Appears when an XOFF condition occurs at the optional device on the auxiliary port.	<p>In IBM 3151 and IBM 3101 mode:</p> <p>Wait.</p> <p>This message disappears when the XOFF condition is removed.</p> <p><i>Note:</i> This message also disappears if you press the <i>Cancel</i> key, however any remaining data is discarded.</p> <p>In Ten ASCII terminals emulation mode:</p> <p>Wait.</p> <p>This message disappears when the display station receives an XON character or you perform Clear Status in the FUNCTION menu.</p>

Figure 4-2 (Part 2 of 10). Operator Messages

Operator Messages

Area	Message	Meaning	Action
3	AUX NOT READY	Appears when an operator or an application program tries to send data to the optional device on the auxiliary port while the optional device is not ready to operate (DTR signal of the optional device is off).	<p>In IBM 3151 and IBM 3101 mode:</p> <p>This message disappears when (1) the optional device becomes ready or (2) you press the <i>Cancel</i> key.</p> <p>Check the optional device (such as power) If the message appears again, see “Analysis Procedures” on page 5-15.</p> <p>In Ten ASCII terminals emulation mode:</p> <p>This message disappears (1) when the optional device becomes ready or (2) you perform Clear Status in the FUNCTION menu.</p> <p>Check the optional device. If the message appears again, see “Analysis Procedures” on page 5-15.</p>

Figure 4-2 (Part 3 of 10). Operator Messages

Operator Messages

Area	Message	Meaning	Action
3	COMM NOT READY 1	Appears when the CTS (clear to send) signal is not sent from the host system (or modem) while the DTR (data terminal ready) and RTS (request to send) signals are turned on and the DSR (data set ready) signal is present on the main port.	<ol style="list-style-type: none"> 1. Power off, then power on. 2. If the message reappears, see "Communication Problems" on page 5-19.
	COMM NOT READY 2	Appears when the DTR signal is turned on and the DSR signal is not present on the main port.	<ol style="list-style-type: none"> 1. Power off, then power on. 2. If the message reappears, see "Communication Problems" on page 5-19.
	HOLD SCREEN	Shows that the screen update is suspended when the <i>Hold</i> key is pressed.	To release the hold-screen status, press the <i>Hold</i> key again.
	HOST BUSY	Appears when an XOFF condition occurs at the host system.	<p>Wait.</p> <p>The message disappears when the display station receives an XON character.</p>
	INVALID KEY	Appears when you press any invalid key.	Press any valid key.
	KEYBOARD ERROR	Appears when any key is pressed and a keyboard scan code error or keyboard overrun condition occurs.	Retry the operation.

Figure 4-2 (Part 4 of 10). Operator Messages

Operator Messages

Area	Message	Meaning	Action
3	KEYS LOCKED	Appears when the keyboard is locked by the Keyboard Lock command.	None. This status is cleared by the Keyboard Unlock command or when you press the <i>Cancel</i> key (in IBM 3151 and IBM 3101 mode) or when you perform Clear Status in the FUNCTION menu (in Ten ASCII terminals emulation mode).
	NUMERIC	The cursor is located in an unprotected numeric field.	None.
	PRINTING	Shows that data is being sent to the optional device on the auxiliary port.	None.
	PROBLEM IN KEYBOARD	Shows that a problem was detected in the keyboard.	<ol style="list-style-type: none"> 1. Set the power switch to 0 (Off). 2. Disconnect the keyboard cable; then reconnect it tightly. 3. Set the power switch to 1 (On). 4. Wait ten seconds. <p><i>Does "PROBLEM IN KEYBOARD" reappear?</i> Yes The keyboard is failing. Replace the keyboard. See page 5-20. No No problem exists; continue work.</p>

Figure 4-2 (Part 5 of 10). Operator Messages

Operator Messages

Area	Message	Meaning	Action
3	PROBLEM IN VIDEO ELEMENT OR KEYBOARD	Shows that a problem was detected in the video element or keyboard.	<ol style="list-style-type: none"> 1. Set the power switch to 0 (Off). 2. Wait ten seconds; then set the power switch to 1 (On). <p><i>Does "PROBLEM IN VIDEO ELEMENT OR KEYBOARD" reappear?</i></p> <p>Yes Go to step 3.</p> <p>No No problem exists; continue work.</p> 3. Set the power switch to 0 (Off). 4. Disconnect the keyboard cable. 5. Set the power switch to 1 (On); wait ten seconds. 6. Check the message on your screen. <p>If "PROBLEM IN VIDEO ELEMENT OR KEYBOARD" reappears, the video element is failing. Replace the video element. See page 5-20.</p> <p>If "PROBLEM IN KEYBOARD" appears, the keyboard is failing. Replace the keyboard. See page 5-20.</p>

Figure 4-2 (Part 6 of 10). Operator Messages

Operator Messages

Area	Message	Meaning	Action
3	RECEIVING	Shows that data is being received from the host system.	None.
	SENDING	Shows that data is being sent to the host system.	None.
	WRONG PLACE	Appears when you press any invalid key in a protected field or on a field attribute character position. It also appears when you try to insert a character or line where there is no space (Forcing Insert option is OFF).	None.
	WAIT	Appears when the keyboard buffer becomes full.	None. This message disappears when the keyboard-buffer-full condition is removed or when you perform Clear Status in the FUNCTION menu (the contents of the buffer are also cleared).

Figure 4-2 (Part 7 of 10). Operator Messages

Operator Messages

Area	Message	Meaning	Action
3	-->AUX	<p>Shows that the display station is operating in auxiliary print or transparent print mode.</p> <p>In transparent print mode, data sent from the host system is transferred to the optional device without appearing on the screen.</p> <p>In auxiliary print mode, data sent from the host system is transferred to the optional device and is displayed on the screen.</p>	To exit auxiliary print or transparent print mode, press the <i>Trace</i> key while holding down the <i>Ctrl</i> key.
	<-->AUX	<p>Shows that the display station is operating in bidirectional mode.</p> <p>In this mode, data sent from the host system or the optional device is transferred to the optional device or the host system, respectively, and only data from the host system is displayed on the screen.</p>	None.

Figure 4-2 (Part 8 of 10). Operator Messages

Operator Messages

Area	Message	Meaning	Action
4	INSERT	Shows that insert mode is selected when the <i>Insert</i> key is pressed or when the Insert Character command is received. <i>Note:</i> This message does not appear if MODE is not selected for the Insert Character in the KEYBOARD/PRINTER menu or in Ten ASCII terminals emulation mode.	To exit this mode, press the <i>Insert</i> or <i>Reset</i> key.
5	CAPS	Shows that caps-lock mode is selected when the <i>Caps Lock</i> key is pressed.	To exit this mode, press the <i>Caps Lock</i> key again.
	CONTROL	Appears when the <i>Ctrl</i> key is pressed and held down.	None.
	SUBSCRIPT	You can enter a subscript character.	None. To quit without entering a subscript character, press the <i>Reset</i> key.
	SUPERSCRIPT	You can enter a superscript character.	None. To quit without entering a superscript character, press the <i>Reset</i> key.
	UP SHIFT	Appears when the <i>Shift</i> key is pressed and held down.	None.

Figure 4-2 (Part 9 of 10). Operator Messages

Operator Messages

Area	Message	Meaning	Action
6	DRAW ¹	Shows that line-drawing mode is selected when the <i>Line Draw</i> key is pressed.	To exit this mode, press the <i>Line Draw</i> key again.
	NUM ²	Shows that numeric lock mode is selected when the <i>Num Lock</i> key is pressed.	To exit this mode, press the <i>Num Lock</i> key again.
7	TRACE ¹	Shows that trace mode is selected when the <i>Trace</i> key is pressed or when the <i>Trace On</i> command is received.	To exit this mode, press the <i>Trace</i> key again.
	PROTECT ³	Shows that the display station is operating in protect mode.	None.
8	(xxx,yyy)	<i>xxx</i> and <i>yyy</i> indicate the row and column addresses of the cursor, respectively.	None.

Figure 4-2 (Part 10 of 10). Operator Messages

-
- 1 This message does not appear in Ten ASCII terminals emulation mode.
 - 2 This message appears in IBM 3151 mode of IBM 3151 Model 11 only.
 - 3 This message does not appear in IBM 3151 and IBM 3101 modes.

Chapter 5. Solving Problems

This section helps you solve IBM 3151 problems, often without requiring any repair of the IBM 3151. When you have a problem, you need to determine whether the problem is in the IBM 3151, the modem or other communication equipment, or the application program in the host system.

Service Assistance: If you cannot complete the problem determination procedures, on-site assistance by an IBM service representative is available on a billable-hourly basis. The service representative will help you perform the problem determination and replace the failing element with a user-owned spare (if available).

The following figure shows a typical problem that is caused when cables are disconnected or the cartridge is not installed.

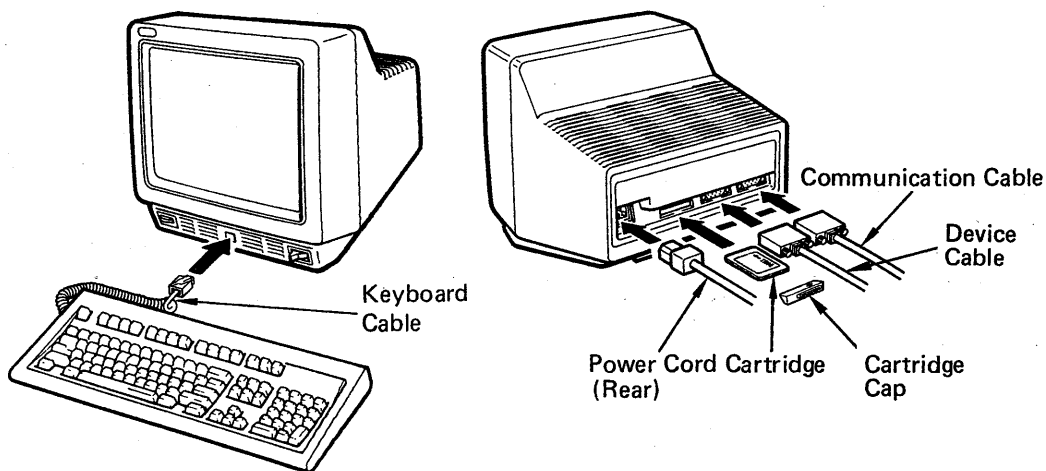

Figure 5-1. Example of Disconnected Cables and Cartridge

Solving Problems

Symptom List

Locate your error message or identify your symptom from the following list; then go to the page indicated.

Error Messages



PROBLEM IN KEYBOARD	4-7
PROBLEM IN VIDEO ELEMENT OR KEYBOARD	4-8
Unusual message or characters appear (such as a different language or characters with extra or missing dots)	5-4

Audible Alarm Problems

Alarm continues to sound	5-5
Alarm does not sound	5-7

Display Problems

Setup menu appears when powering on	5-8
Screen is blank	5-9
Reverse question marks (? . . .) appear some place on the screen	5-19
Screen appears to be rolling or moving	5-12
Screen is waving	5-13
Highlighted characters (reversed, underlined, or blinking characters) do not appear	5-12

(Continued on the next page)

Solving Problems

Characters that should appear brighter than others, do not.....	5-12
Characters have missing or additional dots (or are strange looking).....	5-12
Characters are replaced with other characters.....	5-12
Cursor does not appear or appears in the wrong place.....	5-12
Other screen problems (screen images do not appear normal).....	5-12

Keyboard Problems

No characters that you type appear.....	5-14
Typed characters are replaced with other characters.....	5-14
Extra characters appear when typing.....	5-14
Characters appear without typing.....	5-14
Some characters do not appear when typed.....	5-14
Cursor does not move when you type.....	5-14
Function key does not work.....	5-14
Repeat-action keys do not repeat.....	5-14

If you cannot find your symptom or you failed to isolate the problem, go to "Analysis Procedures" on page 5-15.

Solving Problems

Unusual Message or Characters Appear

1 If reverse question marks (¿ . . .) appear some place on the screen, go to page 5-19.

2 Look at the back side of the video element.

Is a cartridge inserted? (See Figure 5-1 on page 5-1 for location.)

Yes Go to step 3.

No If the cartridge is needed, set the power switch to O (Off); insert the cartridge, set the power switch to I (On), then continue work. (If the problem still exists, the video element is failing. Replace the video element.)

If the cartridge is not needed, the video element is failing. Replace the video element. See page 5-20 for instructions.

3 Set the power switch to O (Off).

4 Remove the cartridge.

5 Set the power switch to I (On); then wait ten seconds.

6 Press and hold the Ctrl and Shift keys, then press the Hold key.

7 Observe the screen.

Does the keyboard ID match the ID for your keyboard? (Refer to page 5-18 for IDs.)

Yes . The cartridge is failing. Order a new cartridge. See page 5-20.

No The keyboard is failing. Replace the keyboard. See page 5-20 for instructions.

Alarm Continues to Sound

- 1** Set the power switch to 0 (Off)
- 2** Wait ten seconds; then set the power switch to 1 (On).

Does the alarm continue to sound?

Yes Go to step 3.

No No problem exists.

- 3** Set the power switch to 0 (Off).
- 4** Disconnect the keyboard cable from the video element.
- 5** Set the power switch to 1 (On).

Does the alarm continue to sound?

Yes Go to step 6 on page 5-6.

No The keyboard is failing. Replace the keyboard. See page 5-20 for instructions.

Solving Problems

- 6** Look at the back side of the video element.

Is a cartridge inserted? (See Figure 5-1 on page 5-1 for location.)

Yes Set the power switch to O (Off); remove the cartridge; insert the keyboard cable into the video element, then set the power switch to I (On). If the alarm still continues to sound, replace the video element; If not, the cartridge is failing. Order a new cartridge. See page 5-20 for instructions.

No The video element is failing. Replace the video element. See page 5-20 for instructions.

Alarm Does Not Sound

If the screen is blank, go to page 5-9.

- 1** Set the power switch to O (Off); wait ten seconds, then set the power switch to I (On).

Does the alarm sound once?

Yes Go to step 2.

No Go to step 3.

- 2** Press and hold the Ctrl key, then press the +Alrm key.

Does the alarm sound once?

Yes Adjust the sound of audible alarm for your comfort; then continue work.

No The keyboard is failing. Replace the keyboard. See page 5-20 for instructions.

- 3** Look at the back side of the video element.

Is a cartridge inserted? (See Figure 5-1 on page 5-1 for location.)

Yes Set the power switch to O (Off); remove the cartridge, then set the power switch to I (On).

If the alarm sounds once, the cartridge is failing; order a new cartridge. If not, the video element is failing. Replace the video element. See page 5-20 for instructions.

No The video element is failing. Replace the video element. See page 5-20 for instructions.

Solving Problems

Setup Menu Appears

Note: If the video element is new and the setup-value Save operation has not been performed, this menu normally appears on the screen.

- 1** *Is your IBM 3151 new or has the video element been replaced?*
 - Yes** Go to step 6.
 - No** Go to step 2.

- 2** Select the FUNCTION menu by pressing the *Send* key three times.

- 3** Select the Save field using the *Cursor Move* keys (↑ ↓ ← →), then press the *Space Bar*.

- 4** Set the power switch to O (Off); wait ten seconds.

- 5** Set the power switch to I (On).

Does the setup menu reappear on the screen?

- Yes** The video element is failing. Replace the video element. See page 5-20 for instructions.

- No** Go to step 6.

- 6** Perform the setup-value definitions. See "Defining Setup Values" on page 2-14 for details. If you use an emulation cartridge, see the emulation guide shipped with the cartridge.

Note: Remember to select the Save field and press the space bar to complete the setup operation. Otherwise the setup menu will reappear the next time power is turned on.

Screen is Blank

Note: If the audible alarm continues to sound, go to “Alarm Continues to Sound” on page 5-5.

- 1** Turn the brightness control knob fully counterclockwise.
- 2** Press any key.

Is the screen still blank?

Yes Go to step 3.

No This is normal operation. The message area was inactive. No problem exists; continue work.

- 3** Set the power switch to O (Off).
- 4** Check the power source.

Do you have power at the power outlet?

Yes Go to step 5.

No Report this problem to your supervisor.

- 5** Set the power switch to I (On).

Is the screen still blank?

Yes Go to step 6 on page 5-10.

No No problem exist; continue work.

Solving Problems

- 6** Press and hold the Ctrl and Shift keys, then press the Hold key.

Does the test pattern appear on the screen as shown on page 5-17?

Yes Report this problem to your supervisor.

No Go to step 7.

- 7** Set the power switch to O (Off).

- 8** Disconnect the keyboard cable.

- 9** Set the power switch to I (On); wait ten seconds.

Does "PROBLEM IN KEYBOARD" appear?

Yes The keyboard is failing. Replace the keyboard. See page 5-20 for instructions.

No Go to step 10.

- 10** Look at the back side of the video element.

Is a cartridge inserted? (See Figure 5-1 on page 5-1 for location.)

Yes Set the power switch to O (Off); remove the cartridge; insert the keyboard cable into the video element, then go to step 11 on page 5-11.

No Set the power switch to O (Off); insert keyboard cable into the video element, then go to step 13 on page 5-11.

11 Set the power switch to I (On).

Is the screen still blank?

Yes Go to step 12.

No The cartridge is failing. Order a new cartridge. See page 5-20 for instructions.

12 Set the power switch to O (Off).

13 Exchange the power cord.

14 Set the power switch to I (On).

Is the screen still blank?

Yes The video element is failing. Replace the video element. See page 5-20 for instructions.

No The power cord is defective. Order a new power cord. See page 5-20.

Solving Problems

Other Display Problems

- Screen appears to be rolling or moving
- Highlighted characters (reversed, underlined, or blinking characters) do not appear
- Characters that should appear brighter than others, do not
- Characters have missing or additional dots (or are strange looking)
- Characters are replaced with other characters
- Cursor does not appear or appears in the wrong place
- Screen images do not appear normal.

If the problem occurs when keys are typed, go to page 5-14.

1 Set the power switch to O (Off); wait ten seconds.

2 Set the power switch to I (On).

Does the alarm sound once?

Yes Go to step 3.

No The video element is failing. Replace the video element. See page 5-20 for instructions.

3 Press and hold the Ctrl and Shift keys, then press the Hold key.

4 Compare all characters of the test pattern shown on page 5-17 with your screen.

Do all characters match?

Yes Report this problem to your supervisor.

No The video element is failing. Replace the video element. See page 5-20 for instructions.

Screen is Waving

Note: This symptom may occur if you have another display station, fluorescent light, motor, or other electrical device near your display station.

1. Check the area near your display station.

Is there another display station, fluorescent light, motor, or other electrical device near your display station?

Yes Go to step 2.

No The video element is failing. Replace the video element. See page 5-20 for instructions.

2. Set off the power of the other electrical device or move it away from your display station.

Does the problem still exist?

Yes The video element is failing. Replace the video element. See page 5-20 for instructions.

No Report this problem to your supervisor.

Solving Problems

Keyboard Problems

If the screen is blank, go to page 5-9.

1 Set the power switch to O (Off); wait ten seconds.

2 Set the power switch to I (On).

Does the alarm sound once?

Yes Go to step 3.

No The keyboard is failing. Replace the keyboard. See page 5-20 for instructions.

3 Press and hold the Ctrl and Shift keys, then press the Hold key.

4 Observe the bottom left of the screen.

Does "TEST" appear at the bottom left of the screen?

Yes Go to step 5.

No The keyboard is failing. Replace the keyboard. See page 5-20 for instructions.

5 While observing the screen, repeatedly press the key that did not work.

Does only one corresponding position in the screen change from □ to ■ or vice versa?

Yes Report this problem to your supervisor.

No The keyboard is failing. Replace the keyboard. See page 5-20 for instructions.

Analysis Procedures

Perform the following procedures when you cannot match a display station symptom with any of the ones in the symptom charts or you failed to isolate the problem.

1. Set the power switch to O (Off).
2. Make sure that all required cables are connected tightly.

DANGER

Do not handle the communication cable during an electrical storm. Communication cables can conduct lethal charges of electricity.

If "PROBLEM IN KEYBOARD" appears on the screen, go to page 4-7. If "PROBLEM IN VIDEO ELEMENT OR KEYBOARD" appears on the screen, go to page 4-8.

If the screen is blank, go to page 5-9.

3. Set the power switch to I (On).
Does the alarm sound once?
Yes Go to step 4.
No If the alarm continues to sound, go to "Alarm Continues to Sound" on page 5-5; if the alarm does not sound, go to "Alarm Does Not Sound" on page 5-7.
4. Observe the screen.
Does the setup menu appear on the screen?
Yes Go to "Setup Menu Appears" on page 5-8.
No Go to step 5 on page 5-16.

Analysis Procedures

5. Press and hold the Ctrl and Shift keys, then press the Hold key.
Does the test pattern appear on the screen as shown on page 5-17?
Yes Go to step 6.
No The keyboard is failing. Replace the keyboard. See page 5-20.

6. Compare all characters of the test pattern shown on page 5-17 with your screen.
Do all characters match?
Yes Go to step 7.
No The video element is failing. Replace the video element. See page 5-20.

7. Observe the keyboard ID on the screen (see page 5-17).
Does the keyboard ID match the ID for your keyboard?
Yes Go to step 8.
No The keyboard is failing. Replace the keyboard. See page 5-20.

8. While observing the screen, repeatedly press any key or the key that did not work.
Does only one corresponding position in the screen change from □ to ■ or vice versa?
Yes Go to “Communication Problems” on page 5-19.
No The keyboard is failing. Replace the keyboard. See page 5-20.

Test Pattern

The test pattern is used to help identify video element and keyboard problems. When you press and hold the Ctrl and Shift keys, then press the Hold key, the test pattern appears.

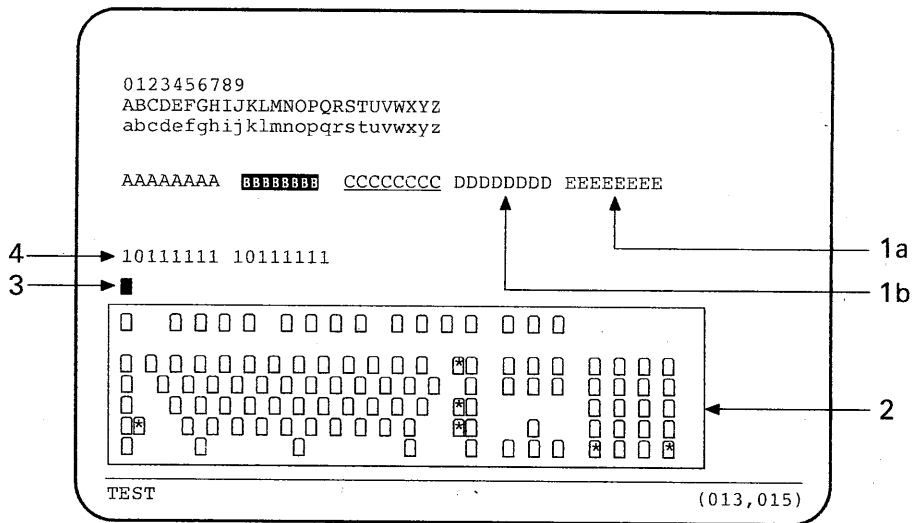

1. High-intensity check pattern

1a: These characters are brighter than others.

1b: These characters blink.

2. Key-to-display test pattern

This pattern represents the keyboard keys. Boxes marked by asterisks (*) are not changed and are dependent on the keyboard type.

Note: If you are using the Model 11, the test pattern that represents the numeric keypad is not displayed.

3. Cursor function test pattern

The cursor is block style.

Using the Test Pattern

4. Keyboard ID check pattern

The keyboard ID is dependent on the following keyboard types.

Keyboard Type	Keyboard ID
U.S. English (with numeric keypad)	10111111 10111111
U.S. English (without numeric keypad)	10000001 10000000

Figure 5-2. IBM 3151 Keyboard IDs

Communication Problems

When the IBM 3151 has a communication problem with the host system:

- Reverse question marks (? . . .) appear some place on the screen
or
- COMM NOT READY 1 or COMM NOT READY 2 appears on the bottom of the screen
or
- Strange characters appear, characters are replaced with other characters, or no characters are displayed.

The communication problem occurs with one of the following conditions. If you know the check method, check each condition in the following sequence. If you do not know the check method, report the problem to your supervisor.

1. A setup value, such as line speed, parity, or stop bit, does not match the host system's value.

Check the setup-value definitions on the COMMUNICATION menu.

- A parity error occurred in the received data.
 - A stop bit was dropped in the received data.
 - An overrun condition occurred in the display station when receiving data.
 - A break signal was detected.
2. Application program problem.
 3. Modem or ROLM¹ data communications equipment problem.
 4. Modem cable problem.

¹ Registered trademark of ROLM Corporation

If Service is Required

If Service is Required

When your display station requires service, perform the following steps.

1. Set the power switch to O (Off); disconnect all cables from the video element.
2. Be prepared to give the following: (this information will be used in step 3.)
 - Your machine type
 - The serial number and part number of the failing element
 - Symptom
 - Your telephone number, address, and zip code.

Note: If the cartridge or power cord is defective, use the serial number of the video element.

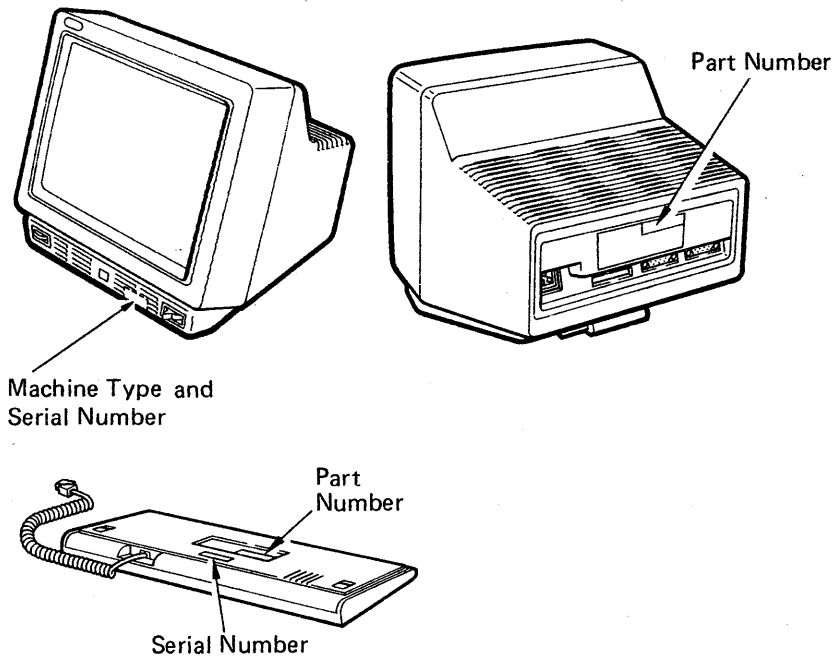

If Service is Required

3. Call the IBM Service/Exchange Communications Center.

For the United States and Puerto Rico, dial the toll-free number 1-800-428-2569.

Note: Customers in countries other than the U.S. should contact the local IBM Customer Service Dispatch or the place of purchase.

The IBM Service/Exchange Communications Center will verify your warranty and maintenance agreement status, and will tell you what to do with your failing element.

4. If you need to return an element, see Chapter 2, "Setup Procedures" on page 2-1, then remove the element in the reverse sequence (from step 5 through step 1).
5. If service is needed on your video element, remove the cartridge (if any), stand (if any), and power cord (if you are a customer in Chicago, Illinois or a customer in other than the U.S. and Canada) before service is performed on the video element. If the special key caps for emulation mode are installed, remove and keep them. Then install the standard key caps (see Figure 3-1 on page 3-1 for the standard keyboard layout).

(Continued on the next page)

If Service is Required

6. When you need to remove the stand (optional), do the following.

While pushing the latch to the left **1**, slide the stand in the direction of the arrow **2**, then lift and remove the stand.

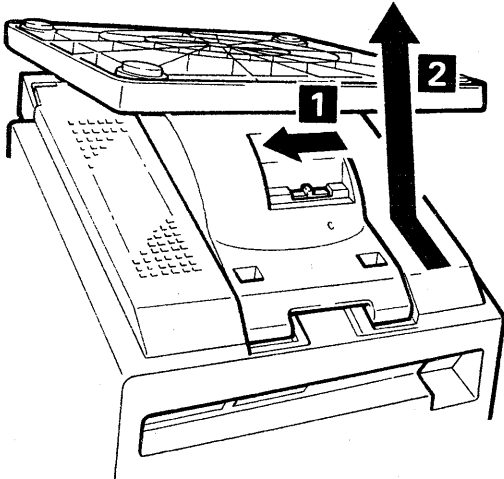

7. When you replace an element, see Chapter 2, "Setup Procedures" on page 2-1.

Note: When installing a new video element, you must define the setup values.

Appendix A. Emulating the IBM 3101 Display Terminal

This appendix describes the IBM 3101 functions that are *different* or *not* supported when operating in emulation mode. It also describes the *additional* functions. Other IBM 3101 functions work as they normally do in the IBM 3101.

This appendix is for those who want to use an IBM 3151 Model 31 or 41 as an IBM 3101 and who already have a basic understanding of the IBM 3101. You may require *IBM 3101 Display Terminal Description*, GA18-2033 for reference.

The IBM 3151 Models 31 and 41 can emulate the IBM 3101 by selecting IBM 3101 for the Machine Mode in the GENERAL menu. See "Defining Setup Values" on page 2-14 for instructions. You can also select IBM 3101 mode by the "Set Control 1" command. See *IBM 3151 ASCII Display Station Reference Manual* for more information. You can run the same application programs that were used for running the IBM 3101.

IBM 3101 Emulation

Functions Supported Differently in Emulation Mode

The following figure shows which emulated IBM 3101 functions are different from the original IBM 3101 and how they are different.

Original IBM 3101	IBM 3101 Emulation Mode
Setup Switches	Replaced with the setup menus. You can define the Pacing option in addition to all IBM 3151 setup values. See "Setup Menus and Setup Value Descriptions" on page 2-17 for more information.
Keyboard Layout	Figure A-2 on page A-3 shows an IBM 3101 emulation keyboard.
Key Labels	Some labels on the keys are printed differently. See Figure A-3 on page A-4.
Operator Messages	Some messages are displayed with different words. See Figure A-4 on page A-5.
Displayed Characters	Shapes of the following characters are different: <ul style="list-style-type: none">• DC1• DC2• DC3• DC4• Send mark (⌘). A SUB character is converted to a reverse question mark (?).

Figure A-1. Functions Supported Differently in Emulation Mode

IBM 3101 Emulation

Note: Some labels of the keys are printed differently on the actual keyboard.

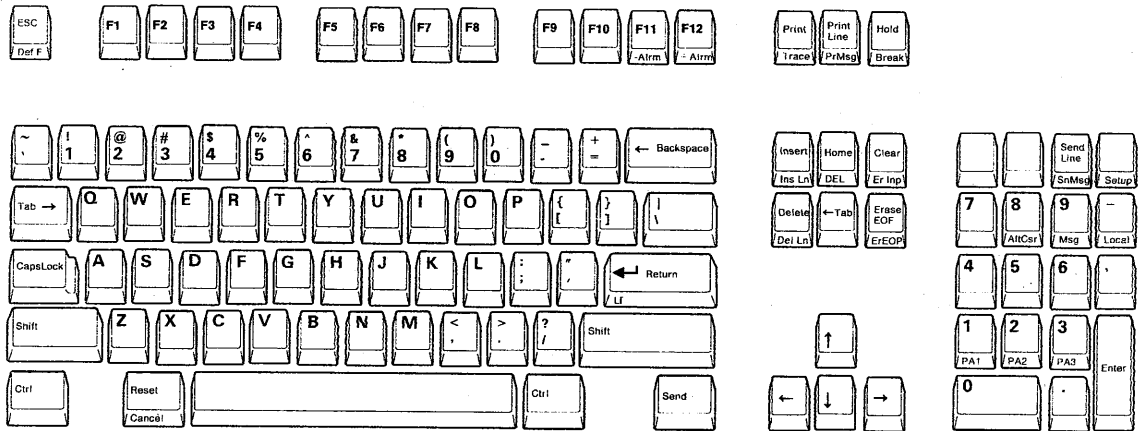

Figure A-2. IBM 3101 Emulation Keyboard

IBM 3101 Emulation

Key Labels

The following figure shows the IBM 3101 keys and their equivalent keys in emulation mode.





IBM 3101 Keys	Equivalent Keys in Emulation Mode
ALT	Ctrl
DEL CHAR	Delete
DEL LINE	Del Ln
ERASE EOL/EOF	Erase EOF
ERASE EOS	ErEOP
ERASE INPUT	Er Inp
INS CHAR	Insert
INS LINE	Ins Ln
PF1 - PF8	F1 - F8
PRINT MSG	Pr Msg
SEND MSG	Sn Msg
	Caps Lock
	Shift
	 Return

Figure A-3. Equivalent Keys

IBM 3101 Emulation

Operator Messages

The following figure shows the IBM 3101 operator messages and their equivalent messages in emulation mode.

IBM 3101 Operator Messages	Operator Messages in Emulation Mode
CHAR MODE	CHAR or ECHO
BLOCK MODE	BLOCK
(XPARENT)	TRANSP
(PROGRAM)	Not applicable
(IN ATTR)	Not applicable
LINE CHECK 1	COMM NOT READY 1
LINE CHECK 2	COMM NOT READY 2
SYSTEM NOT READY	HOST BUSY
RE-KEY	KEYBOARD ERROR
SYSTEM COMMAND	KEYS LOCKED
PRINTING	PRINTING
SENDING	SENDING
DISABLED KEY	INVALID KEY
MODE/SETUP CHECK	INVALID KEY
FORMAT CHECK	WRONG PLACE
INSERT	INSERT
UP SHIFT	UP SHIFT
S	SENDING
R	RECEIVING
LOCAL	LOCAL
AUX ON	TRACE

Figure A-4. Equivalent Operator Messages

Functions Not Supported in Emulation Mode

The following functions are not supported in emulation mode:

- Keyboard functions
 - ATTR
 - AUX
 - PRGM MODE
 - 
- Hardware trace.

Additional Functions in Emulation Mode

The IBM 3151 Models 31 and 41 provides the following additional functions:

- Large-screen support (25 lines of 132 characters)

You can select a screen format from a setup menu or by the “Create Viewport” command.

- Smooth scrolling
- Pacing
- Keyboard functions.

Additional Keyboard Functions

You can use the following additional keyboard functions in emulation mode. See Chapter 3, “Understanding the Keyboard Functions” on page 3-1 for the function of each key. When you use the IBM 3151 Models 31 and 41 functions, which are not listed here but shown on the actual keyboard, the audible alarm will sound.

- + Alrm
- – Alrm
- Alt Csr
- Def F
- Enter
- F9 - F36
- Hold
- Msg (turns the OIA indication on or off)
- PA1 - PA3
- Setup
- Trace.

IBM 3101 Emulation

Emulating the Ten ASCII Terminals

Appendix B. Emulating the Ten ASCII Terminals

The IBM 3151 can emulate any one of ten ASCII terminals. Selecting the emulation mode is done from a setup menu or host command.

The ASCII terminals that can be emulated are:

- ADM-3A
- ADM-5
- ADDS Viewpoint-A2
- Hazeltine 1500
- TeleVideo Model 910
- TeleVideo Model 910+
- TeleVideo Model 912
- TeleVideo Model 920
- TeleVideo Model 925
- TeleVideo Model 925E.

In most instances, you can run the same application programs that were running the terminal when using the IBM 3151 in emulation mode.

This chapter describes the different, the additional, and the unsupported functions when operating in emulation mode.

Emulating the Ten ASCII Terminals

Functions Supported Differently in Emulation Mode

The following figure shows which emulated terminal functions are different and how they are different.

Function	Difference in Emulation Mode
Test commands	Replaced with the internal check program. This program runs automatically each time the display station is powered-on or test mode is started.
Keyboard layout	A keyboard overlay (GX18-2288) is provided to permit use of the IBM 3151 keyboard for Ten ASCII Terminals emulation. Both sides of the overlay are used to support two types of keyboards. See Figure B-2 on page B-3 for overlay placement. Key caps are provided optionally. Figure B-3 shows the emulation keyboards after key caps have been changed.
Keyboard labels	Some labels on the keys are printed differently. See "Key Labels" on page B-7.
Main port	The IBM 3151 uses an EIA RS-232C DTE-type female connector.
Auxiliary port	The IBM 3151 uses an EIA RS-232C DCE-type female connector.
Displayed characters	Shapes and sizes are different.
Setup menus	Menu layouts and definitions are different. See "Setup Menus and Setup Value Descriptions" on page 2-17 for more information.

Figure B-1. Functions Supported Differently in Emulation Mode

Emulating the Ten ASCII Terminals

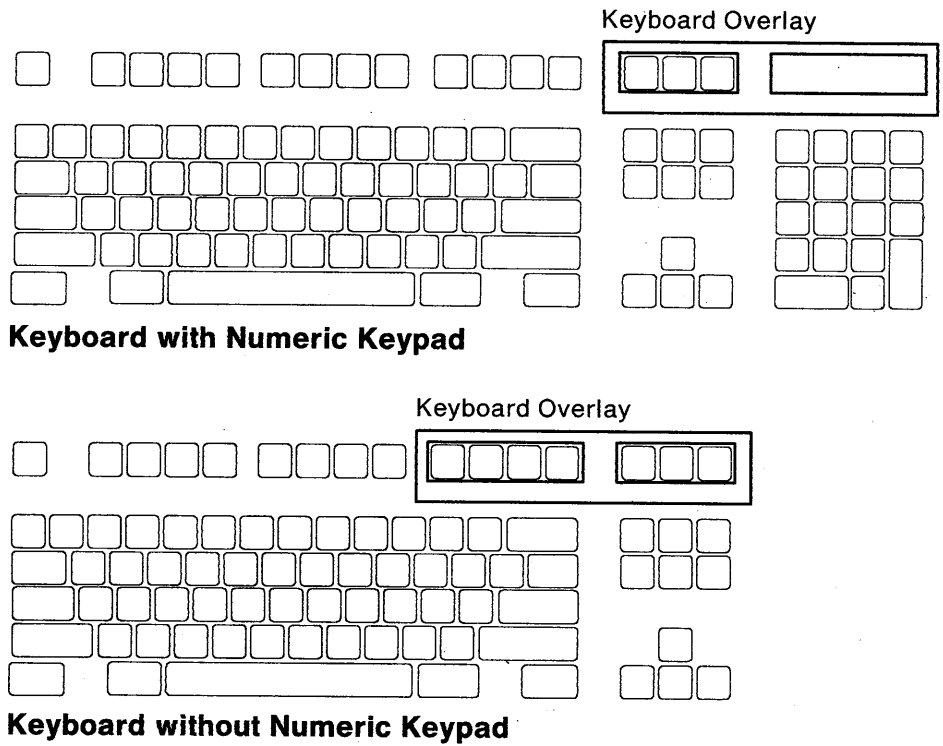

Figure B-2. Keyboard Overlay Locations

Emulating the Ten ASCII Terminals

Emulation Keyboard

If you have key caps for the ten ASCII terminals (optional), change the key caps according to the following procedures.

a

Using the key-cap-removal tool, remove the key caps shown below (non-shaded).

Keep the key caps that you remove for possible later use. Key caps that you change here must be returned to their original positions before returning the keyboard to IBM.

Removal tool

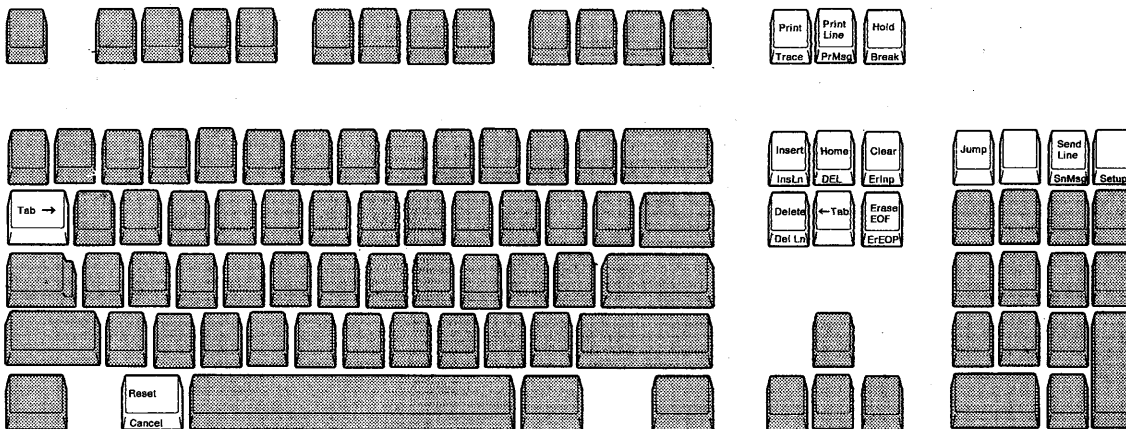
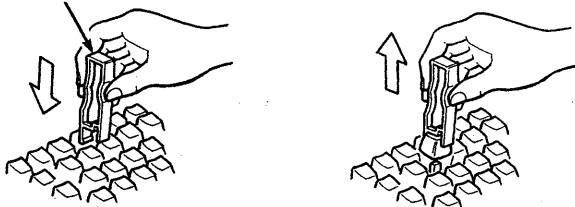

Emulating the Ten ASCII Terminals

b Install the 15 key caps in the positions shown on the keyboard below.

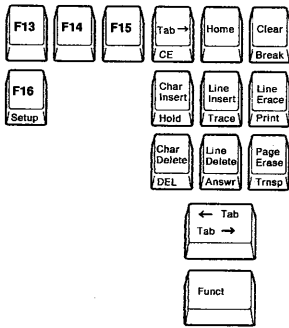

15 Key Caps

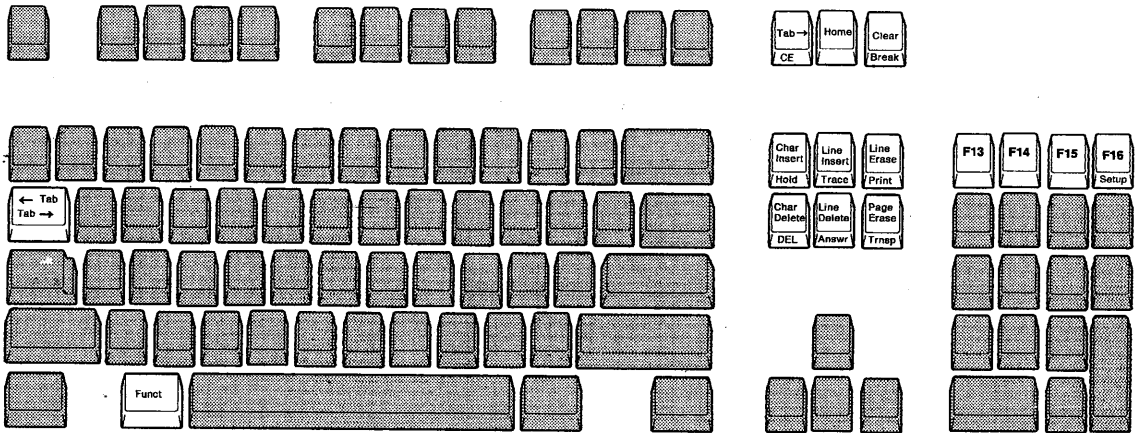

Emulating the Ten ASCII Terminals

C After making the changes, your keyboard should look like this.

Figure B-3 shows the emulation keyboard.

Notes:

1. Some labels of the keys are printed differently on the actual keyboard.
2. The function printed on the front of each key is performed when the key is pressed with the **Ctrl** key.

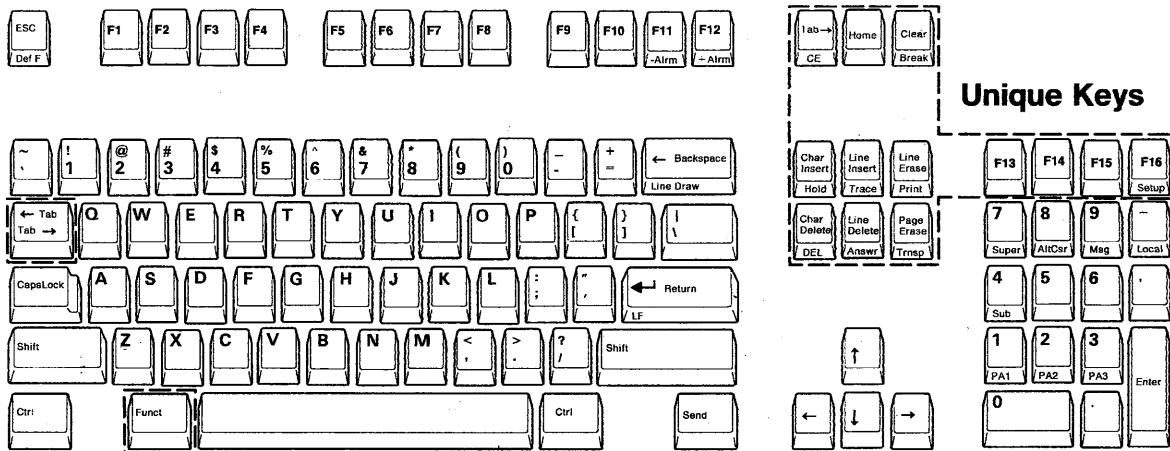

Figure B-3. Emulation Keyboard

Emulating the Ten ASCII Terminals

Key Labels

This section describes the key labels between the original keyboards and the emulated keyboards.

ADM-3A

The following figure shows the ADM-3A keys and their equivalent keys in emulation mode.

Note: "Not supported" means neither the key nor the function exists.

ADM-3A Keys	Equivalent Keys in Emulation Mode
HERE IS	Answr
LINE FEED	LF
RUB	DEL
REPEAT	Not supported

Figure B-4. ADM-3A Equivalent Keys

ADM-5

The following figure shows the ADM-5 keys and their equivalent keys in emulation mode.

ADM-5 Keys	Equivalent Keys in Emulation Mode
ERASE LINE	Line Erase
ERASE PAGE	Page Erase
HERE IS	Answr
LINE FEED	LF

Figure B-5 (Part 1 of 2). ADM-5 Equivalent Keys

Emulating the Ten ASCII Terminals

ADM-5 Keys	Equivalent Keys in Emulation Mode
PROG	Trnsp
RUB	DEL
TAB	Tab →

Figure B-5 (Part 2 of 2). ADM-5 Equivalent Keys

ADDS Viewpoint-A2

The following figure shows the ADDS Viewpoint-A2 keys and their equivalent keys in emulation mode.

ADDS Viewpoint-A2 Keys	Equivalent Keys in Emulation Mode
LOCK	Caps Lock
TAB	Tab →

Figure B-6. ADDS Viewpoint-A2 Equivalent Keys

Hazeltine 1500

The following figure shows the Hazeltine 1500 keys and their equivalent keys in emulation mode.

Note: "Not supported" means neither the key nor the function exists.

Hazeltine 1500 Keys	Equivalent Keys in Emulation Mode
ALL CAPS	Caps Lock
BACKSPACE	← Backspace or ←

Figure B-7 (Part 1 of 2). Hazeltine 1500 Equivalent Keys

Emulating the Ten ASCII Terminals

Hazeltine 1500 Keys	Equivalent Keys in Emulation Mode
BACKSPACE with SHIFT	→
CLEAR with CTRL	Line Erase
CLEAR with CTRL + SHIFT	Page Erase
LINE FEED	LF
RESET	Not supported
TAB	Tab →

Figure B-7 (Part 2 of 2). Hazeltine 1500 Equivalent Keys

TeleVideo Models 925/925E

The following figure shows the TeleVideo Models 925/925E keys and their equivalent keys in emulation mode.

Note: “Not supported” means neither the key nor the function exists.

TeleVideo Models 925/925E Keys	Equivalent Keys in Emulation Mode
ALPHA LOCK	Caps Lock
BREAK with CTRL	Break
BREAK with CTRL + SHIFT	Clear Status in the FUNCTION menu
CLEAR SPACE	Screen Clear
CLEAR SPACE with Shift	Clear
LINE ERASE	Line Clear
LOC ESC	ESC with Shift
LINE FEED	LF
NO SCROLL	Hold

Figure B-8 (Part 1 of 2). TeleVideo Models 925/925E Equivalent Keys

Emulating the Ten ASCII Terminals

TeleVideo Models 925/925E Keys	Equivalent Keys in Emulation Mode
PAGE	Not supported
PAGE ERASE	Screen Clear
RESET	Not supported
RESET with CTRL	Reset Terminal in the FUNCTION menu
RESET with SHIFT	Not supported

Figure B-8 (Part 2 of 2). TeleVideo Models 925/925E Equivalent Keys

TeleVideo Models 912/920

The following figure shows the TeleVideo Models 912/920 keys and their equivalent keys in emulation mode.

Note: "Not supported" means neither the key nor the function exists.

TeleVideo Models 912/920 Keys	Equivalent Keys in Emulation Mode
ALPHA LOCK	Caps Lock
BACK TAB	← Tab
BLOCK-CONV with CTRL	Operating Mode in the GENERAL menu
BLOCK-CONV with SHIFT	Operating Mode in the GENERAL menu
CLEAR SPACE	Clear
LINE FEED	LF
NEW LINE	Not supported
PAGE	Not supported

Figure B-9 (Part 1 of 2). TeleVideo Models 912/920 Equivalent Keys

Emulating the Ten ASCII Terminals

TeleVideo Models 912/920 Keys	Equivalent Keys in Emulation Mode
PROT MODE	Not supported
PROT MODE with Shift	Operating Mode in the GENERAL menu
RUBOUT	DEL
SEND with SHIFT	No function
SEND LINE	Send with Shift
SEND LINE with SHIFT	Not supported
TAB	Tab →
TAB SET	Not supported

Figure B-9 (Part 2 of 2). TeleVideo Models 912/920 Equivalent Keys

TeleVideo Models 910/910 +

The following figure shows the TeleVideo Models 910/910+ keys and their equivalent keys in emulation mode.

TeleVideo Models 910/910 + Keys	Equivalent Keys in Emulation Mode
ALPHA LOCK	Caps Lock
BACK TAB	← Tab (or Tab with Shift)
CLEAR SPACE	Clear
LINE FEED	LF
PRINT	Trace
TAB	Tab →

Figure B-10. TeleVideo Models 910/910+ Equivalent Keys

Emulating the Ten ASCII Terminals

Functions Not Supported in Emulation Mode

The following functions are not supported in their respective emulation modes:

ADM 3A mode

- 12 Lines/Page option
- Selection of the Cursor Control option (always set to ON)
- Selection of the Cursor Space option (always set to OFF)
- Selection of the Disable Clear Screen option (always set to OFF)
- Unique ADM-3A half-duplex operation
- Repeat key.

ADM 5 Mode

Unique ADM-5 half-duplex operation.

ADDS VP A2 Mode

- Keyclick
- Selection of the character set (always set to the U.S. English character set)
- Selection of the break-signal length (always set to 250 ms).

Emulating the Ten ASCII Terminals

HZ1500 Mode

20 mA current loop communication interface.

TVI925E/925 Mode

- Keyclick
- Selection of the character generated by the Cursor Down (↓) key (the ASCII SYN character is always generated)
- The Set Time of Day and Page Print with Time of Day commands
- The Page Print with Time of Day key
- Alternate pages (only one page can be used)
- Auto flip on and auto flip off
- Pacing by the DTR (data terminal ready) signal
- "Run the Self Test" command is replaced with the internal check program mode.

TVI920/912 Mode

- Selection of handling the DSR (data set ready), CD (carrier detect), and DTR signals

The IBM 3151 handles these signals as follows:

- When PRTS is selected for line control:

The IBM 3151 checks the DSR and CTS (clear to send) signals. It raises the DTR and RTS (request to send) signals when data transmission is possible.

Emulating the Ten ASCII Terminals

- When IPRTS (induced permanent request to send) is selected for line control:

The IBM 3151 does not check the DSR, CD, and CTS signals. It raises the DTR and RTS signals when data transmission is possible.

- When CRTS (controlled request to send) is selected for line control:

The IBM 3151 checks the DSR and CTS signals. It raises the DTR signal when data transmission is possible and raises the RTS signal when data is transmitted.

- Selection of the default print mode (print mode is always set to page-print mode when power is turned on)
- Field-attribute characters are handled as protected characters in protect mode
- Alternate pages (only one page can be used)
- The Auto Flip On and Auto Flip Off commands.

TVI910 + /910 Mode

- Selection of handling the DSR, CD, and DTR signals
- Pacing by the DTR signal
- Selection of type of the cursor down key (always set to 950/925 mode)
- “Run the Self Test” command is replaced with the internal check program mode.

Emulating the Ten ASCII Terminals

Additional Functions in Emulation Mode

The IBM 3151 provides the following additional functions:

- Adjustable audible alarm
- 25 lines of 80 characters and 25 lines of 132 characters screen support (IBM 3151 Models 31 and 41 only)
- Two speed smooth scrolling (IBM 3151 Models 31 and 41 only)
- CRT saver on/off
- Operator information area

The operator information area (OIA) is the bottom line of the screen where indicators and messages show the status of the display station.

- Enhanced commands

See Chapter 4, "Interpreting Operator Messages" on page 4-1 for more information.

- Keyboard functions (described in more detail in *IBM 3151 ASCII Display Station Reference Manual*).

Emulating the Ten ASCII Terminals

Glossary

This glossary defines terms and abbreviations that are used in this guide. It also includes terms and definitions from *IBM Vocabulary for Data Processing, Telecommunications, and Office Systems*, GC20-1699, as well as developed by the American National Standards Institute (ANSI) and the International Organization for Standardization (ISO). This material is reproduced in part from the *American National Dictionary for Information Processing*, Copyright 1977, by the Computer and Business Equipment Manufacturers Association, copies of which may be purchased from the American National Standards Institute, 1430 Broadway, New York, NY 10018. Definitions from published sections of *ISO Vocabulary of Data Processing* are identified by the symbol "(ISO)" preceding the definition.

The symbols "(TC95)" and "(TC97)" at the beginning of a definition indicate that the definition is reproduced from a working document or draft proposal of ISO Technical Committee 95 (Office Machines) or ISO Technical Committee 97, Subcommittee 1 (Data Processing) and the final agreement has not yet been reached among its participating members.

ANSI definitions are preceded by an asterisk. An asterisk placed to the left of the term indicates that the entire definition is taken from the *American National Dictionary for Information Processing*; where definitions from other sources are included in the entry, ANSI definitions are identified by an asterisk to the right of the item number.

A

active page. The page in which the cursor is located.

active partition. The partition in which the cursor is located.

application program. A program written for or by a user that applies to the user's work.

* **ASCII.** American National Standard Code for Information Interchange. The standard code, using a coded character set consisting of 7-bit coded characters (8 bits including parity check), used for information interchange among data processing systems, data communication systems, and associated equipment. The ASCII set consists of control characters and graphic characters.

ASCII control characters. Deprecated term for American National Standard control characters.

attribute. See display attribute.

audible alarm. An alarm that is activated when predetermined events occur that require operator attention or intervention for system operation.

auxiliary port. A port that is used to communicate with the optional device (such as a printer).

Glossary

B

binary digit. (1) * (ISO) In binary notation, either of the characters 0 or 1. (2) Synonymous with bit.

bit. Synonym for binary digit.

block mode. A method of transmitting data in groups of bits or characters as a unit (block). See also character mode and echo mode.

bps. Bits per second. In serial transmission, the instantaneous bit speed with which a device or channel transmits a character.

buffer. (1) * A routine or storage used to compensate for a difference in the rate of flow of data, or time of occurrence of events, when transferring data from one device to another. (2) A portion of storage for temporarily holding input or output data.

byte. (1) * A binary character operated upon as a unit and usually shorter than a computer word. (2) The representation of a character.

C

cartridge. An element that stores the program to operate the IBM 3151 in emulation mode.

CD. Carrier detect.

character. A language unit composed of bits, for example, a letter, number, or special symbol, such as an asterisk or question mark.

character mode. A method of transmitting data one character at a time, rather than by blocks and at the same time displaying it on the screen. See also block mode and echo mode.

COMMUNICATION menu. One of the setup menus that is used to define the IBM 3151 setup parameters concerning the communications with the host system.

contention. (1) (TC97) A condition arising when two or more data stations attempt to transmit at the same time over a shared channel, or when two data stations attempt to transmit at the same time in two-way alternate communication. (2) A line-control scheme in which stations on a line compete for the use of that unused line; the station that is successful in gaining control of the line is able to transmit.

CR. Carriage return.

CRT. Cathode ray tube.

CRTS. Controlled request to send.

CTS. Clear to send.

current field. A field in which the cursor is located.

current line. A line on which the cursor is located.

cursor. (1) (TC97) In computer graphics, a movable marker that is used to indicate a position on a display surface. (2) (TC95) A displayed symbol that acts as a marker to help the user locate a point in text, in a system command, or in storage. (3) A movable spot of light on the screen of the display device, usually indicating where the

Glossary

next character will be entered, replaced, or deleted.

D

data. Information that is digital in form when processed by a computer.

data stream. All data transmitted through a communication line in a single operation.

default. An alternative value, attribute, or option that is assumed when none has been specified.

display attribute. (TC97) In computer graphics, a particular property that is assigned to all or part of a display; for example, low intensity, green color, blinking status.

DSR. Data set ready.

DTR. Data terminal ready.

E

echo mode. A method of transmitting data one character at a time, rather than by blocks. The host system then returns the data for display on the screen. See also block mode and character mode.

ESC (escape) sequence. A character string that begins with the ESC character. See also host command.

EIA. Electronic Industry Association

EIA RS-232C. An Electronic Industry Association (EIA) communications interface standard.

emulation. (1) (TC97) The imitation of all or part of one computer system by another, primarily by hardware, so that the imitating computer system accepts the same data, executes the same programs, and achieves the same results as the imitated computer system. (2) The use of programming techniques and special machine features to permit a computing system to execute programs written for another system.

EOT. End of transmission.

ETX. End of text.

F

field. An area that consists of a field attribute and the data following it. See also field attribute.

field attribute. A control character stored in the character buffer in the first character position of a field. A field attribute defines the characteristics (such as high-intensity and blinking) of the field.

field tab. A function that advances the cursor to the first character position of the next unprotected field, if it exists.

formatted page. A page in which one or more fields have been defined by an application program. Contrast with unformatted page.

full duplex. A method of transmission in which both stations can receive and transmit simultaneously.

Glossary

function key. See program function key.

FUNCTION menu. One of the setup menus that is used, for example, to save the definitions that are made on the other menus.

G

GENERAL menu. One of the setup menus that is used to define the IBM 3151 setup parameters (such as machine mode and terminal ID).

H

half duplex. A method of transmission in which signals can go in both directions, but in only one direction at any given time.

home position. A first unprotected character position in a screen or partition.

host command. A character string that is sent from the host system or entered from the keyboard to control the terminal's functions.

host system. (1) A data processing system that is used to prepare programs and the operating environments for use on another computer or controller. (2) The data processing system to which a network is connected and with which the system can communicate.

host message. A message defined by an application program and displayed in the bottom of the screen using the message (Msg) key.

I

IBM marketing representative. The person who represents IBM and who takes your order.

IBM service representative. An individual who provides field service for IBM products (for example, field maintenance of IBM hardware).

interface. A shared boundary defined by functional characteristics, common physical interconnection characteristics, signal characteristics, and other characteristics, as appropriate.

IPTS. Induced permanent request to send.

K

KEYBOARD/PRINTER menu. One of the setup menus that is used to define the IBM 3151 setup parameters concerning the keyboard operations and the communications with the optional device on the auxiliary port.

L

line-drawing symbols. The symbols that are on the right half of the numeric keypad keys. They are used for drawing lines and making tables.

line speed. The transmission speed of digital signals, usually calculated in bits per second. Also called baud rate.

local mode. A mode in which communications with the host system are disabled.

LTA. Line turnaround character.

M

main port. A port that is used to communicate with the host system.

modem. (1) * (modulator-demodulator) A device that modulates and demodulates signals transmitted over data communication facilities. (2) (TC97) A functional unit that modulates and demodulates signals. One of the functions of a modem is to enable digital data to be transmitted over analog transmission facilities.

N

null character (NUL). (ISO) A control character that is used to accomplish media-fill or time-fill, and that may be inserted into or removed from, a sequence of characters without affecting the meaning of the sequence; however, the control of equipment or the format may be affected by this character.

numeric keypad. A set of keys, located at the right side of the keyboard, that can be used to enter numbers and line-drawing symbols.

NVM. Non-volatile memory.

O

OIA. Operator information area.

online. Pertaining to a user's access to a computer via a terminal or to terminal equipment connected to a transmission line in direct communication action over the line with another terminal or with a computer.

operator information area. The screen area on the bottom line of the screen where messages are displayed to define the status of the terminal or system to the operator.

operator message. A message, displayed in the operator information area, that informs an operator of the operating status of the IBM 3151.

option. See setup parameter.

optional device. A device that is connected to the auxiliary port.

P

padding. A technique by which a receiving station controls the rate of transmission of a sending station to prevent overrun.

page. * A block of data. The IBM 3151 allows only one page to be contained in each partition, therefore, a partition and a page represent the same thing. See partition.

parameter. (1) * (ISO) A variable that is given a constant value for a specified application and that may denote the application. (2) A variable that is

Glossary

given a constant value for a specific document program instruction.

partition. All or a portion of the screen area of a display space and its buffer. Data is presented within the partition through a viewport that is defined when the partition is created. Each viewport has an independent partition.

printer. A device that writes output data from a system on paper or other media.

program. A set of actions or instructions that a machine is capable of interpreting and executing.

program access (PA) key. A key on the keyboard of a display device that produces an interruption to solicit program action.

program function (F1-F36) key. A key on the keyboard of a display device that passes a signal to a program to call for a particular program operation.

protected field. On a display device, a display field in which the user cannot enter, modify, or erase data from the keyboard. Contrast with unprotected field.

PRTS. Permanent request to send.

R

reverse video. A means of highlighting a character or a field by reversing the light intensity between the character and its background; for example, changing a normally black-on-white character to a white-on-black character.

RD. Received data.

RLSD. Received line signal detector. Also called CD (carrier detect).

ROS. Read only storage.

RTS. Request to send.

S

screen format. A format that defines the number of rows and columns of the display screen. The IBM 3151 provides four screen formats: 24 (row) x 80 (column), 24 x 132, 25 x 80, and 25 x 132.

scroll. To move vertically a partition in such a manner that new data appears at one edge as old data disappears at the opposite edge of the viewport.

send mark. A mark, defined by an application program or an operator, that specifies the data area to be sent to the host system or the optional device.

setup menu. A menu that is displayed on the screen and is used to define the IBM 3151 setup parameters. Setup menus include GENERAL, COMMUNICATION, KEYBOARD/PRINTER, and FUNCTION menus. See also setup parameter.

setup parameter. A variable that should be defined to customize the IBM 3151 before operating it. See also setup menu.

setup value. See setup parameter.

T

TD. Transmission data.

***terminal.** (1) A point in a system or network at which data can either enter or leave. (2) A device, usually equipped with a keyboard and a display device, capable of sending and receiving information over a link.

test mode. A mode in which the internal circuits are checked and the test pattern is displayed. This mode is started by the *Test* key.

transmission. (1) The sending of data from one place for reception elsewhere. (2) (TC97) The dispatching of a signal, message, or other form of intelligence by wire, radio, telegraphy, telephony, facsimile, or other means.

transparent mode. A mode in which host commands are handled as character strings.

U

unformatted page. A page in which no field has been defined by an application program. Contrast with formatted page.

unprotected field. On a display device, a display field in which the user can enter, modify, or erase data from the keyboard. Contrast with protected field.

V

viewport. A rectangular area on the usable area of the display surface through which the operator views all or portion of the data. The IBM 3151 can have up to three viewports.

VM. Volatile memory.

X

XOFF. Transmitter off.

XON. Transmitter on.

Glossary

Index**Special Characters**

- + alarm (alm) key 3-4
- <-->AUX 4-10
- >AUX 4-10
- alarm (alm) key 3-4

A

- adjustable legs 1-7
- adjustment
 - audible alarm 2-13
 - positioning the video element 2-12
 - screen brightness 2-11
- alphanumeric keys 3-2
- alternate cursor (Alt Csr) key 3-5
- attribute option 2-26
- auto LF option 2-24
- AUX BUSY 4-4
- AUX NOT READY 4-5
- auxiliary port connector 1-6

B

- back tab (←Tab) key 3-15
- backspace key 3-5
- block mode 2-28
- break key 3-5
- break signal option, main port 2-29
- brightness control knob 1-6

C

- cancel key 3-5
- caps lock key 3-6
- cartridge slot 1-6
- character mode 2-28
- characters option, auxiliary port 2-32
- clear key 3-6
- clear status function 2-34
- COMM NOT READY 1 4-6
- COMM NOT READY 2 4-6
- COMMUNICATION menu 2-27
- connectors
 - auxiliary port 1-6
 - keyboard 1-6
 - main port 1-6
 - power cord 1-6
- control (Ctrl) key 3-6
- CRT saver option 2-24
- CRTS 2-29
- cursor 1-6
- cursor move (↑ ↓ ← →) keys 3-6

D

- default function 2-34
- define function (Def F) key 3-7
- DEL key 3-7
- delete key 3-7
- delete line (Del Ln) key 3-7

Index

E

echo mode 2-28
edit mode option 2-25
emulation
 IBM 3101 A-1
emulation keyboard B-4
emulation keyboard overlay B-2
enhance mode option 2-25
enter key 3-8
enter key option 2-31
erase input (Er Inp) key 3-8
erase to end of field (Erase EOF) key 3-8
erase to end of page (Er EOP) key 3-9
escape (ESC) key 3-9

F

forcing insert option 2-25
function (F1 - F12) key 3-9
function keys 2-38
 how to define 2-38
FUNCTION menu 2-16, 2-33
 clear status function 2-34
 default function 2-34
 mode adjust function 2-34
 recall function 2-34
 reset terminal function 2-34
 save function 2-34
 using 2-16

G

GENERAL menu 2-14, 2-22
 using 2-14

H

HOLD SCREEN 4-6
hold screen (Hold) key 3-10
home key 3-10
HOST BUSY 4-6
host message 4-1

I

IBM 3101 emulation A-1
insert character option 2-31
insert key 3-10
insert line (Ins Ln) key 3-10
INVALID KEY 4-6
IPRTS 2-29

J

jump partition (Jump) key 3-11

K

- key-label mappings
 - ADDS View, print-A2 keyboard B-8
 - ADM-3A keyboard B-7
 - ADM-5 keyboard B-7
 - Hazeltine 1500 keyboard B-8
 - TeleVideo Models 910/910+ keyboard B-11
 - TeleVideo Models 912/920 keyboard B-10
 - TeleVideo Models 925/925E keyboard B-9
- keyboard 1-7
- keyboard connector 1-6
- KEYBOARD ERROR 4-6
- keyboard functions 3-1
- keyboard overlay 1-7
- keyboard without numeric keypad 3-17
- KEYBOARD/PRINTER menu 2-30
- KEYS LOCKED 4-7

L

- line control option, main port 2-29
- line draw key 3-11
- line-drawing symbols 3-2, 3-11
 - using 3-11
- line feed (LF) key 3-11
- line speed option, auxiliary port 2-32
- line speed option, main port 2-28
- line wrap option 2-24
- local key 3-11
- lock command option 2-31

M

- machine mode option 2-23
- main port connector 1-6
- message (Msg) key 3-12
- mode adjust function 2-34
- models 1-2

N

- new line option 2-31
- non-supported functions
 - ADDS VP A2 mode B-12
 - ADM 3A mode B-12
 - ADM 5 mode B-12
 - HZ1500 mode B-13
 - TVI910+/910 mode B-14
 - TVI920E/912 mode B-13
 - TVI925E/925 mode B-13
- non-volatile memory 2-33
- NUMERIC 4-7
- numeric keypad keys 3-2
- NVM (non-volatile memory) 2-33

O

- OIA (operator information area) 1-6
- operating mode 2-28
 - block 2-28
 - character 2-28
 - echo 2-28
- operator information area 1-6, 4-3
- operator information area (OIA) B-15
- operator messages 4-1
 - priority 4-2

Index

overlay, keyboard 1-7
overlay, keyboard emulation B-2

P

padding option, main port 2-29
parity check option, main port 2-29
parity option, auxiliary port 2-32
parity option, main port 2-28
power cord connector 1-6
power switch 1-6
print key 3-12
print line key 3-12
print message (Pr Msg) key 3-12
PRINTING 4-7
PROBLEM IN KEYBOARD 4-7
PROBLEM IN VIDEO ELEMENT OR
KEYBOARD 4-8
program access (PA1 - PA3) key 3-13
PRTS 2-29

R

recall function 2-34
RECEIVING 4-9
reset key 3-13
reset terminal function 2-34
return key 3-13
return key option 2-31
row and column option 2-23

S

save function 2-34
screen option 2-23
scroll option 2-23
send (send line) key option 2-31
send key 3-13
send line key 3-14
send mark 3-12, 3-14
send message (Sn Msg) key 3-14
send null suppress option, main port 2-29
SENDING 4-9
setup key 3-14
setup menus 2-17
 COMMUNICATION menu 2-27
 FUNCTION menu 2-33
 GENERAL menu 2-22
 KEYBOARD/PRINTER menu 2-30
 saving the definitions 2-21
 selecting a field 2-19
 selecting a menu 2-18
 selecting values in the fields 2-20
setup parameters
 attribute 2-26
 auto LF 2-24
 break signal, main port 2-29
 characters, auxiliary port 2-32
 CRT saver 2-24
 edit mode 2-25
 enhance mode 2-25
 enter key 2-31
 forcing insert 2-25
 insert character 2-31
 line control, main port 2-29
 line speed, auxiliary port 2-32
 line speed, main port 2-28
 line wrap 2-24
 lock command 2-31
 machine mode 2-23
 new line 2-31

operating mode 2-28
pacing, main port 2-29
parity check, main port 2-29
parity, auxiliary port 2-32
parity, main port 2-28
return key 2-31
row and column 2-23
screen 2-23
scroll 2-23
send (send line) key 2-31
send null suppress, main port 2-29
stop bit, auxiliary port 2-32
stop bit, main port 2-28
tab 2-25
terminal ID 2-26
turnaround character, main port 2-28
word length, auxiliary port 2-32
word length, main port 2-28
setup parameters list 2-36
setup value 2-14
 how to define 2-14
shift key 3-14
stop bit option, auxiliary port 2-32
stop bit option, main port 2-28
subscript (Sub) key 3-15
subscripts 3-2
superscript (Super) key 3-15
superscripts 3-2

T

tab option 2-25
tab → key 3-15
terminal ID option 2-26
tilt foot 1-6
trace key 3-16
turnaround character option, main port 2-28

V

video element 1-6
VM (volatile memory) 2-33
volatile memory 2-33

W

WAIT 4-9
word length option, auxiliary port 2-32
word length option, main port 2-28
WRONG PLACE 4-9

IBM 3151 ASCII Display Station
Guide to Operations
Order No. GA18-2633-0

**READER'S
COMMENT
FORM**

This manual is part of a library that serves as a reference source for systems analysts, programmers, and operators of IBM systems. You may use this form to communicate your comments about this publication, its organization, or subject matter, with the understanding that IBM may use or distribute whatever information you supply in any way it believes appropriate without incurring any obligation to you.

Your comments will be sent to the author's department for whatever review and action, if any, are deemed appropriate. Comments may be written in your own language; English is not required.

Note: Copies of IBM publications are not stocked at the location to which this form is addressed. Please direct any requests for copies of publications, or for assistance in using your IBM system, to your IBM representative or to the IBM branch office serving your locality.

Your comments:

***Note:* Staples can cause problems with automated mail sorting equipment. Please use pressure sensitive or other gummed tape to seal this form.**

If you would like a reply, please supply your name and address on the reverse side of this form.

Thank you for your cooperation. No postage stamp necessary if mailed in the U.S.A. (Elsewhere, an IBM office or representative will be happy to forward your comments or you may mail directly to the address in the Edition Notice on the back of the title page.)

GA18-2633-0

Reader's Comment Form

CUT
OR
FOLD
ALONG
LINE

Fold and tape

Please Do Not Staple

Fold and tape



NO POSTAGE
NECESSARY
IF MAILED
IN THE
UNITED STATES

BUSINESS REPLY MAIL
FIRST CLASS PERMIT NO.40 ARMONK, N.Y. U.S.A

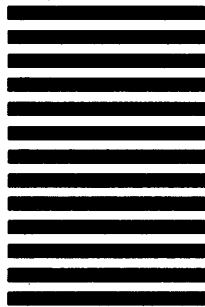

POSTAGE WILL BE PAID BY ADDRESSEE:

INTERNATIONAL BUSINESS MACHINES CORPORATION
DEPARTMENT 6R1J
180 KOST ROAD
MECHANICSBURG, PA 17055

Fold and tape

Please Do Not Staple

Fold and tape

If you would like a reply, please print:

Your Name _____
Company Name _____ Department _____
Street Address _____
City _____
State _____ Zip Code _____
IBM Branch Office serving you _____



International Business Machines Corporation

Armonk, New York 10504

Exhibit to IBM Statement of Limited Warranty

IBM 3151 ASCII Display Terminal Limited Warranty

IF YOU PURCHASED THE IBM 3151 ASCII DISPLAY STATION (MACHINE) DIRECTLY FROM INTERNATIONAL BUSINESS MACHINES CORPORATION (IBM), OR ANOTHER IBM ORGANIZATION, UNDER AN AGREEMENT FOR PURCHASE OF IBM MACHINES, THE WARRANTY PROVISIONS THEREIN SHALL PREVAIL AND THIS EXHIBIT AND THE ENCLOSED STATEMENT OF LIMITED WARRANTY SHALL NOT APPLY.

WARRANTY SERVICE DESCRIBED IN THE ENCLOSED STATEMENT OF LIMITED WARRANTY IS AVAILABLE ONLY FOR MACHINES PURCHASED AND LOCATED IN THE UNITED STATES OR PUERTO RICO.

IF YOU PURCHASED THIS MACHINE FROM A SUPPLIER AUTHORIZED BY AN IBM ORGANIZATION TO MARKET THIS MACHINE IN OTHER THAN THE UNITED STATES OR PUERTO RICO, WARRANTY INFORMATION IS AVAILABLE FROM SUCH SUPPLIER.

I. Date of Installation (Warranty Start Date):

The Date of Installation, which is the start date, will be the day (Monday through Friday) following the date of delivery of the Machine to you from an IBM Authorized Dealer, an IBM Authorized Distributor or a Reseller who purchased the Machine from such Distributor, as applicable. Delivery is deemed to be complete when the Machine is placed in your possession; however, when the Machine is shipped to you, delivery will be deemed to be complete three days after the date of shipment from an IBM Authorized Dealer, an IBM Authorized Distributor or a Reseller who purchased the Machine from such Distributor, as applicable. You are responsible to set up this Machine in accordance with the instructions furnished by IBM.

II. Warranty Duration:

3 years

III. Type of Service:

Customer Carry-in Exchange (CCE)

IV. Period of Warranty Service Availability:

When rendered by IBM, is available during the normal business hours of the applicable IBM Service/Exchange Center. When rendered by an IBM Authorized Dealer or an IBM Authorized Distributor, is available during the hours and days prescribed by such Dealer or Distributor.

V. Provider of Warranty Service:

IBM or the IBM Authorized Dealer or IBM Authorized Distributor from whom the Machine was purchased.

There is enclosed the IBM Statement of Limited Warranty.

You may be required to provide a dated proof of purchase of this Machine from the IBM Authorized Dealer, the IBM Authorized Distributor or the Reseller who purchased this Machine from such Distributor and evidence of the date of delivery to you in order to obtain warranty service. If you have any questions regarding warranty service, contact your point of purchase, or call IBM at 1-800-428-2569.

The following Warranty Option is available, for three year warranted machines, for a charge, under the IBM Maintenance Agreement.

IBM On-Site Exchange (IOE)

International Business Machines Corporation

Armonk, New York 10504

Statement of Limited Warranty

DEFINITIONS

The term "Machine" as used herein refers to machines and/or their features, model conversions, machine elements and accessories unless the context requires individual reference.

The terms "Machines" and "machines" are used in substitution for the terms "Products" and "products," respectively. Such latter terms appear in selected IBM agreements.

The term "failing machine" refers to machine or machine element requiring warranty service. The term "exchange machine" refers to a machine or machine element provided by IBM to the Customer under an Exchange Type of Service.

The term "programming" shall mean such programming as IBM may make generally available, without separate charge, for machines of the types ordered by the Customer.

WARRANTIES

Machines purchased from IBM under an agreement for purchase of IBM machines or from an IBM approved Remarketer, or an IBM Authorized Dealer, Distributor or Wholesaler will be 1) newly manufactured by or for IBM from new and serviceable used parts which are equivalent to new in performance in these Machines, 2) assembled by or for IBM from serviceable used parts, or 3) Machines which have been previously installed.

IBM warrants that on the Date of Installation each Machine will be in good working order and will conform to IBM's official published specifications which are available upon request.

The Warranty Period for each Machine commences on its Date of Installation.

Warranty service as described herein may be provided by IBM, an applicable IBM Authorized Dealer, or an IBM selected independent contractor, as indicated in the applicable Exhibit.

IBM will not provide warranty service hereunder for Machines or programming located outside the United States and Puerto Rico.

Service and Parts Warranty

Commencing on the Date of Installation of each machine, model upgrade and feature addition, and continuing for the duration of the Warranty Period, IBM agrees to provide the availability of warranty service at no

additional charge except as set forth in this subsection or in the subsection entitled "Travel Expense," to keep the machines, model upgrades and feature additions in, or restore them to, good working order. Warranty service will be provided by repairing the machines, model upgrades or feature additions or exchanging the machines under one of the Types of Service described in the subsection entitled "Types of Service." The specific Type of Service for each machine, model upgrade or feature addition will be indicated in the applicable Exhibit. Warranty options that provide alternate Types of Service are available for certain Machines under an IBM maintenance agreement.

It is the Customer's responsibility to determine when a machine or machine element requires warranty service. Before requesting warranty service, the Customer will perform any problem determination procedures provided by IBM, and if service is required, the Customer will follow the service request procedures provided by IBM.

When the Customer presents a failing machine to IBM under a Repair Type of Service, IBM will provide warranty service to restore the failing machine to good working order. Repair Types of Service include remedial maintenance and may include preventive maintenance based on the specific needs of individual machines as determined by IBM. Repair Types of Service may also include lubrication, adjustments and replacement of parts, all as deemed necessary by IBM. Parts, which may be used parts, will be furnished on an exchange basis, and the replaced parts become the property of IBM. When a failing machine is to be repaired under a Repair Type of Service, the Customer is responsible to remove or implement other safeguards to protect all programming, programs, data and removable storage media before such repair.

When the Customer presents a failing machine to IBM under an Exchange Type of Service, it becomes the property of IBM at the time of exchange. An exchange machine may not be new, but will be in good working order, and becomes the Customer's property at the time of exchange. IBM reserves the right to verify that warranty service for a failing machine is required prior to providing an exchange machine. When a failing machine is exchanged, the Customer will remove all programming, programs, data and removable storage media, and all non-IBM parts, options, alterations and attachments before such exchange. The Customer agrees that all such

items not removed will be deemed to have been discarded by the Customer. The Customer will not present to IBM a failing machine for exchange which is defaced, altered or damaged beyond repair. (Repair is as described in the preceding paragraph.) However, if upon inspection IBM determines it has received in exchange a failing machine in such condition, the exchange will be nullified and each party will return to the other the machine or machine element in its possession.

The Period of Warranty Service Availability for IBM On-Site Repair and IBM On-Site Exchange Types of Service are specified in the applicable Exhibit. Outside such Period, warranty service, if requested by the Customer and provided by IBM, will be subject to charge for travel expense plus travel, waiting and service time at IBM's then applicable hourly service rates and minimum charges: however, there will be no additional charges for parts.

The Period of Warranty Service Availability for Customer On-Site Exchange, Customer Carry-In Exchange and Customer Carry-In Repair Types of Service are specified in the applicable Exhibit.

Warranty service described herein does not assure uninterrupted operation of the Machines. IBM may, at its option, store on the Customer's premises maintenance equipment and/or parts that IBM deems necessary to fulfill this warranty.

During the Warranty Period, engineering changes, determined applicable by IBM, will be controlled by IBM and installed as specified by IBM on the Machines. The Customer may, by providing notice subject to written confirmation by IBM, elect to have only mandatory changes, as determined by IBM, installed on Machines so designated.

IBM shall have full, free and safe access to the Machines to provide IBM On-Site Types of Service thereon. The Customer shall promptly inform IBM of any change in a Machine's location during the Warranty Period.

In respect to warranty service provided by IBM, the Customer is responsible for all risk of loss of, or damage to, Machines owned by other than IBM during the period such Machines are in transit to and from IBM, except for loss or damage caused by IBM's negligence. However, IBM is responsible for risk of loss of, or damage to, Machines owned by other than IBM while in possession of IBM or in transit from IBM by an IBM selected carrier whose expenses were prepaid by IBM.

The Customer represents and warrants that, at the time a failing machine becomes IBM's property, it will be free of any outstanding liens, security interests or other encumbrances held by any third party.

If the Warranty Period expires on a Friday or Saturday, it will be extended so that the last day of such Warranty Period will be on the following Sunday.

Types of Service

IBM On-Site Repair (IOR)

IBM will provide warranty service for the failing machine at the Customer's location.

IBM On-Site Exchange (IOE)

IBM will 1) deliver the exchange machine to the Customer's location, 2) disconnect the failing machine, 3) connect the exchange machine, 4) verify its operation, and 5) remove the failing machine from the Customer's location.

Customer On-Site Exchange (COE)

IBM will have an exchange machine delivered to the Customer's location. The Customer will 1) disconnect the failing machine and prepare it for shipment to IBM, 2) connect the exchange machine, and 3) verify its operation. The Customer will follow IBM's instructions regarding the shipment of the failing machine to IBM. Such shipment will be at IBM's expense.

Customer Carry-In Exchange (CCE)

The Customer will 1) deliver the failing machine to an IBM Service/Exchange Center or other IBM designated location, 2) pick up the exchange machine and take it to the Customer's location, 3) connect it, and 4) verify its operation.

The Customer, in lieu of such delivery and pick up, may ship the failing machine prepaid, in the original shipping container or equivalent, to one of the designated IBM Service/Exchange Centers designated for this delivery method. IBM will then ship the exchange machine to the Customer's locations, prepaid, within the United States and Puerto Rico.

Customer Carry-In Repair (CCR)

The Customer will 1) deliver the failing machine to an IBM Service/Exchange Center or other IBM designated location, 2) when the failing machine is repaired, pick it up and return it to the Customer's location, 3) connect it, and 4) verify its operation.

The Customer, in lieu of such delivery and pick up, may ship the failing machine prepaid, in the original shipping container or equivalent, to one of the IBM Service/Exchange Centers designated for this delivery method. IBM will ship the repaired machine to the Customer's location, prepaid, within the United States and Puerto Rico.

Programming

IBM warrants that, when shipped to the Customer, programming designated by IBM for use with a Machine and for which programming services are available will conform to IBM's official published specifications which are available upon request.

IBM does not warrant that functions contained in programming will operate in the combinations which may be selected for use by the Customer or will meet the Customer's requirements.

ALL OTHER PROGRAMMING IS DISTRIBUTED ON AN "AS IS" BASIS.

Additional Provisions for Features and Model Conversions

IBM's warranty for each feature addition or model upgrade requires that the machine on which it is installed is at the then current engineering-change level, is the specific serial-numbered machine for which it was ordered and has been modified only with changes obtained from IBM specifically for that serial-numbered machine. If these conditions are not met, IBM will attempt to install non-Customer set-up feature additions and model upgrades on the machine, and, if such attempt results in an incorrectly functioning machine, upon Customer request and at IBM's then applicable hourly service rates and minimum charges, parts and material prices and travel expense, IBM will remove the features and/or model upgrades and restore the machine to its prior condition. If such features or model upgrades did not involve the removal of parts which became the property of IBM, such features and model upgrades remain the property of the Customer. If such features and model upgrades did involve the removal of parts which became the property of IBM, such features and model upgrades become the property of IBM and the restored parts become the property of the Customer.

For a feature removal, model downgrade or reinstallation of a previously purchased feature or model conversion, a three-month parts warranty will apply to additional parts, if any, supplied by IBM.

Additional Provisions for Accessories

Accessories have a three-month Warranty Period unless otherwise specified by IBM. During the Warranty Period, the Customer will remove any defective or failing accessory and ship it prepaid to the designated IBM location. IBM will replace such accessory and ship the replacement to the Customer without charge.

Additional Provisions for Machines Containing Funds

The Customer is responsible for removing, controlling and replacing or reloading funds contained in the Machines. IBM will service Machines containing funds only when the cash container cannot be opened prior to repair by IBM, in which case the Customer will remove the funds as soon as the container has been opened.

Services for Additional Charge During the Warranty Period

The services for additional charge described in this subsection are not warranty services. However, unless

such services are provided under another written agreement between the Customer and IBM, during the Warranty Period, the following services, if available, will be provided by IBM to the Customer at IBM's i) then generally available hourly service rates and minimum charges for IBM service time, including travel and waiting time, ii) parts and material prices then generally in effect, and iii) charges for travel and shipping expense, all as applicable;

- 1) Repair of Machine damage, replacement of parts or increase in service time caused by --
 - a) failure to continually provide a suitable environment prescribed by IBM including adequate space, electrical power, air conditioning and humidity control;
 - b) neglect; misuse, including use of the Machines for purposes other than for which designed;
 - c) accident; disaster, including water, wind and lightning, transportation; vandalism or burglary;
 - d) alterations, including any deviation from IBM's Machine design;
 - e) attachments, including any interconnection to the Machine of non-IBM equipment or devices not under an IBM maintenance agreement;
 - f) IBM Machines, other Machines or accessories, except those IBM Machines, other Machines or accessories that are owned by IBM, under warranty from IBM or under an IBM maintenance agreement;
 - g) conversions from one IBM model to another or installation or removal of an IBM feature whenever any of these activities was performed by other than IBM, except that this item (g) will apply only during the first three-month period subsequent to such Machine modification; and
 - h) maintenance or repair of the Machine not performed by IBM.
- 2) Repair of Machine damage, replacement of maintenance parts (due to other than normal wear) or repetitive service calls caused by the use of, inadequate use of, or failure to use, supplies;
- 3) Service for accessories other than as provided in the subsection entitled "Additional Provisions for Accessories" of this Section;
- 4) Inspection of altered Machine;
- 5) Replacement or addition of parts and increase in service time associated with the installation by IBM of an engineering change, required due to the conversion of one IBM model to another or installation or removal of an IBM feature whenever any of these activities was performed by other than IBM;

- 6) Rearrangement or relocation of Machines and provision of necessary materials; and
- 7) Replacement of a part not furnished for the Machine by IBM with a directly interchangeable IBM maintenance part, and any increase in service time associated with such activity, except that IBM will not replace any part which is included in an alteration.

Travel Expense

There will be no charge for travel expense associated with warranty service or programming service during the applicable Period of Warranty Service Availability except that actual travel expense will be charged when the site at which the Machine is located is normally inaccessible by both private automobile and scheduled public transportation.

Exclusions

The warranties stated herein do not include 1) furnishing supplies, painting or refinishing the Machines or furnishing material therefor, 2) electrical work external to the Machines, 3) installation, maintenance or removal of alterations or attachments to the Machines, and 4) any service which is impractical for IBM to render because of alterations in, or attachments to the Machines. IBM does not warrant that the operation of Machines or programming will be uninterrupted or error free or that all programming errors will be corrected.

THE FOREGOING WARRANTIES ARE IN LIEU OF ALL OTHER WARRANTIES, EXPRESS OR IMPLIED, INCLUDING, BUT NOT LIMITED TO THE IMPLIED WARRANTIES OF MERCHANTABILITY AND FITNESS FOR A PARTICULAR PURPOSE.

