



# **MUXserver 320**

## **Hardware Installation Manual**

Order Number EK-DSRZE-IM

---

---

**First Edition, February 1992**

The information in this document is subject to change without notice and should not be construed as a commitment by Digital Equipment Corporation (Australia) Pty. Limited. Digital Equipment Corporation (Australia) Pty. Limited assumes no responsibility for any errors that may appear in this document.

The software described in this document is furnished under a license and may be used or copied only in accordance with the terms of such license.

No responsibility is assumed for the use or reliability of software on equipment that is not supplied by Digital Equipment Corporation (Australia) Pty. Limited or its affiliated companies.

---

Copyright ©1992 by Digital Equipment Corporation (Australia) Pty. Limited.


All Rights Reserved.

Printed in Australia.

---

The postpaid READER'S COMMENTS form on the last page of this document requests the user's critical evaluation to assist in preparing future documentation.

The following are trademarks of Digital Equipment Corporation:

|              |           |   |
|--------------|-----------|---|
| DEC          | DIBOL     | UNIBUS  |
| DEC/CMS      | EduSystem | UWS   |
| DEC/MMS      | IAS       | VAX   |
| DECnet       | MASSBUS   | VAXcluster  |
| DECstation   | PDP       | VMS   |
| DECsystem-10 | PDT       | VT  |
| DECSYSTEM-20 | RSTS      |   |
| DECUS        | RSX       |   |
| DECwriter    | ULTRIX    |  |

# Contents

---

## Preface

viii

---

## Chapter 1 Introduction

---

|       |   |      |
|-------|---|------|
| 1.1   | Overview of the MUXserver 320 Network         | 1-1  |
| 1.2   | Typical MUXserver 320 Network Configuration   | 1-2  |
| 1.3   | The MUXserver 320                             | 1-3  |
| 1.4   | Connecting the MUXserver 320                  | 1-6  |
| 1.5   | Installation Overview                         | 1-9  |
| 1.6   | Items Required for MUXserver 320 Installation | 1-10 |
| 1.7   | Service Options                               | 1-11 |
| 1.7.1 | Digital On-Site Service                       | 1-12 |
| 1.7.2 | Installation Service                          | 1-12 |
| 1.7.3 | Software Product Service Agreements           | 1-12 |
| 1.7.4 | Training                                      | 1-12 |

## Chapter 2 Quick Installation Guide

---

|     |   |     |
|-----|---|-----|
| 2.1 | Associated Preliminary Activities           | 2-1 |
| 2.2 | Preparing the MUXserver 320                 | 2-1 |
| 2.3 | Site Preparation                            | 2-2 |
| 2.4 | Hardware Installation                       | 2-2 |
| 2.5 | Testing the MUXserver 320 Hardware          | 2-2 |
| 2.6 | Connecting the MUXserver 320 to the Network | 2-2 |
| 2.7 | Completing the Installation                 | 2-3 |
| 2.8 | Installation Difficulties                   | 2-3 |
| 2.9 | Associated Subsequent Activities            | 2-3 |

## Chapter 3 Preparing the MUXserver 320

---

|       |   |     |
|-------|---|-----|
| 3.1   | Unpacking the MUXserver 320 .....                 | 3-1 |
| 3.2   | Unpacking the Accessories .....                   | 3-1 |
| 3.3   | Unpacking the Country Kit .....                   | 3-2 |
| 3.4   | Pre-Installation Checks .....                     | 3-2 |
| 3.4.1 | Verifying the Voltage Select Switch Setting ..... | 3-2 |
| 3.4.2 | Site Preparation .....                            | 3-3 |

## Chapter 4 Site Verification

---

|       |  |     |
|-------|--|-----|
| 4.1   | Ventilation .....                            | 4-1 |
| 4.2   | Environmental Conditions .....               | 4-1 |
| 4.3   | Power Supply .....                           | 4-2 |
| 4.4   | Cabling Requirements .....                   | 4-2 |
| 4.4.1 | Standard Ethernet Connection .....           | 4-3 |
| 4.4.2 | ThinWire Ethernet Connection .....           | 4-3 |
| 4.4.3 | Power Cable .....                            | 4-3 |
| 4.4.4 | Maximum Serial Communication Distances ..... | 4-3 |
| 4.5   | Acoustic Noise Levels .....                  | 4-4 |

## Chapter 5 Hardware Installation

---

|       |   |      |
|-------|---|------|
| 5.1   | Re-check the Voltage Select Switch Setting .....          | 5-1  |
| 5.2   | Installation .....  | 5-1  |
| 5.2.1 | Desk Top Installation .....                               | 5-1  |
| 5.2.2 | Wall Mounted Installation .....                           | 5-1  |
| 5.2.3 | Rack Mounted Installation .....                           | 5-1  |
| 5.2.4 | Satellite Equipment Room .....                            | 5-3  |
| 5.3   | Testing the MUXserver 320 Hardware .....                  | 5-3  |
| 5.3.1 | Selecting ThinWire Ethernet .....                         | 5-4  |
| 5.3.2 | Connecting the ThinWire T-Connector and Terminators ..... | 5-4  |
| 5.3.3 | Connecting Power to the MUXserver 320 .....               | 5-5  |
| 5.3.4 | Running Self-Test .....                                   | 5-6  |
| 5.4   | Connecting to the Ethernet LAN .....                      | 5-8  |
| 5.4.1 | Connecting to the ThinWire Ethernet LAN .....             | 5-9  |
| 5.4.2 | Connecting to The Standard Ethernet LAN .....             | 5-10 |
| 5.5   | Connecting a Terminal to the Console Port .....           | 5-12 |
| 5.6   | Connecting Synchronous Link Cables .....                  | 5-14 |
| 5.6.1 | Connecting a Modem to a 50-Pin Connector .....            | 5-14 |
| 5.6.2 | Connecting a Co-located DECMUX 300 .....                  | 5-17 |
| 5.6.3 | Connecting a Modem to a 25-Pin Connector .....            | 5-17 |

|     |                               |      |
|-----|-------------------------------|------|
| 5.7 | Connecting Power .....        | 5-19 |
| 5.8 | Running Self-Test .....       | 5-20 |
| 5.9 | Installation Completion ..... | 5-20 |

## Chapter 6 Installation Difficulties

---

|       |  |     |
|-------|--|-----|
| 6.1   | The 7-Segment Display .....                            | 6-1 |
| 6.1.1 | Diagnostic Dot Off .....                               | 6-2 |
| 6.1.2 | Diagnostic Dot Blinking .....                          | 6-2 |
| 6.1.3 | 7-Segment Display Off and Green Ethernet LED OFF ..... | 6-2 |
| 6.1.4 | 7-Segment Display Shows "3" .....                      | 6-3 |
| 6.1.5 | 7-Segment Display Flashing .....                       | 6-3 |
| 6.2   | Error Messages .....                                   | 6-3 |
| 6.2.1 | Error Message 1003 .....                               | 6-3 |
| 6.2.2 | Error Message 1007 .....                               | 6-3 |
| 6.2.3 | Error Message 1008 .....                               | 6-4 |
| 6.2.4 | Error Message 1010 .....                               | 6-4 |
| 6.2.5 | Error Message 1011 .....                               | 6-4 |
| 6.2.6 | Error Message 1012 .....                               | 6-5 |
| 6.3   | Down-Line Load Problems .....                          | 6-5 |
| 6.3.1 | Down-Line Load Starts, Then Fails .....                | 6-5 |
| 6.3.2 | Down-Line Load Does Not Start .....                    | 6-5 |

## Appendix A Connector Pin Descriptions

---

|     |                                      |     |
|-----|--------------------------------------|-----|
| A.1 | Ethernet Transceiver Interface ..... | A-1 |
| A.2 | 25-Pin D-Type Connector .....        | A-2 |
| A.3 | 50-Pin D-Type Connector .....        | A-3 |
| A.4 | Supervisor Port Connector .....      | A-5 |

## Appendix B Ordering Information

---

|       |  |     |
|-------|--|-----|
| B.1   | Products in the MUXserver 320 Network .....    | B-1 |
| B.2   | Country Kits .....                             | B-2 |
| B.3   | MUXserver 320 Accessories .....                | B-3 |
| B.4   | MUXserver 320 Software Distribution Kits ..... | B-3 |
| B.5   | Cables .....                                   | B-3 |
| B.6   | Documentation .....                            | B-3 |
| B.6.1 | VMS Software Documentation Kit .....           | B-3 |
| B.6.2 | ULTRIX Software Documentation Kit .....        | B-4 |
| B.6.3 | Hardware Documents .....                       | B-4 |
| B.7   | Ordering Procedures .....                      | B-4 |

## Appendix C Instructions For UK Installations

---

|     |   |     |
|-----|---|-----|
| C.1 | Service Category Specifications .....                           | C-1 |
| C.2 | Direct Connection (BAPT/SITS/89/43 Section 4.2) .....           | C-2 |
| C.3 | Apparatus Between MUXserver 320 and Digital Circuit (PTT) ..... | C-2 |
| C.4 | Safety Warning for UK Installations .....                       | C-2 |

## GLOSSARY

---

### Index

---

### Figures

---

|      |  |      |
|------|--|------|
| 1-1  | MUXserver 320 Network Configuration Principles .....             | 1-3  |
| 1-2  | MUXserver 320 Model DSRZE-XX .....                               | 1-4  |
| 1-3  | MUXserver 320 Controls, Indicators and Connectors .....          | 1-4  |
| 1-4  | Standard Ethernet Coaxial Cable Connection .....                 | 1-6  |
| 1-5  | ThinWire Ethernet Coaxial Cable Connection .....                 | 1-7  |
| 1-6  | Synchronous Link Connections .....                               | 1-8  |
| 1-7  | Supervisor Port Connection .....                                 | 1-9  |
| 1-8  | MUXserver 320 Installation Activities .....                      | 1-10 |
| 3-1  | Supply Voltage Label .....                                       | 3-2  |
| 3-2  | Supply Voltage Select Switch .....                               | 3-3  |
| 5-1  | Removing the Protective Covers .....                             | 5-2  |
| 5-2  | Rack Mounting the MUXserver 320 .....                            | 5-3  |
| 5-3  | Selecting ThinWire Ethernet .....                                | 5-4  |
| 5-4  | Connecting the ThinWire T-Connector and Terminators .....        | 5-5  |
| 5-5  | Connecting Power to the MUXserver 320 .....                      | 5-6  |
| 5-6  | 7-Segment Display .....  | 5-7  |
| 5-7  | Connecting to the ThinWire Ethernet LAN .....                    | 5-10 |
| 5-8  | Unlocking the Slide Latch .....                                  | 5-11 |
| 5-9  | Connecting the Transceiver Cable .....                           | 5-11 |
| 5-10 | Connecting to the Supervisor Port Connector .....                | 5-12 |
| 5-11 | Connecting to the Terminal .....                                 | 5-13 |
| 5-12 | Connecting to 25-Pin D-type Connector Terminal .....             | 5-14 |
| 5-13 | Connecting to the 50-Pin D-Type Connector .....                  | 5-16 |
| 5-14 | Connecting the Adaptor Cable and Extension Cable .....           | 5-16 |
| 5-15 | Connecting a V24/EIA-232-D Adaptor .....                         | 5-17 |
| 5-16 | Connecting a BC22F-xx Extension Cable to the MUXserver 320 ..... | 5-18 |
| 5-17 | Connecting the V24/EIA-232-D Adaptor .....                       | 5-19 |
| 5-18 | Connecting Power to the MUXserver 320 .....                      | 5-20 |

## Tables

---

|     |   |      |
|-----|---|------|
| 1-1 | MUXserver 320 Controls                                  | 1-5  |
| 1-2 | MUXserver 320 Indicators                                | 1-5  |
| 1-3 | MUXserver 320 Connectors                                | 1-5  |
| 1-4 | Synchronous Link Speeds                                 | 1-8  |
| 4-1 | Physical Specifications                                 | 4-1  |
| 4-2 | Environmental Specifications                            | 4-2  |
| 4-3 | Electrical Specifications                               | 4-2  |
| 4-4 | Maximum Cable Lengths                                   | 4-3  |
| 4-5 | Maximum Serial Communication Distances                  | 4-4  |
| 4-6 | Acoustic Noise Levels                                   | 4-4  |
| 5-1 | 7-Segment Display                                       | 5-8  |
| 5-2 | Synchronous Link Adaptor and Extension Cables           | 5-15 |
| 6-1 | 7-Segment Display Indications                           | 6-2  |
| A-1 | Standard Ethernet Transceiver Interface Pin Description | A-1  |
| A-2 | 25-Pin D-Type Connector Pin Description                 | A-2  |
| A-3 | 50-Pin D-Type Connector Pin Description                 | A-3  |
| A-4 | Pin Descriptions for Serial Communication Interface     | A-5  |
| B-1 | MUXserver 320 Product Family                            | B-1  |
| C-1 | Specifications for Service Categories                   | C-1  |



# Preface

---

## Purpose of the Manual

This manual describes the environmental requirements of the MUXserver 320 Remote Terminal Server and its installation.

## Intended Audience

This manual is intended for readers responsible for installing the MUXserver 320 Remote Terminal Server.

## Structure of the Manual

This manual is organized as follows:

- Chapter 1     Introduces the MUXserver 320 Remote Terminal Network and its family of products.
- Chapter 2     Summarizes the MUXserver 320 hardware installation activities and presents a quick-reference guide for the more experienced installer.
- Chapter 3     Describes the unpacking and preparation of a MUXserver 320 before its installation.
- Chapter 4     Describes checks to ensure that the selected installation site for a MUXserver 320 has been correctly prepared.
- Chapter 5     Describes the detailed procedures for installing and testing a MUXserver 320. Planning and installation of the entire MUXserver 320 Remote Terminal Network is described in the *MUXserver 320/380 Network Reference Manual*. Installation of the network's remote DECmux 300s is described in the *MUXserver /DECmux 300 Network Installation Manual*.

|                   |   |
|-------------------|---|
| <b>Chapter 6</b>  | Describes the problems that may be encountered during MUXserver 320 installation and suggests possible corrective action. |
| <b>Appendix A</b> | Describes the pins of the MUXserver 320 hardware connectors.  |
| <b>Appendix B</b> | Lists the ordering codes for the MUXserver 320 products.  |
| <b>Appendix C</b> | Contains instructions which must be observed when the MUXserver 320 is being installed in the United Kingdom.             |
| <b>Glossary</b>   | Defines all abbreviations and special terms used in this manual.  |
| <b>Index</b>      | Provides a page reference to the important topics used in this manual.  |

## Other MUXserver 320 Publications

Other MUXserver 320 publications, which might be required during installation, include:

|  |             |
|--|-------------|
| <i>MUXserver 320/380 Software Installation Guide for VMS</i>   | AA-PESDA-TE |
| Describes installing the MUXserver 320 software onto a VAX/VMS System.   |             |
| <i>MUXserver 320/380 Software Installation Guide for ULTRIX</i>  | AA-PEUUA-TE |
| Describes installing the MUXserver 320 software onto a VAX or RISC ULTRIX system.  |             |
| <i>MUXserver 320/380 Network Reference Manual</i>  | AA-PESEA-TE |
| Describes planning, installing, setting up and management of a MUXserver 320 network.  |             |
| <i>MUXserver 320/380 Network Identification Card</i>   | EK-DSRZD-IC |
| Records MUXserver 320 installation details, including  |             |
| <ul style="list-style-type: none"> <li>• Local equipment locations and identification information,</li> <li>• Remote equipment locations and identification information, and</li> <li>• Synchronous link details.</li> </ul> |             |

### Notes

1. The *MUXserver 320 Hardware Installation Manual* (this manual) and the *MUXserver 320/380 Network Identification Card* are delivered with each MUXserver 320 hardware product.
2. The *MUXserver 320/380 Network Reference Manual*, *Release Notes* and the relevant *Software Installation Guide* are delivered with each MUXserver 320 software distribution kit.
3. Additional copies of these documents may be ordered from Digital Equipment Corporation.

## Other Relevant Publications

Reference to the following Digital Equipment Corporation publications may be required during installation of the MUXserver 320 network:

|   |              |
|---|--------------|
| <i>MUXserver/DECmux 300 Network Installation Manual.</i>  | EK-DSRZC-IM  |
| Describes the installation of the MUXserver 320 Network's remote unit - the DECmux 300  |              |
| <i>DECconnect System Planning and Configuration Guide</i>   | EK-DECSYS-CG |
| Describes the planning and configuration of a DECconnect System network.  |              |
| <i>DECconnect System Facilities Cabling Installation Guide</i>  | EK-DECSYS-FC |
| Describes the procedures for installing cables for a DECconnect System network.   |              |
| <i>DECconnect System General Description</i>  | EK-DECSY-GD  |
| Provides an overview of the DECconnect System products and services.  |              |
| <i>Telecommunications and Networks Buyer's Guide</i>  |              |
| Provides a comprehensive description of Digital Equipment Corporation's networking and communications products, including ordering information. |              |

### Notes

1. The *MUXserver/DECmux 300 Network Installation Manual* is delivered with each DECmux 300.
2. Additional copies, and copies of other manuals, may be ordered from Digital Equipment Corporation.

## Conventions

Throughout this manual:

- The overall MUXserver 320 Remote Terminal Server network is referred to as the **MUXserver 320 Network**,
- The Local Unit component of the MUXserver 320 Network (the MUXserver 320 Remote Terminal Server) is referred to as the **MUXserver 320**, and
- The Remote Unit component of the MUXserver 320 Network (the DECmux 300 Remote Terminal Multiplexer) is referred to as the **DECmux 300**.

Also in this manual, Notes, Cautions and Warnings have the following meanings:

- |                |  |
|----------------|--|
| <b>Note</b>    | The associated information is important to the understanding of the activities being described.      |
| <b>Caution</b> | Incorrect application of the associated information can cause equipment damage.                      |
| <b>Warning</b> | Incorrect application of the associated information can cause injury to the user or to other people. |

## UK Installations

Instructions contained in Appendix C must be observed when the MUXserver 320 product is being installed in the United Kingdom.

## FCC Notice

The equipment described in this manual generates, uses and may emit radio frequency energy. The equipment has been type tested and found to comply with the limits for a Class A computing device pursuant to Subpart J Part 15 of FCC Rules, which are designed to provide reasonable protection against such a radio frequency interface when operated in a commercial environment.

Operation of this equipment in a residential area may cause interference, in which case the user at his own expense may be required to take measures to correct the interference.

## Hazardous Voltages

### WARNING

Ethernet installations may extend to thousands of metres and involve many separate items of equipment. To prevent hazardous voltages appearing on the installation, it is important that all the equipment be part of a common equipotential system as defined in IEC publications 364-4-41 clauses 413.1.2 and 413.1.6. Where it is required to couple equipment outside of the main equipotential bonded area via Ethernet, then optical repeaters or other such galvanically isolated measures must be employed. If in doubt, refer to Digital Equipment Corporation for advice.



# Chapter 1

---

## Introduction

### 1.1 Overview of the MUXserver 320 Network

The MUXserver 320 Remote Terminal Network connects remote terminals (or other asynchronous port devices) to an Ethernet Local Area Network (LAN).

The network includes one MUXserver 320 Remote Terminal Server which is connected to the host computer system via an Ethernet Local Area Network (LAN). The network supports up to 32 active remote asynchronous terminals or printers, via synchronous links and remote terminal multiplexers as follows:

- Up to two synchronous links are supported by the MUXserver 320 - one at up to 64Kbps and one at up to 19.2Kbps.
- Up to three DECmux 300 remote terminal multiplexers may be connected, via modems, in a daisy-chain fashion to each synchronous link. The total MUXserver 320 network is limited to six DECmux 300s.
- Depending on its particular model and configuration, each DECmux 300 may have 4, 8, 16 or 32 asynchronous ports.
- The total number of asynchronous devices attached to the MUXserver 320 network is limited only by the available asynchronous ports on the DECmux 300s.
- The number of active users is limited to 32.
- The number of sessions is limited to 128.

The network connects each remote terminal to the host LAN with access to certain LAT and INTERNET services offered by the LAN.

The *MUXserver 320/380 Network Reference Manual* describes the features of the MUXserver 320 remote terminal network.

The MUXserver 320 product family consists of two variants of the MUXserver 320 and eight variants of the DECmux 300 which are listed in Table B-1.

## 1.2 Typical MUXserver 320 Network Configuration

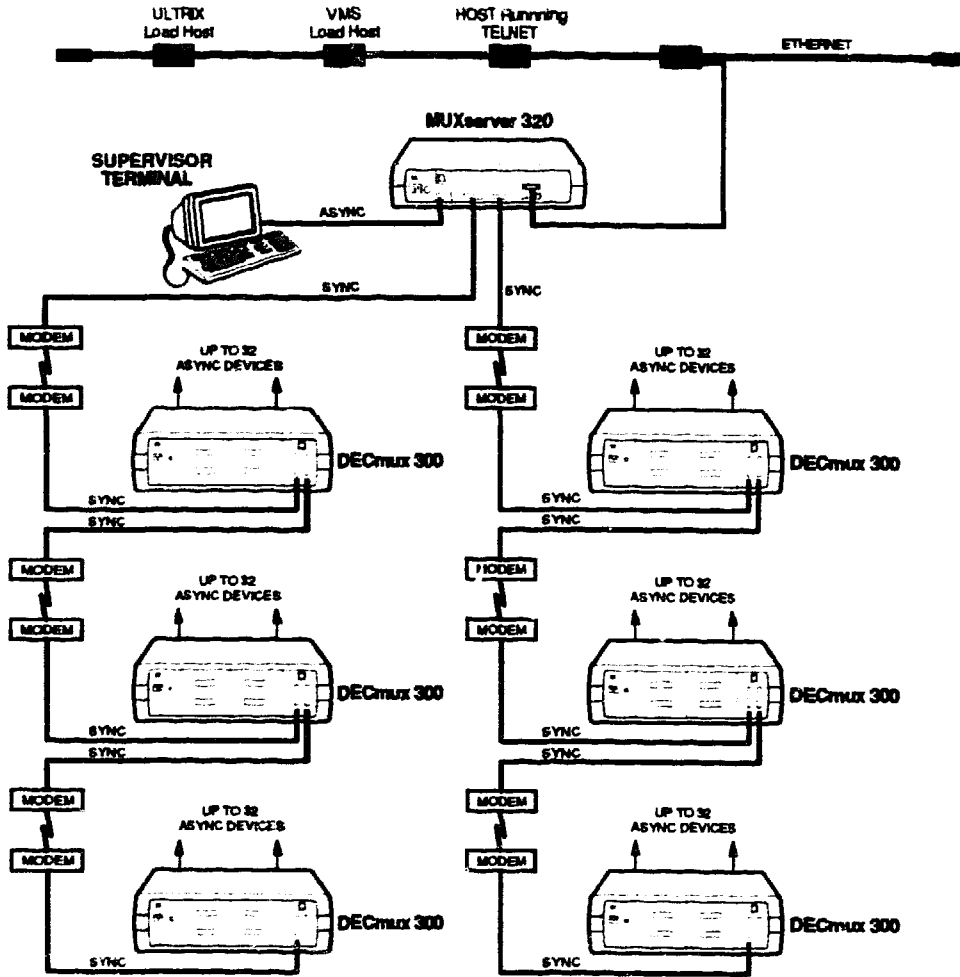
Figure 1-1 illustrates the configuration principles of a MUXserver 320 network. It shows:

- One MUXserver 320 connected to either an ULTRIX load host or VMS load host via an Ethernet local area network,
- A console terminal connected to the MUXserver 320's Supervisor port.
- Up to two synchronous links serviced by the MUXserver 320,
- Up to three DECmux 300s connected, in daisy-chain fashion, to each synchronous link. Thus the total MUXserver 320 network is limited to six DECmux 300s.

Many different configurations for the network are possible but all are subject to the following configuration constraints:

- There can be only one MUXserver 320 in a MUXserver 320 network, but there may be many MUXserver 320s on a single LAN.
- The maximum number of DECmux 300s in a MUXserver 320 network is six.
- The DECmux 300s are connected to the MUXserver 320 via synchronous links either directly or indirectly via daisy-chaining the DECmux 300s.
- A maximum of three DECmux 300s can be daisy-chained together.
- The MUXserver 320 Network must be a linear network - it must not contain circular synchronous link paths. As a result, there is only one synchronous link path between any DECmux 300 and the MUXserver 320 and between any two DECmux 300s.
- Synchronous links must not have a propagation delay of more than 100mS.
- Because they introduce excessive delays which adversely affect network performance, satellite links on synchronous links are not supported.

**Figure 1-1: MUXserver 320 Network Configuration Principles**



### 1.3 The MUXserver 320

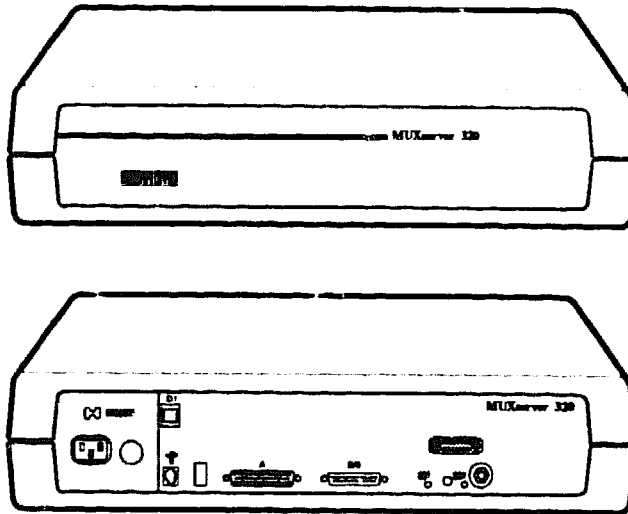
The MUXserver 320 is shown in Figure 1-2.

The MUXserver 320 may be installed in a variety of environments, including offices, computer rooms and satellite equipment rooms. The MUXserver 320 can be placed on a desk or table, or can be mounted in a standard rack cabinet. Digital Equipment Corporation can supply a wall/partition mounting bracket to mount the unit directly onto an office wall or to suspend it from partitioned office walls. This bracket must be ordered separately. See Appendix B for ordering information.

All controls, indicators and connectors used to install and operate the MUXserver 320 are located on the rear panel of the unit, as shown in Figure 1-3.

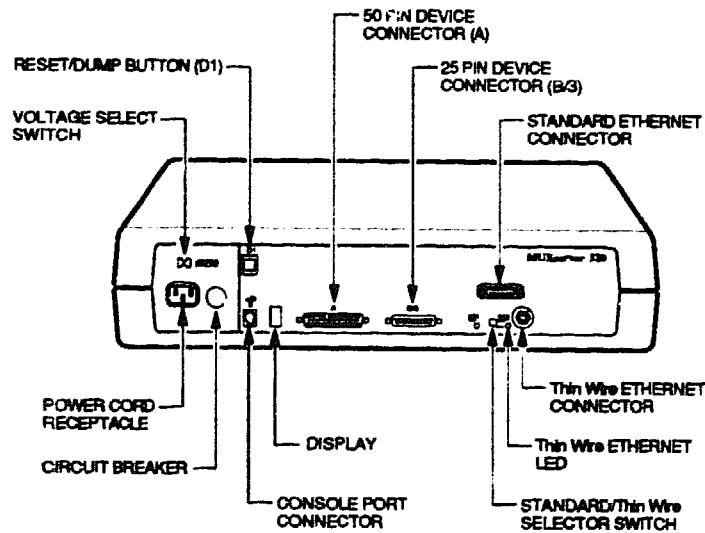


**Figure 1-2: MUXserver 320 Model DSRZE-XX**



SN-116-01

**Figure 1-3: MUXserver 320 Controls, Indicators and Connectors**



SN-008-01

The unit's controls, indicators and connectors are described briefly in Tables 1-1, 1-2 and 1-3 respectively. Additional information on the connectors and the associated cables is contained in Chapter 5.

**Table 1-1: MUXserver 320 Controls**

| <b>Control</b>                             | <b>Description</b>   |
|--|--|
| Reset button (D1)                          | Applying power while this button is pressed loads the unit's default parameters.<br>Pressing this button while the MUXserver 320 is running causes the unit to upline dump its memory contents - if DUMP is enabled. |
| Voltage select switch                      | This switch sets the input voltage to the range required (100-120Vac or 220-240Vac).   |
| Circuit breaker                            | This press-to-reset circuit breaker protects the unit from damage caused by excess supply current.   |
| Standard/ThinWire Ethernet selector switch | This switch selects either ThinWire or Standard Ethernet.<br><b>Warning:</b> Operating this switch, when the MUXserver 320 software is running, will have unpredictable results.                                     |

**Table 1-2: MUXserver 320 Indicators**

| <b>Indicator</b>      | <b>Description</b>  |
|-----------------------|---|
| ThinWire Ethernet LED | Indicates that the ThinWire Ethernet connector is selected. |
| Standard Ethernet LED | Indicates that the standard Ethernet connector is selected. |
| 7-Segment Display     | Displays error and status information.                      |

**Table 1-3: MUXserver 320 Connectors**

| <b>Connector</b>            | <b>Description</b>  |
|-----------------------------|---|
| 25-pin device connector     | This 25-pin male D-type connector connects an EIA-232-D/V.24/V.28 device to the MUXserver 320.  |
| 50-pin device connector     | This 50-pin male D-type connector connects a device to the MUXserver 320. The device must support one of the following standards: <ul style="list-style-type: none"> <li>• EIA-232-D/V.24/V.28</li> <li>• RS-449/RS-423-A</li> <li>• RS-449/RS-422-A/V.36</li> <li>• V.35</li> <li>• Null-modem/RS-422</li> <li>• X.21 data leads only</li> </ul> The device connects via an adaptor cable. |
| Standard Ethernet connector | This 15-pin female D-type connector connects to a standard Ethernet local area network using transceiver cable.   |
| ThinWire Ethernet connector | This female BNC connector connects to a ThinWire Ethernet local area network using ThinWire cable and a T-connector.  |

**Table 1-3 (Cont.): MUXserver 320 Connectors**

| Connector              | Description   |
|------------------------|---|
| Power cable receptacle | The MUXserver 320's power cable plugs into this receptacle.   |
| Console connector      | This 6-pin Modified Modular Jack (MMJ) connects a console to the MUXserver 320's Supervisor Port for installation, configuration, or troubleshooting. |

## 1.4 Connecting the MUXserver 320

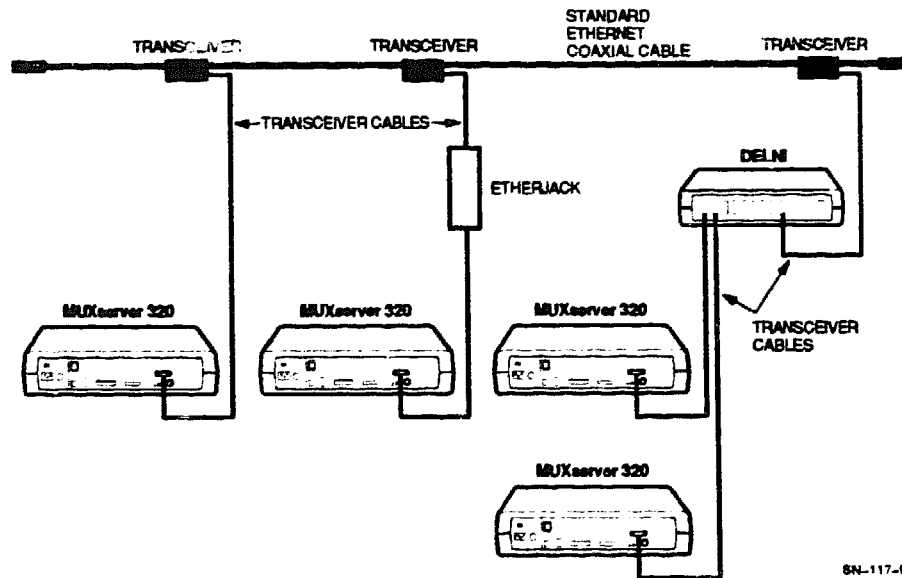
Connections can be made to the MUXserver 320 as follows:

- **Ethernet Port**

A transceiver cable connects the MUXserver 320 to the Ethernet network via the Ethernet port (see Figures 1-4 and 1-5). The transceiver cable can be connected to:

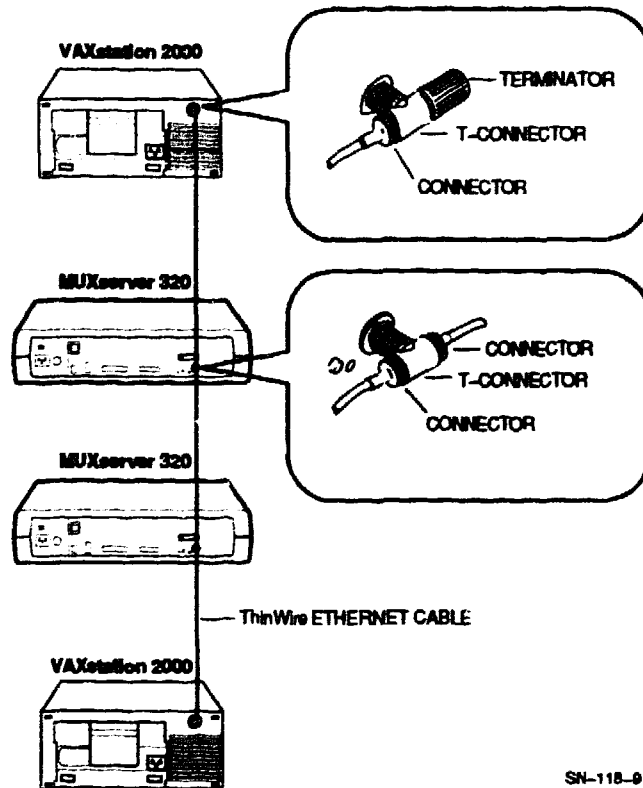
- \* Another transceiver cable section,
- \* A DELNI Local Network Interconnect,
- \* A transceiver on a standard Ethernet coaxial cable for Digital baseband networks, or
- \* A ThinWire Ethernet Station adaptor (DESTA) on a ThinWire Ethernet coaxial cable (see Figure 1-5).

**Figure 1-4: Standard Ethernet Coaxial Cable Connection**



SN-117-91

**Figure 1-5: ThinWire Ethernet Coaxial Cable Connection**



SN-118-01

- **Synchronous Links**

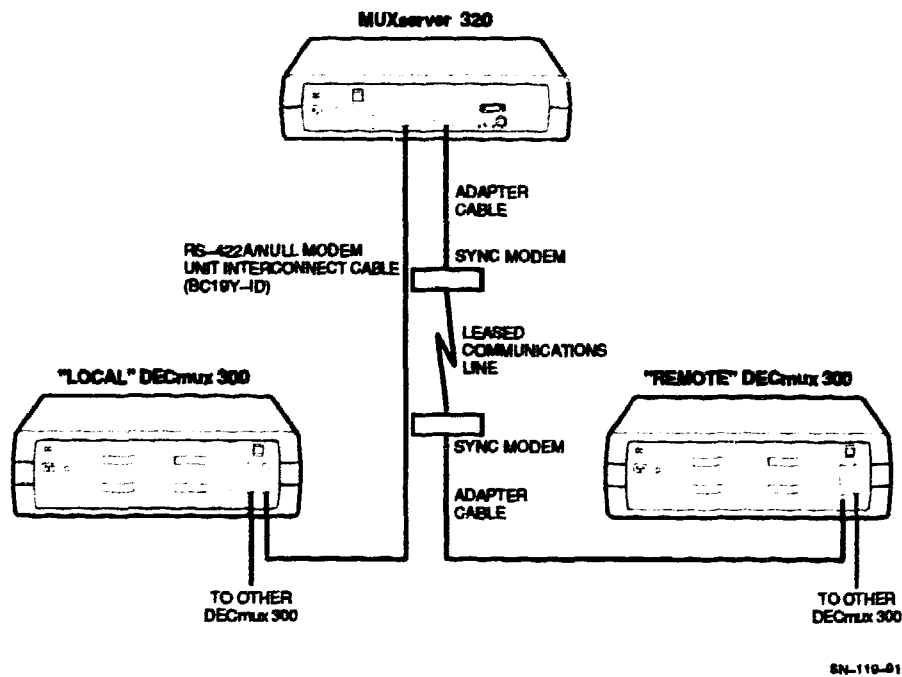
A synchronous link on the MUXserver 320 network typically includes the following components (see Figure 1-6):

- \* An adaptor cable which connects the synchronous port to a synchronous modem. The correct adaptor cable must be used to select the appropriate interface standards for connection to the modem. The adaptor cables are 60cm (2ft) long and are designed to be used with the corresponding extension cables. Such cabling is required at both ends of the synchronous link. Refer to Appendix B for ordering information.
- \* A synchronous modem for interfacing between the adaptor cable and the leased communications line. Modems are required at each end of the communications line.

Link speeds supported by the network depend on the interface selected. Table 1-4 shows the link speeds supported for the various interfaces.

Local synchronous link connection is also possible by using a RS-422-A/Null Modem unit interconnect cable (BC19Y-10). This cable directly connects two synchronous links and no leased communications line is required (see Figure 1-6). If a connection longer than 3m (10ft) provided by the BC19Y-10 is required, a custom cable will have to be made.

**Figure 1-6: Synchronous Link Connections**



**Table 1-4: Synchronous Link Speeds**

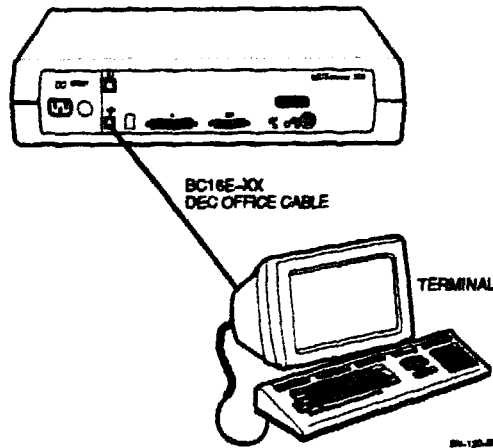
| Interface            | Speeds (Kbps)                            |                              |
|----------------------|--|------------------------------|
|                      | Link A                                   | Link B                       |
| V.35                 | 48, 56 and 64                            | Not supported                |
| X.21 data leads only | 2.4, 4.8, 9.6, 14.4, 19.2, 48, 56 and 64 | Not supported                |
| V.24/V.28/EIA-232-D  | 2.4, 4.8, 9.6, 14.4 and 19.2             | 2.4, 4.8, 9.6, 14.4 and 19.2 |
| Null-modem/RS-422    | 2.4, 4.8, 9.6, 14.4, 19.2, 48, 56 and 64 | Not supported                |
| RS-449/RS-423-A      | 2.4, 4.8, 9.6, 14.4, 19.2, 48, 56 and 64 | Not supported                |
| RS-449/RS-422 (V.36) | 2.4, 4.8, 9.6, 14.4, 19.2, 48, 56 and 64 | Not supported                |

- **Supervisor Port**

A DEC OFFICE cable (BC16E) connects an asynchronous terminal to the MUXserver 320 (see Figure 1-7). An appropriate adaptor may also be required if the terminal uses conventional D-type EIA-232-D interface connectors. Refer to Appendix B for additional information.

The maximum cable lengths are detailed in Section 4.4. Ensure that the specified maximum cables lengths are not exceeded.

**Figure 1-7: Supervisor Port Connection**



## 1.5 Installation Overview

Installing the MUXserver 320 involves the following activities which are described in this manual:

- Determining the installation location and mounting method, and preparing the site,
- Installing the MUXserver 320 hardware,
- Verifying the MUXserver 320's operation, and
- Connecting the MUXserver 320 to the network.

Installing the MUXserver 320 Software on the load hosts, and subsequent MUXserver 320 software installation and network verification are described, as appropriate in:

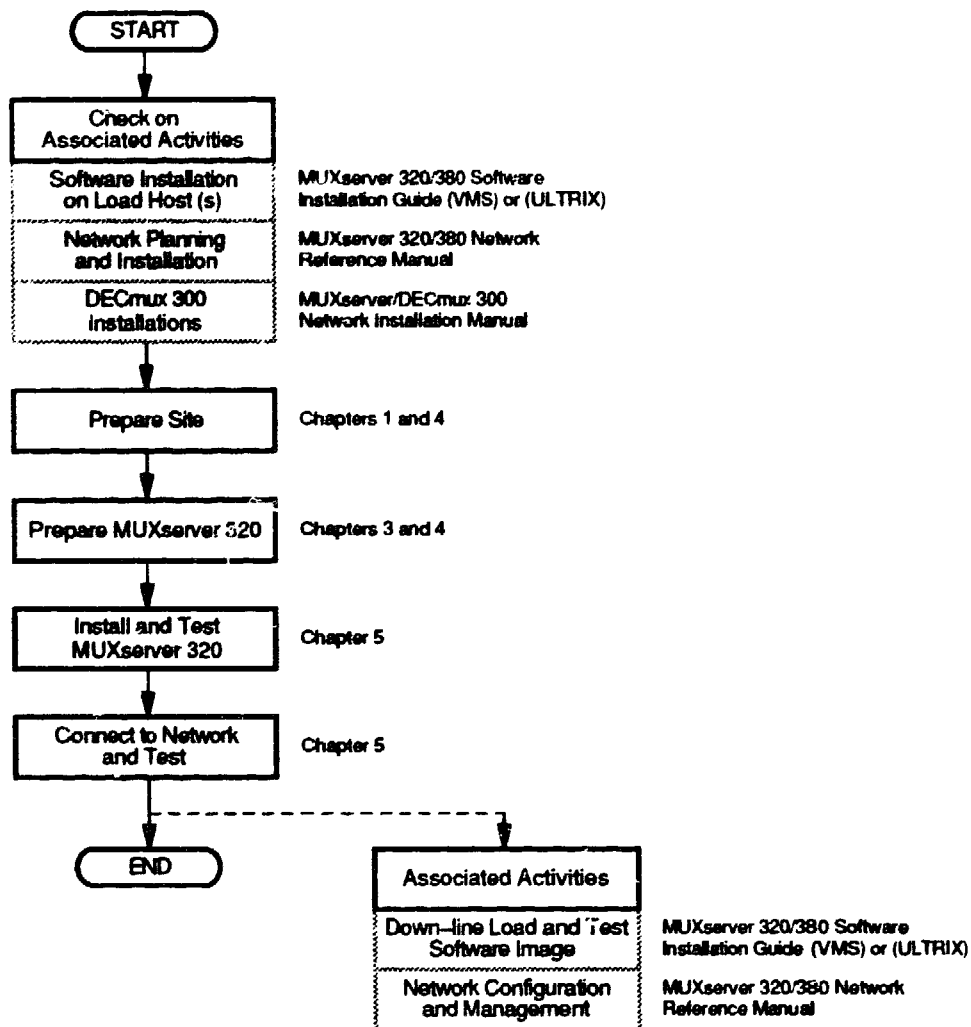
- *The MUXserver 320/380 Software Installation Guide (VMS)*, and
- *The MUXserver 320/380 Software Installation Guide (ULTRIX)*.

Initial network configuration and ongoing network management are described in the *MUXserver 320/380 Network Reference Manual*.

Figure 1-8 shows the major MUXserver 320 installation activities and their sequence.

For the more experienced installer, Chapter 2 contains a summary of the MUXserver 320 hardware installation activities with reference to particular sections, should further information be required.

**Figure 1-8: MUXserver 320 Installation Activities**



SN-121-91

## 1.6 Items Required for MUXserver 320 Installation

The following items may be required for a MUXserver 320 installation:

- MUXserver 320 Remote Terminal Server, order code DSRZE-Ax, which contains:
  - \* MUXserver 320,
  - \* BNC T-connector, order code H8233-A,
  - \* Two BNC 50 ohm terminators, order code H8255-A,
  - \* 25 pin synchronous link loopback connector, order code H3266-00,
  - \* 50 pin synchronous link loopback connector, order code H3199,

- \* **Rack Mounting Kit**, order code H041-AA
  - \* *MUXserver 320 Hardware Installation Manual* (this document),
  - \* *MUXserver 320/380 Network Identification Card*,
  - \* **MUXserver 320 Software License**, and
  - \* **Power Cable** (supplied with DSRZE-AA only).
- **Country Kit**, which contains a power cable suitable for the appropriate country (not required for DSRZE-AA). Refer to Appendix B.
  - **Wall mounting kit**, order code H039.
  - **Transceiver Cable**, BNE3x-xx or BNE4x-xx, for Ethernet connection.
  - **Adaptor Cable and Extension Cable**, for each synchronous link to be connected. Refer to Appendix B.
  - **DEC OFFICE Cable**, BC16E-xx, with the appropriate adaptor (H8571-x), if necessary, for supervisor port connection.
  - If not already installed at the site, either:
    - \* **For a Standard Ethernet**: Transceiver, order code H4000 or equivalent.
    - \* **For a ThinWire Ethernet**:
      - BNC T-connector, order code H8223-A, and
      - ThinWire Ethernet Station adaptor (DESTA), order code 70-22782-01.
  - **MUXserver 320 distribution software for VMS or ULTRIX**, see Appendix B.
- The distribution software includes a downline loadable image of the MUXserver 320 operational software. This must be installed on at least one load host.
- The following additional software products may be required to be installed on each load host:
- \* For VMS load hosts, DECnet Phase IV or later, or
  - \* For ULTRIX load hosts, Maintenance Operation Protocol (MOP).

Appendix B lists the available MUXserver 320 accessories.

## 1.7 Service Options

This section describes the Digital Equipment Corporation hardware and software options that are available for the MUXserver 320 network.

For additional information, or to arrange return of a faulty MUXserver 320 for repair or replacement, contact your Digital Services representative. Pack the unit correctly using its original shipping carton and packaging material.



### **1.7.1 Digital On-Site Service**

Digital Equipment Corporation provides on-site service under a service agreement or on a per-call basis. Trained service specialists perform on-site hardware maintenance.

### **1.7.2 Installation Service**

Installation service includes services provided by trained service specialists for successful installation of a MUXserver 320 network.

### **1.7.3 Software Product Service Agreements**

Digital Equipment Corporation offers software product service agreements.

### **1.7.4 Training**

Digital Educational Services provides training on installation, maintenance and management of Digital software. The format varies from seminars to packaged training courses.



## Chapter 2

---

### Quick Installation Guide

This chapter provides a summary of the MUXserver 320 hardware installation activities.

If further information is required on any activity, refer to the nominated sections of this or other manuals as appropriate.

#### 2.1 Associated Preliminary Activities

Installation of the MUXserver 320 hardware requires the following activities to have been completed:

- |  |  |
|--|--|
| 1. Plan and install the associated MUXserver 320 network, including installation and testing of inter-site synchronous links and synchronous modems. | <i>MUXserver 320/380 Network Reference Manual</i>  |
| 2. Obtain all equipment and material required for installation.  | Section 1.6  |
| 3. Install the MUXserver 320 software on the load host(s).   | <i>MUXserver 320/380 Software Installation Guide (VMS) or MUXserver 320/380 Software Installation Guide (ULTRIX)</i> |
| 4. Install and test all DECmux 300s.   | <i>MUXserver/DECmux 300 Network Installation Manual</i>  |

#### 2.2 Preparing the MUXserver 320

- |  |                     |
|--|---------------------|
| 1. Unpack cartons and check their contents.  | Sections 3.1 to 3.3 |
| 2. Verify the Voltage Select switch setting. | Section 3.4.1       |

## 2.3 Site Preparation

1. Ensure that ventilation is adequate and environmental conditions are correct. Section 4.2
2. Ensure that the mains power supply is correct. Section 4.3
3. Ensure that correct cables are available. Section 4.4
4. Ensure that maximum cable lengths are not exceeded. Table 4-4

## 2.4 Hardware installation

1. **Desk Top Mounting** Section 5.2.1
2. **Wall Mounting:** Section 5.2.2  
Attach the mounting plate to the wall.  
Attach the MUXserver 320 to the mounting plate.
3. **Rack Mounting:** Section 5.2.3  
Remove the MUXserver 320's protective cover.  
Attach mounting brackets to the MUXserver 320.  
Attach the MUXserver 320 to the equipment rack.

## 2.5 Testing the MUXserver 320 Hardware

1. Select ThinWire Ethernet and connect the BNC T-connector and 50 ohm terminators. Sections 5.3.1 and 5.3.2
2. Run self-test (apply power). Sections 5.3.3 and 5.3.4
3. Disconnect power.

## 2.6 Connecting the MUXserver 320 to the Network

1. Connect the MUXserver 320 to either the ThinWire or Standard Ethernet. Section 5.4
2. Connect a terminal to the console port. Section 5.5
3. Either:  
Connect a synchronous modem to the 50-pin synchronous link (Link A), or Section 5.6.1  
Connect a co-located DECmux 300 to the 50-pin synchronous link (Link A). Section 5.6.2
4. Connect synchronous modem to the 25-pin synchronous link (Link B). Section 5.6.3

## 2.7 Completing the Installation

- |  |             |
|--|-------------|
| 1. Conduct final checks.   | Section 5.7 |
| 2. Start the MUXserver 320 (apply power).                              | Section 5.7 |
| 3. Observe self-test results.  | Section 5.8 |
| 4. Complete the <i>MUXserver 320/380 Network Identification Card</i> . | Section 5.9 |

## 2.8 Installation Difficulties

For assistance with installation difficulties, refer to Chapter 6.

## 2.9 Associated Subsequent Activities

For information, activities which follow installation of a MUXserver 320 (described above) include:

- |  |   |
|--|---|
| 1. Down-loading and testing the MUXserver 320 software image | <i>MUXserver 320/380 Software Installation Guide (VMS)</i> or <i>MUXserver 320/380 Software Installation Guide (ULTRIX)</i> . |
| 2. Ongoing network configuration and management activities   | <i>MUXserver 320/380 Network Reference Manual</i> .   |



## Chapter 3

---

# Preparing the MUXserver 320

### 3.1 Unpacking the MUXserver 320

Unpack the MUXserver 320 carton and check its contents for:

- One MUXserver 320, complete with plastic enclosure.
- One or more accessory cartons (see Section 3.2).
- One Ethernet loopback connector.
- One H3199 synchronous link loopback connector.
- One H041-AA rack mounting kit.
- One US/CANADA power cable (included with only the DSRZE-AA option).

For other options, the power cable is included in the relevant Country Kit (see Section 3.3).

- One *MUXserver 320 Hardware Installation Manual*,
- One *MUXserver 320/380 Network Identification Card*, and
- One MUXserver 320 Software License

If any contents are missing or damaged, stop unpacking and contact your Digital Equipment Corporation sales representative.

Retain the carton and all packaging material in case any item needs to be returned to Digital Equipment Corporation.

### 3.2 Unpacking the Accessories

The number of accessory carton(s) and their contents depends on the MUXserver 320 options ordered. Open the accessories carton(s) and check the contents against the ordered items listed in the bill of materials.

If any items are missing or damaged, stop unpacking and contact your Digital sales representative.

Retain the carton(s) and all packaging material in case any item needs to be returned to Digital Equipment Corporation

### 3.3 Unpacking the Country Kit

One country kit is required for each MUXserver 320. As an exception, with MUXserver 320 option AA (North America), the power cable is included with the MUXserver 320 and a country kit is not required.

Unpack the country kit and check that it contains a suitable power cable.

### 3.4 Pre-Installation Checks

#### 3.4.1 Verifying the Voltage Select Switch Setting

**Caution**

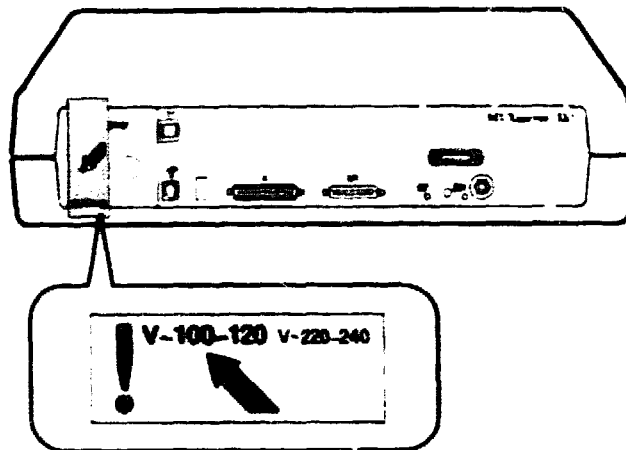
Perform this step with care. An incorrect voltage setting will result in damage to the MUXserver 320.

Peel the voltage label from the MUXserver 320 to expose the voltage select switch.

Check that the voltage select switch is set to the operating range to suit the local supply voltage. Contact an electrician if you are unsure of the local supply voltage.

If the voltage setting is not set correctly, set it to match the local supply voltage.

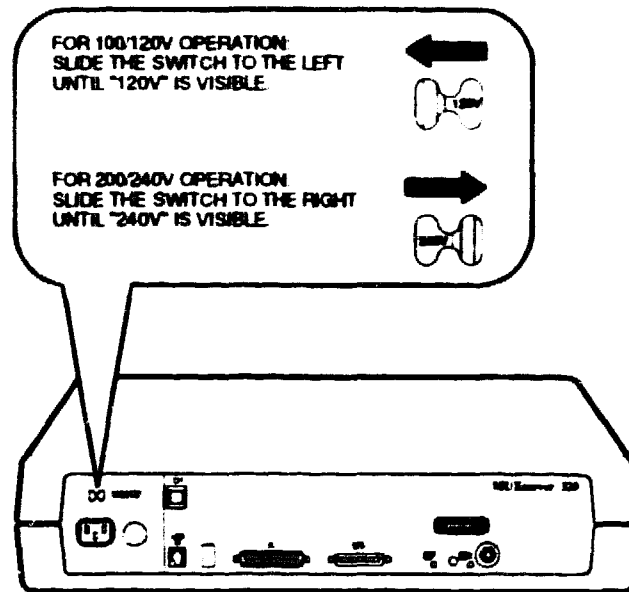
**Figure 3-1: Supply Voltage Label**



94-122-01



**Figure 3-2: Supply Voltage Select Switch**



SN-123-01

### 3.4.2 Site Preparation

Before installing the MUXserver 320, ensure that its site preparation has been completed by checking that:

#### Hardware

1. If the MUXserver 320 is to be connected to a Standard Ethernet:
  - The appropriate baseband or broadband network interface (for example, an Etherjack junction box, DELNI, DESTA or Ethernet transceiver) is installed, and
  - The required transceiver cabling is installed, tested and tagged (see Section 4.4.1).
2. If the MUXserver 320 is to be connected to a ThinWire Ethernet:
  - The ThinWire Ethernet cabling is installed, tested and tagged, and particularly
    - \* If the MUXserver 320 is to be installed at the end of the ThinWire segment, a BNC T-connector and 50 ohm terminator is available, or
    - \* If the MUXserver 320 is not to be installed at the end of the ThinWire segment, a BNC T-connector is available (see Section 4.4.2).
3. If wall mounting is planned, a wall/partition mounting bracket described in Appendix B, is available.
4. If rack mounting is planned, appropriate rack space is available.

5. Synchronous communication lines and the associated modems are installed and ready for connection to the MUXserver 320.
6. Appropriate adaptor cables and extension cables of the correct length are available for connections to the synchronous modems (see Section 4.4.4).
7. The supervisor port device cable, of correct lengths, is available (see Section 4.4.4).
8. The supervisor port terminal (such as the VT100, VT200 or VT300 series) is ready for connection to the MUXserver 320.

#### **Software**

10. The system/network manager has installed, or is about to install, the distribution software on the load host(s)

#### **Operating Environment**

11. The power outlet matches the MUXserver 320's power cable, is within 1.8m (6ft) of the installation site and meets the electrical specifications (see Sections 4.3 and 4.4.3).
12. Sufficient space has been allowed for ventilation of the MUXserver 320 (see Section 4.1).
13. The temperature, altitude and humidity ranges are correct (see Section 4.2).

Chapter 4 provides a detailed description of site verification.



# Chapter 4

---

## Site Verification

This chapter describes the checks required to ensure that the selected installation site meets the MUXserver 320's physical, environmental, electrical and network cabling requirements.

### 4.1 Ventilation

The air vents at each end of the unit require an unobstructed clearance of 15cm (6in). If the unit is wall mounted, it should be at least 45cm (18in) above the floor to reduce exposure to dust from foot traffic.

Check that the selected MUXserver 320 site will provide:

- At least 45 cm (18 in) clearance above the floor if the unit is to be wall mounted, and
- At least 15 cm (6 in) of free airspace around the MUXserver 320's two air vents

Table 4-1 lists the dimensions and weight of the MUXserver 320.

**Table 4-1: Physical Specifications**

---

| <b>Dimension</b> | <b>Measurement</b> |
|------------------|--------------------|
| Width            | 49.3 cm (19.4 in)  |
| Height           | 11.5 cm (4.5 in)   |
| Depth            | 31.2 cm (12.3 in)  |
| Weight           | 4.6 kg (10.1 lbs)  |

---

### 4.2 Environmental Conditions

Check that the environmental conditions at the planned site are within the ranges listed in Table 4-2

**Table 4-2: Environmental Specifications**

| Parameter                                 | Minimum       | Maximum            |
|---|---------------|--------------------|
| <b>Temperature</b>                        |               |                    |
| Operating                                 | 5°C (41°F)    | 50°C (122°F)       |
| Non-operating                             | -40°C (-40°F) | 66°C (151°F)       |
| Temperature change                        | n.a.          | 20°C/hr (36°F/hr)  |
| <b>Altitude</b>                           |               |                    |
| Operating                                 | n.a.          | 2,438 m (8,000ft)  |
| Non-operating                             | n.a.          | 4,876 m (16,000ft) |
| <b>Relative humidity (Non-condensing)</b> |               |                    |
| Operating                                 | 10%           | 95%                |
| Non-operating                             | 10%           | 95%                |

If the MUXserver 320 is to be operated at an altitude greater than 2,400m, decrease the operating temperature specification by 1.85°C for each 1,000 metres above 2,400m (1°F for each 1,000ft above 8,000ft)

### 4.3 Power Supply

(Check that the power supply at the electrical outlet meets the requirements listed in Table 4-3)

**Table 4-3: Electrical Specifications**

|                       | DSRZE-AA and DSRZE-BA                   | DSRZE-AB and DSRZE-BB                   |
|-----------------------|---|---|
| Supply Voltage        | 88 to 132Vac RMS<br>3-wire single phase | 176 to 264Vac RMS<br>1N+PE single phase |
| Frequency             | 50/60 Hz                                | 50/60 Hz                                |
| Supply Current        | 0.8A (nominal)                          | 0.45A (nominal)                         |
| Power Consumption     | 59W (maximum)                           | 59W (maximum)                           |
| Earth Leakage Current | 650uA                                   | 950uA                                   |

### 4.4 Cabling Requirements

This section describes checks to ensure that correct cabling has been provided for the MUXserver 320 installation. Additional information on cabling and configuring of local area networks, and using DECconnect system products is provided in the *MUXserver 320/360 Network Reference Manual* and the *DECconnect System Planning and Configuration Guide*.

#### 4.4.1 Standard Ethernet Connection

Check that the length of a type BME3x-xx and BNE4x-xx transceiver cable to be used to connect the MUXserver 320 to a Standard Ethernet does not exceed 50m and 12.5m respectively (see Table 4-4).

#### 4.4.2 ThinWire Ethernet Connection

If a ThinWire Ethernet connection is planned, check that

- The ThinWire cable segment length does not exceed 185 m (606ft) - see Table 4-4.
- Each end of the ThinWire cable segment will be connected to a 50 ohm terminator (unless connected to a DEMPR - which contains an inbuilt 50 ohm termination).
- There will be only one ground connection for each ThinWire cable segment.
- There will be a distance of at least 500mm. (19 in) between T-connectors.
- The number of stations, between terminators, will not exceed 30.
- ThinWire cable segments will not be configured in a loop, and
- ThinWire cable segments will not have any branch segments

#### 4.4.3 Power Cable

Check that the MUXserver 320 will be installed within 1.8m (6ft) from a mains power outlet.

**Table 4-4: Maximum Cable Lengths**

| From          | To                       | Maximum Distance | Cable Type                |
|---------------|--------------------------|------------------|---------------------------|
| MUXserver 320 | Transceiver              | 40m (132ft)      | BNE3x-xx                  |
|               |                          | 5m (16.4ft)      | BNE4x-xx                  |
| MUXserver 320 | DELNI                    | 40m (132ft)      | BNE3x-xx                  |
|               |                          | 5m (16.4ft)      | BNE4x-xx                  |
| MUXserver 320 | Power outlet             | 1.8 m (6ft)      | MUXserver 320 power cable |
| MUXserver 320 | DESPR/DEMPR <sup>1</sup> | 185 m (606ft)    | H8243-A                   |

<sup>1</sup>With no other device in the ThinWire segment

#### 4.4.4 Maximum Serial Communication Distances

Check that the lengths of cables to be used to connect each of the MUXserver 320's synchronous links to either a modem or a co-located DECmux 300 do not exceed the limits listed in Table 4-5.

**Table 4-5: Maximum Serial Communication Distances**

| Line Protocol  | Data Rate            | Cable Length     | Comments  |
|----------------|----------------------|------------------|---|
| EIA-232-D/V.24 | All supported speeds | 15m (50ft)       | The V.24 cable capacitance is assumed to be 50pF/ft.  |
| RS-423-A       | Up to 19.2Kbps       | 400m (1300ft)    | The RS-423-A cable capacitance is assumed to be 15pF/ft.  |
|                | 48Kbps               | 150m (500ft)     |   |
|                | 64Kbps               | 130m (400ft)     |   |
| RS-422-A       | All supported speeds | 1,200m (3,900ft) | The RS-422-A cable is assumed to have a capacitance of 15pF/ft and to be terminated (at the far end) with 100 ohms. |
| V.35           | All supported speeds | 60m (200ft)      | Recommended maximum length only.  |

Note: The total length of synchronous link cables includes extension cables, if used, connected between the MUXserver 320 and the associated modem.

## 4.5 Acoustic Noise Levels

Table 4-6 lists the MUXserver 320's declared acoustic noise levels.

**Table 4-6: Acoustic Noise Levels**

Acoustics - Declared values per ISO 9296 and ISO 7779:

|                | $L_{wAd}$ | $L_{pAm}$ (Bystander Positions) |
|----------------|-----------|---------------------------------|
| Idle/Operating | 4.6 bels  | 331dBA                          |

Schallemissionswerte - Werteangaben nach ISO 9296 und ISO 7779/DIN45635-19:

|                  | Schalleistungspegel<br>$L_{wAd}$ , B(A) | Schalldruckpegel<br>$L_{pAm}$ , dB(A)<br>(Zuschauerpositionen) |
|------------------|---|--|
| Leerlauf/Betrieb | 4,6                                     | 31   |





## Chapter 5

---

### Hardware Installation

#### 5.1 Re-check the Voltage Select Switch Setting

Verify the mains voltage select switch settings as described in Section 3.4.1.

#### 5.2 Installation

##### 5.2.1 Desk Top Installation

For desk-top installation, simply place the MUXserver 320 on the desk.

Allow 15 cm (6 in) of airspace around the MUXserver 320's two air vents.

##### 5.2.2 Wall Mounted Installation

A wall/partition mounting bracket kit, available from Digital Equipment Corporation, allows a MUXserver 320 to be attached directly to a wall or suspended from a partitioned office wall. Installation instructions are provided with the kit. Refer to Appendix B for ordering information.

Following the instructions provided with the wall-mounting hardware kit (Order No H039):

- Attach the mounting plate to the wall. Ensure that the MUXserver 320 will have at least 45 cm (18 in) clearance above the floor, and allow 15 cm (6 in) of airspace around the MUXserver 320's air vents.
- Attach the MUXserver 320 to the mounting plate.

##### 5.2.3 Rack Mounted Installation

A rack mounting kit is supplied with each MUXserver 320 or mounting the unit in a standard rack cabinet. When a unit is rack mounted:

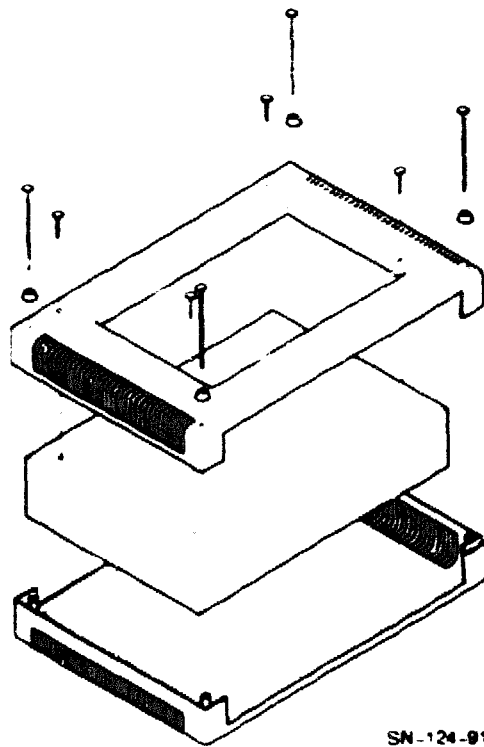
- The unit's protective plastic enclosure is removed.
- No other equipment in the rack or cabinet should obstruct airflow in to or out of the unit.

- Cooling air enters the right end and leaves the left end of the unit (looking at the connector panel). Any other forced ventilation inside the rack/cabinet should not oppose this airflow direction or cause heated air to enter the unit.

To mount the MUXserver 320 in a standard 19 inch customer-supplied rack using the rack mounting hardware kit supplied with the MUXserver 320

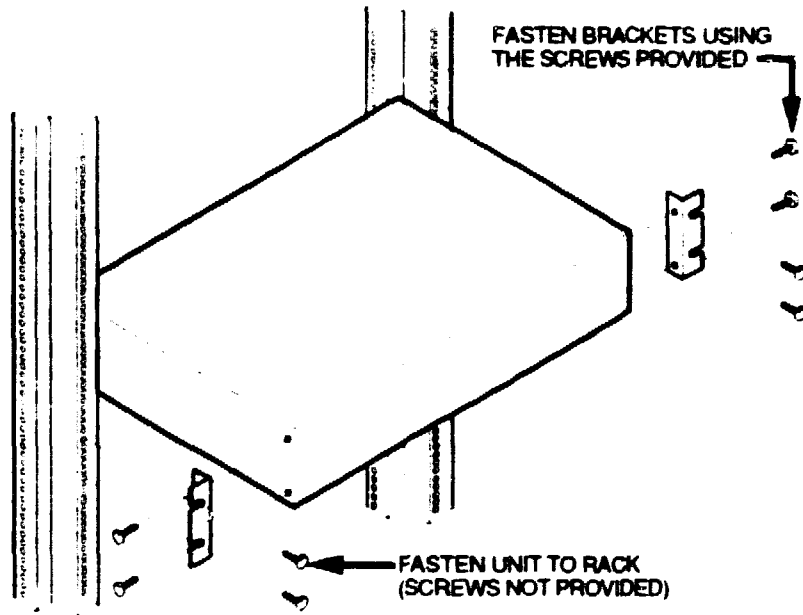
- Using a Phillips screwdriver, unscrew the eight screws from the bottom of the MUXserver 320
- Remove the covers as shown in Figure 5-1  
**Do not re-insert the cover screws.**
- Attach the mounting brackets to the MUXserver 320 using the screws supplied with the kit as shown in Figure 5-2.
- Attach the MUXserver 320 to the rack using the mounting screws, clip-on nuts and brackets supplied with the kit as shown in Figure 5-2.

**Figure 5-1: Removing the Protective Covers**



## 5-2 Hardware Installation

**Figure 5-2: Rack Mounting the MUXserver 320**



### 5.2.4 Satellite Equipment Room

The Satellite Equipment Room is a component of Digital Equipment Corporation's DECconnect System. It provides a central location for communications devices, such as the MUXserver 320, that connect ThinWire Ethernet and twisted-pair cable to a standard Ethernet network.

The Satellite Equipment Room can also be configured as the centre of a stand-alone network and can provide a base from which to expand as network requirements increase. If the MUXserver 320 is being installed in such an environment, or as part of a DECconnect System installation, refer to the *DECconnect System Installation and Verification Guide*.

## 5.3 Testing the MUXserver 320 Hardware

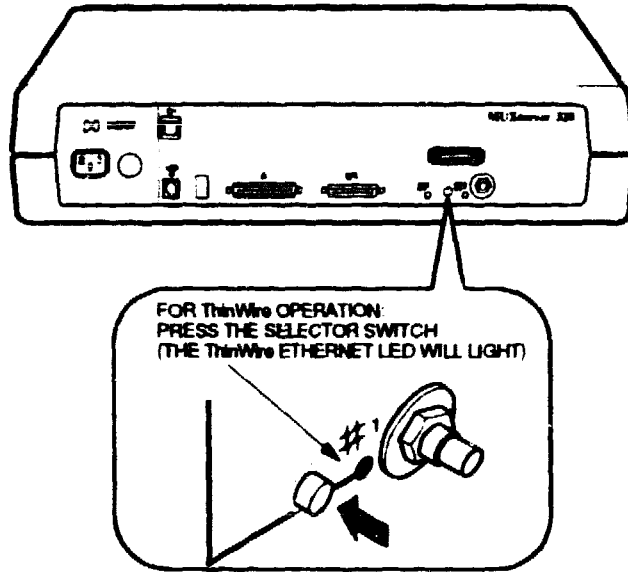
Test the MUXserver 320 hardware before connecting it to the LAN as follows:

1. Select the ThinWire Ethernet (see Section 5.3.1).
2. Connect the BNC T-connector and both 50 ohm terminators to the MUXserver 320 (see Section 5.3.2), and
3. Connect power to the MUXserver 320 (see Section 5.3.3) to run the MUXserver 320's self-test (see Section 5.3.4).

### 5.3.1 Selecting ThinWire Ethernet

If the Ethernet selector switch is not already IN, press it IN to select ThinWire Ethernet. The selector switch will remain in and, when power is applied to the MUXserver 320, the ThinWire Ethernet LED will light (see Figure 5-3).

Figure 5-3: Selecting ThinWire Ethernet



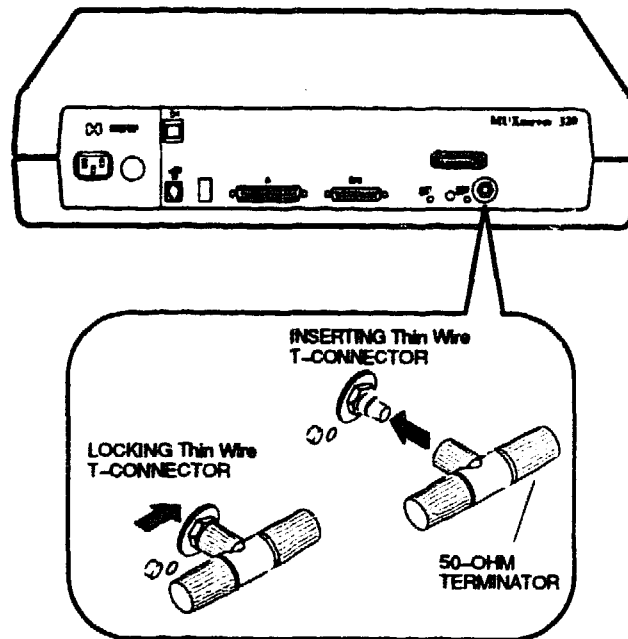
SN-125-01

### 5.3.2 Connecting the ThinWire T-Connector and Terminators

To attach the ThinWire BNC T-connector and two 50 ohm terminators to the MUXserver 320, refer to Figure 5-4 and:

- Attach the two 50 ohm terminators to the BNC T-connector.
- Attach the BNC T-connector to the MUXserver 320's BNC ThinWire Ethernet connector, and
- Turn the barrel of the T-connector clockwise to lock it .

**Figure 5-4: Connecting the ThinWire T-Connector and Terminators**



SV-127-91

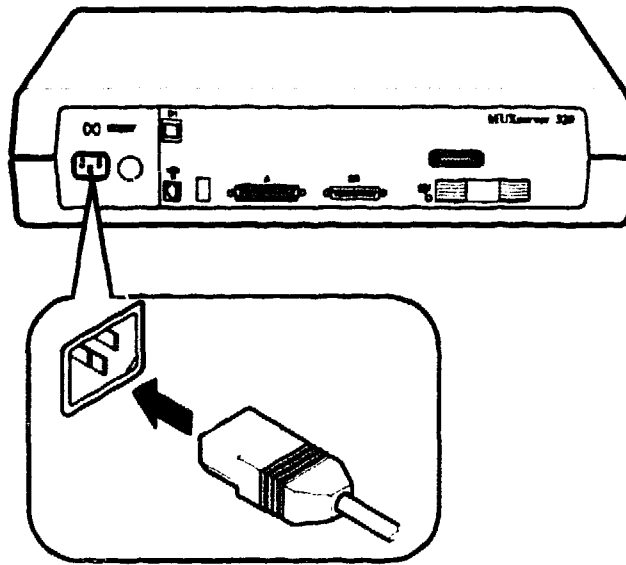
### 5.3.3 Connecting Power to the MUXserver 320

To connect power to the MUXserver 320:

1. Insert the power cable into the power cable receptacle as shown in Figure 5-5, and
2. Insert the power plug into a power outlet and, if necessary, switch the outlet on.

Check that the green Ethernet LED adjacent to the ThinWire Ethernet connector is illuminated. If it is not, refer to Section 6.1.3.

**Figure 5-5: Connecting Power to the MUXserver 320**



SN-128-01

### 5.3.4 Running Self-Test

Applying power to the MUXserver 320 starts the unit's self-test program and, if the LAN is connected, causes the MUXserver 320 software to be loaded from a load host.

During self-test, the MUXserver 320's 7-segment display, which is shown in Figure 5-6, will:

- Display "8" for about five seconds,
- Be blank for about three seconds, and then
- Count down from "F" through "5" (excluding "8") as the unit's internal self-tests are executed. This takes about 80 seconds. Table 5-1 describes the 7-segment display codes and the purpose of the display's decimal point.

If a fatal error is detected during self-test, the count will stop and the 7-segment display will flash the code of the failed test. If a non-fatal error is detected, the count will continue and the 7-segment display's diagnostic dot will blink continuously. Chapter 6 suggests action to be taken in the event of self-test errors.

When the MUXserver 320 passes self-test:

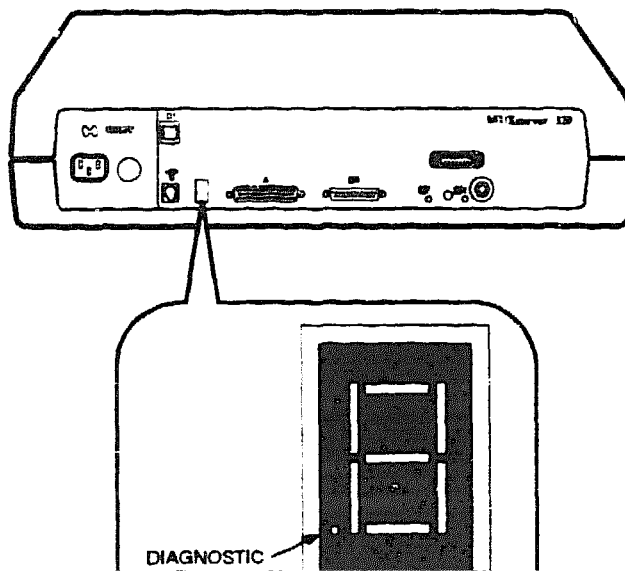
1. The 7-segment display will display "4", indicating that the MUXserver 320 is attempting to load the MUXserver 320 software from the host.
2. The MUXserver 320 will continue attempting to load the software.
3. Because the MUXserver 320 is not yet connected to the network, this attempt to load the software will fail after about two minutes. The MUXserver 320 will then stop attempting to load the software and the 7-segment display will display "3".

4. After a further 20 seconds, the MUXserver 320 will again attempt to load the MUXserver 320 software from the host, with the 7-segment display showing "4", for another two minutes.
5. The MUXserver 320 will continue attempting to load the software in this manner, waiting an increasing time between each 2-minute attempt.

At any time after the 7-segment display shows "3" for the first time:

- Disconnect the MUXserver 320's power cable,
- Disconnect the BNC T-connector and its two terminators from the MUXserver 320's ThinWire Ethernet port
- Continue with the installation by connecting the the MUXserver 320 to the Ethernet as described in Section 5.4

**Figure 5-6: 7-Segment Display**



executed. This takes about 80 seconds. Table 5-1 describes the 7-segment display codes and the purpose of the display's decimal point.

If a fatal error is detected during self-test, the count will stop and the 7-segment display will flash the code of the failed test. If a non-fatal error is detected, the count will continue and the 7-segment display's diagnostic dot will blink continuously. Chapter 6 suggests action to be taken in the event of self-test errors.

When the MUXserver 320 passes self-test:

1. The 7-segment display will display "4", indicating that the MUXserver 320 is attempting to load the MUXserver 320 software from the host.
2. The MUXserver 320 will continue attempting to load the software.
3. Because the MUXserver 320 is not yet connected to the network, this attempt to load the software will fail after about two minutes. The MUXserver 320 will then stop attempting to load the software and the 7-segment display will display "3".

**Table 5-1: 7-Segment Display**

| <b>Display</b>          | <b>System Status</b>  |
|-------------------------|---|
| <b>F</b>                | <b>Bootstrap tests executing</b>                              |
| <b>E</b>                | <b>RAM subsystem test executing</b>                           |
| <b>D</b>                | <b>Interrupt subsystem tests executing</b>                    |
| <b>C</b>                | <b>Timer tests executing</b>                                  |
| <b>B</b>                | <b>ROM subsystem tests executing</b>                          |
| <b>A</b>                | <b>Ethernet subsystem tests executing (internal loopback)</b> |
| <b>9</b>                | <b>Ethernet subsystem external loopback test executing</b>    |
| <b>7</b>                | <b>Async subsystem tests executing (internal loopback)</b>    |
| <b>6</b>                | <b>Async subsystem external loopback test executing</b>       |
| <b>5</b>                | <b>System exerciser tests executing</b>                       |
| <b>4</b>                | <b>Requesting load</b>  |
| <b>3</b>                | <b>Request load backoff</b>                                   |
| <b>2</b>                | <b>Loading</b>  |
| <b>1</b>                | <b>Requesting dump</b>  |
| <b>0</b>                | <b>Dumping</b>  |
| <b>Rotating segment</b> | <b>MUXserver 320 software executing</b>                       |
| <b>Flashing</b>         | <b>Fatal error detected</b>                                   |

| <b>Diagnostic Dot</b> | <b>System Status</b>                        |
|-----------------------|---|
| <b>On</b>             | <b>No errors</b>                            |
| <b>Off</b>            | <b>Fatal error or self-test in progress</b> |
| <b>Blinking</b>       | <b>Nonfatal error detected</b>              |

## 5.4 Connecting to the Ethernet LAN

As appropriate, connect the MUXserver 320 to either;

- The ThinWire Ethernet LAN as described in Section 5.4.1, or
- The Standard Ethernet LAN as described in Section 5.4.2.



## 5.4.1 Connecting to the ThinWire Ethernet LAN

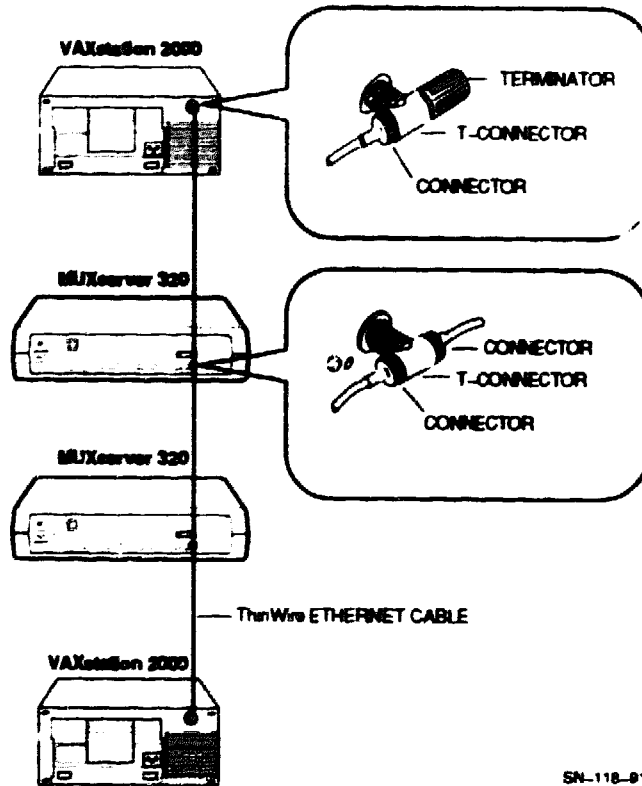
To connect the MUXserver 320 to a ThinWire Ethernet LAN:

1. Check that power has been removed from the MUXserver 320.
2. To select the ThinWire Ethernet, if the Ethernet selector switch is not already IN, press it so that it remains IN.
3. Connect the coaxial cable from the Ethernet to one side of the BNC T-connector. Turn the barrel of the BNC connector clockwise to lock it.
4. Refer to Figure 5-7 and either:
  - If the MUXserver 320 is not at the end of the ThinWire cable segment, that is if there are "further" stations on the ThinWire Ethernet, connect the associated coaxial cable to the other side of the BNC T-connector. Turn the barrel of the BNC connector clockwise to lock it.
  - If the MUXserver 320 is at the end of the ThinWire cable segment, connect the 50 ohm terminator to the other side of the BNC T-connector. Turn the barrel of the terminator clockwise to lock it.
5. Attach the BNC T-connector to the MUXserver 320's BNC ThinWire Ethernet connector. Turn the barrel of the T-connector clockwise to lock it.

Figure 5-7 shows a 50 ohm terminator connected to the BNC T-connector at the end of the cable segment. Note that:

- The terminator is required only if the MUXserver 320 is at the end of a cable segment. Two coaxial cables are attached to the T-connector if the MUXserver 320 is not at the end of a cable segment.
- The cable segment must be terminated by 50 ohm terminators at both ends unless a DEMPR or DESPR (which contain an inbuilt 50 ohm termination) is used. If a cable segment is terminated at one end only with a DEMPR or a DESPR, a terminator must be connected to the other end.

**Figure 5-7: Connecting to the ThinWire Ethernet LAN**



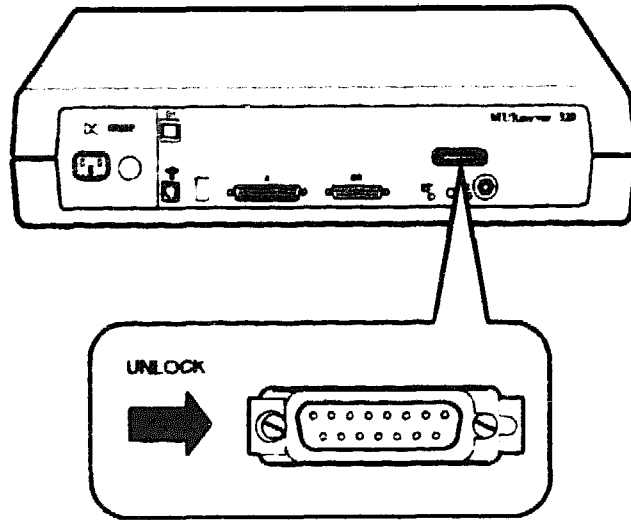
SN-118-81

### 5.4.2 Connecting to The Standard Ethernet LAN

To connect a Standard Ethernet transceiver cable to the MUXserver 320:

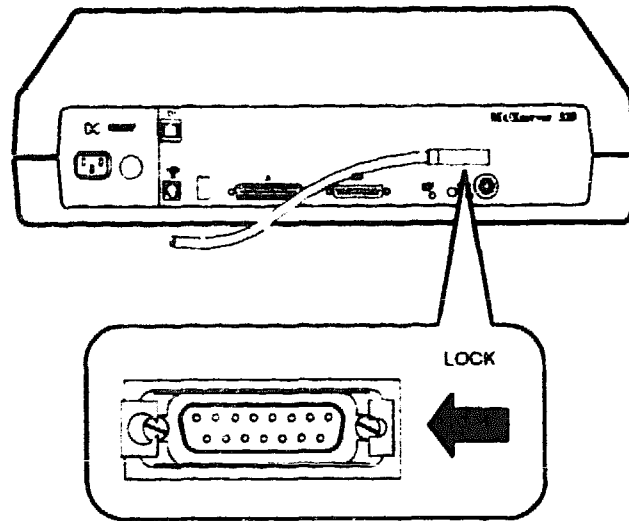
1. Check that power has been removed from the MUXserver 320.
2. To select the Standard Ethernet, if the Ethernet selector switch is not already OUT, press it so that it remains OUT.
3. Unlock the slide latch on the MUXserver 320's Standard Ethernet connector by pushing it in the direction shown in Figure 5-8.
4. Connect the transceiver cable and lock the slide latch on the standard Ethernet connector by pushing it in the direction shown in Figure 5-9.

**Figure 5-8: Unlocking the Slide Latch**



SN-131-01

**Figure 5-9: Connecting the Transceiver Cable**



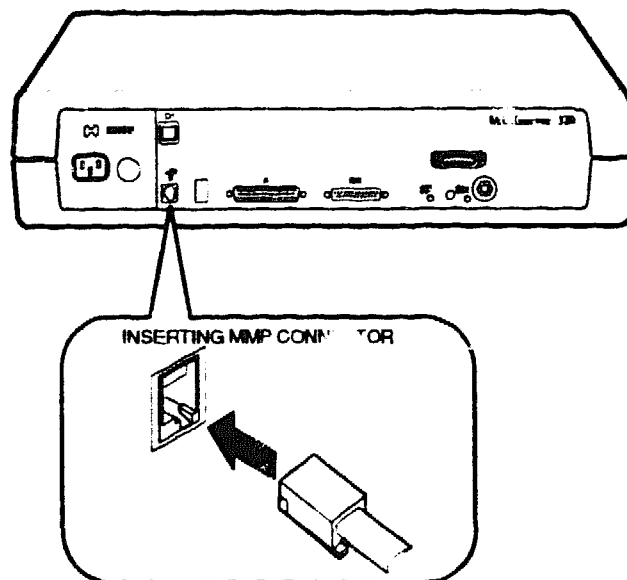
SN-132-01

## 5.5 Connecting a Terminal to the Console Port

To connect a terminal to the Supervisor port connector:

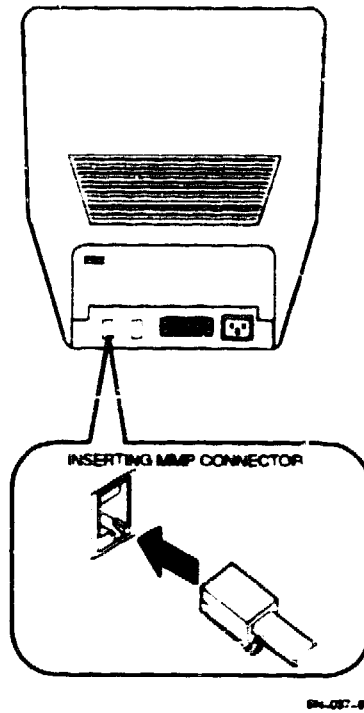
1. Insert the modified modular plug (MMP), on the cable, into a female modified modular jack (MMJ) connector (see Figure 5-10).
2. Insert the modified modular plug (MMP), on the cable, into the female modified modular jack (MMJ) connector on the terminal (see Figure 5-11). If the terminal has a 25-pin, male, D-type connector use an H8571-A adaptor (see Figure 5-12).
3. Power up the terminal.
4. Configure the terminal to operate with:
  - Input and Output Speed = 9,600bps
  - Character Size = 8 bits
  - No Parity Checking
  - One Stop Bit

Figure 5-10: Connecting to the Supervisor Port Connector

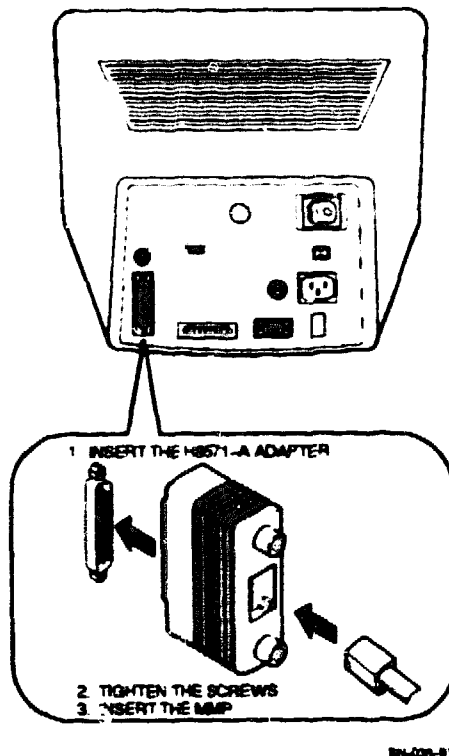


SN-133-01

**Figure 5-11: Connecting to the Terminal**



**Figure 5-12: Connecting to 25-Pin D-type Connector Terminal**



## **5.6 Connecting Synchronous Link Cables**

Up to two synchronous link cables may be connected to the MUXserver 320 to provide connection to up to two DECmux 300s which can include:

- Up to two distant DECmux 300s, via synchronous modems, using:
  - The MUXserver 320's dedicated 50-pin connector (A), or
  - The MUXserver 320's six 25-pin connector (B).
- A DECmux 300 that is co-located with the MUXserver 320, using the MUXserver 320's dedicated 50-pin connector (A).

### **5.6.1 Connecting a Modem to a 50-Pin Connector**

The MUXserver 320's 50-pin connector can be connected to a synchronous modem using the adaptor cables and extension cables listed in Table 5-2.

**Table 5-2: Synchronous Link Adaptor and Extension Cables**

| <b>Interface</b>     | <b>Adaptor Cable</b> | <b>Extension Cable</b> | <b>Interfacing Connector</b> |
|----------------------|----------------------|------------------------|------------------------------|
| V 24/V 28/EIA-232-D  | BS19D-02             | BC22F-xx               | 25-pin male D-type           |
| V 35                 | BC19F-02             | BC19L-xx               | 34-pin male square           |
| RS-449/RS-423-A      | BC19E-02             | BC55D-xx               | 37-pin male D-type           |
| RS-449/RS-422-A      | BC19B-02             | BC55D-xx               | 37-pin male D-type           |
| X 21                 | BC19C-02             | BC22Z                  | 15-pin male D-type           |
| X 21/Data-Leads Only | BC22X-02             | BC22L-xx               | 15-pin male D-type           |

If the 50-pin connector is to be connected to a synchronous modem:

- 1 Connect the 50-pin female D-type connector of the adaptor cable to the 50-pin male D-type connector on the MUXserver 320, as shown in Figure 5-13.
- 2 Connect the extension cable to the adaptor cable, as shown in Figure 5-14.

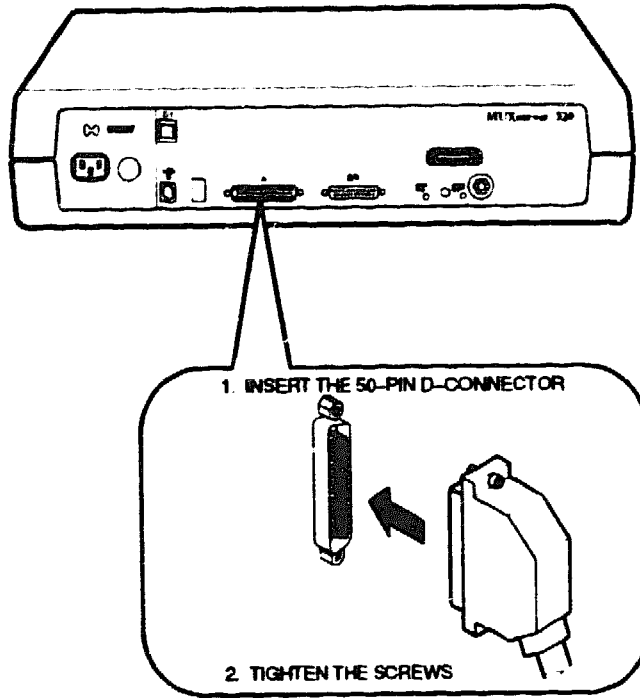
Connect a V24/EIA-232-D adaptor (Order Code 12-27591-01) between the adaptor cable and the extension cable as shown in Figure 5-15 if the synchronous modem implements either:

- A signal with a DCE source on pin 18,
- Signal quality on pin 21, or
- Data Signal Rate Selector (DCE) on pin 23.

If you are unsure of the signals involved, contact Digital Service.

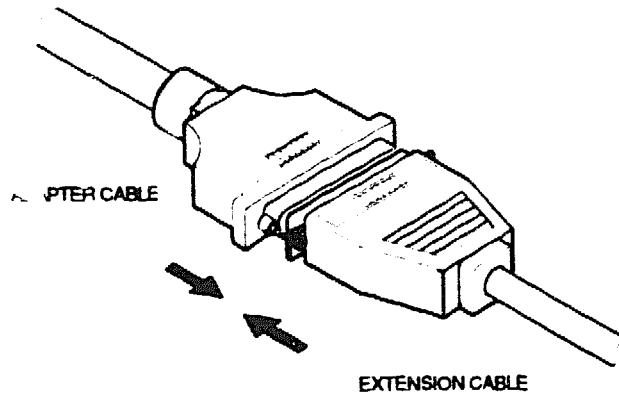
- 3 Connect the extension cable to the modem.

**Figure 5-13: Connecting to the 50-Pin D-Type Connector**



SN-136-01

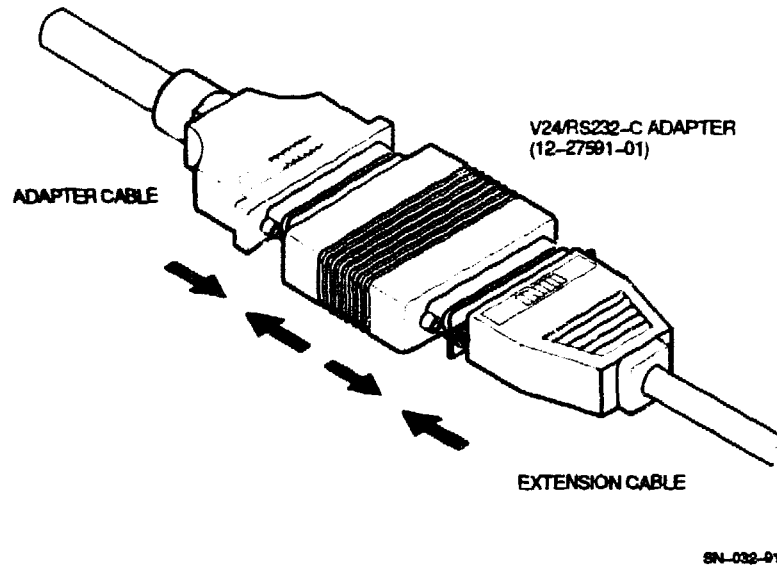
**Figure 5-14: Connecting the Adaptor Cable and Extension Cable**



SN-080-01



**Figure 5-15: Connecting a V24/EIA-232-D Adaptor**



### 5.6.2 Connecting a Co-located DECmux 300

The MUXserver 320's 50-pin connector can be connected to a co-located DECmux 300 using a BC19Y-10 RS-422-A/Null Modem adaptor cable.

If the connector is to be connected to a co-located DECmux 300:

1. Connect one 50-pin female D-type connector of the BC19Y-10 adaptor cable to the 50-pin male D-type connector on the MUXserver 320, as shown in Figure 5-13.
2. Connect the other 50-pin female D-type connector of the BC19Y-10 adaptor cable to the DECmux 300.

### 5.6.3 Connecting a Modem to a 25-Pin Connector

The MUXserver 320's 25-pin connector can be connected to a synchronous modem that is compatible with V.24/V.28/EIA-232-D. The connection is made with a BC22F-xx extension cable.

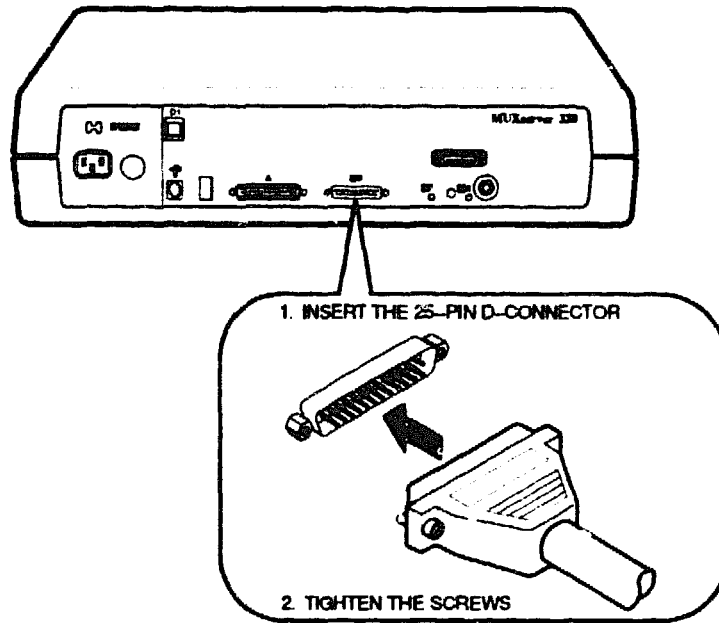
If the 25-pin connector is to be connected to a synchronous modem:

1. Connect the 25-pin female D-type connector of the BC22F-xx extension cable to the adaptor cable, as shown in Figure 5-16.
2. Connect a V24/EIA-232-D adaptor (Order Code 12-27591-01) between the extension cable and the MUXserver 320 as shown in Figure 5-17 if the synchronous modem implements either:
  - A signal with a DCE source on pin 16,
  - Signal quality on pin 21, or
  - Data Signal Rate Selector (DCE) on pin 23.

If you are unsure of the signals involved, contact Digital Service.

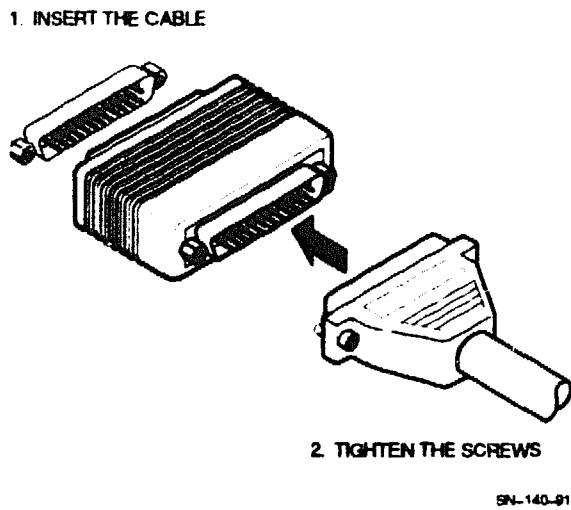
3. Connect the extension cable to the modem.

**Figure 5-16: Connecting a BC22F-xx Extension Cable to the MUXserver 320**



SN-130-91

**Figure 5-17: Connecting the V24/EIA-232-D Adaptor**



## 5.7 Connecting Power

Before connecting power to the MUXserver 320:

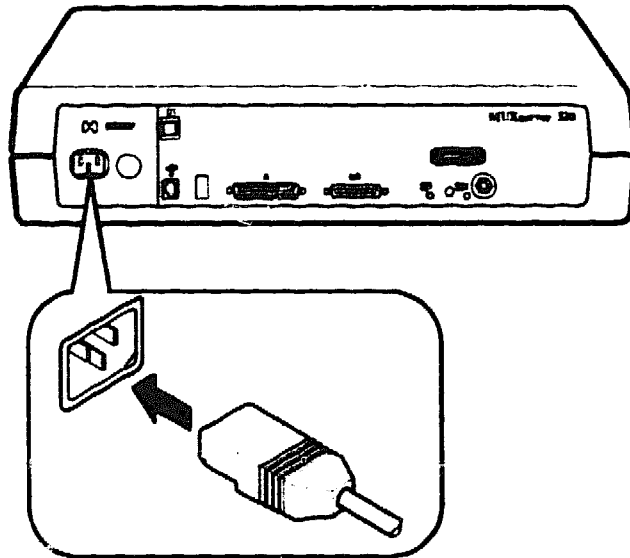
1. Check that the transceiver cables, the console terminal cables and the synchronous link cables are connected correctly and securely.
2. Check that the console terminal has been set up with the correct parameters.
3. Check that the synchronous modem(s) have been switched on and set up with the appropriate operating parameters. In particular, each synchronous modem must be set up to provide both transmit and receive clocks to the MUXserver 320.
4. Check with the system/network manager that the MUXserver 320 software installation and configuration have been completed. For example, check that the distribution software has been installed on the load host(s) and the MUXserver 320 has been configured in the load host database.

To connect power to the MUXserver 320:

1. Insert the power cable into the power cable receptacle as shown in Figure 5-18, and
2. Insert the power plug into a power outlet and, if necessary, switch the outlet on.

Check that one of the green Ethernet LEDs is illuminated. If neither is illuminated, refer to Chapter 6.

**Figure 5-18: Connecting Power to the MUXserver 320**



SN-141-01

## 5.8 Running Self-Test

Applying power to the MUXserver 320 starts the unit's self-tests described in Section 5.3.4. When the unit passes self-test:

1. The 7-segment display will display "4" and then "2", indicating that the MUXserver 320 is loading its software image from the load host.
2. When the software image has been successfully down-line loaded and is executing, the display will show a continuously rotating segment.

## 5.9 Installation Completion

Record the following information in the spaces provided on the *MUXserver 320/380 Network Identification Card* which was included in the MUXserver 320 carton:

- The unit's serial number and Ethernet address (recorded on the back of the unit).
- The location of the MUXserver 320, such as an office location, building number, or floor.
- The Network's DECnet Node Name and DECnet address, if known.
- Your name and the date of installation.

Forward the completed Network Identification Card to the network manager.



## Chapter 6

---

### Installation Difficulties

Problems that may be encountered during MUXserver 320 hardware installation should be investigated, in the first instance, by interpreting:

- Information displayed by the 7-segment display, and
- Error messages displayed on a terminal connected to the Supervisor port.

This chapter describes the various indications which might appear, and suggests appropriate corrective action.

After diagnosing and correcting a problem, continue with the installation described in Chapter 5 - repeating the particular installation step if necessary. If a problem cannot be rectified using the guidelines in this chapter, seek assistance from the system or network manager.

Only hardware-related problems are described in this chapter. For assistance with software-related problems, refer to:

- The *MUXserver 320/380 Software Installation Guide (ULTRIX)* or the *MUXserver 320/380 Software Installation Guide (VMS)*, or
- The *MUXserver 320/380 Network Reference Manual*.

#### 6.1 The 7-Segment Display

The 7-segment display, located on the MUXserver 320's rear panel, indicates the unit's status during its initialization, self-test and operation.

Table 6-1 summarizes the conditions which are indicated on the 7-segment display (a complete list of the 7-segment display codes is contained in Table 5-1). For further information on each type of fault, and for suggested corrective action, refer to the section of this chapter shown in Table 6-1.

**Table 6-1: 7-Segment Display Indications**

| Element                | State            | Indication                                    | Refer to Section |
|------------------------|------------------|---|------------------|
| Diagnostic dot         | On               | Self-test passed                              | -                |
|                        | Off              | Fatal error detected or self-test in progress | 6.1.1            |
|                        | Blinking         | Nonfatal error detected                       | 6.1.2            |
| Alphanumeric character | Off              | No power applied                              | 6.1.3            |
|                        | "3"              | Load request backoff                          | 6.1.4            |
|                        | Flashing         | Fatal error                                   | 6.1.5            |
|                        | Rotating segment | MUXserver 320 software executing              | -                |

### 6.1.1 Diagnostic Dot Off

**Probable Cause:**

There is probably a fault in the MUXserver 320.

**Corrective Action:**

1. Arrange for the MUXserver 320 to be replaced (see Section 1.7), and then
2. Repeat the installation described in this manual.

### 6.1.2 Diagnostic Dot Blinking

The diagnostic dot blinking after power indicates that a nonfatal MUXserver 320 problem has been detected during self-test. To isolate the problem:

- If one is not already connected, connect a terminal to the MUXserver 320's Supervisor port, and
- Refer to Section 6.2 for information on the displayed error message(s).

### 6.1.3 7-Segment Display Off and Green Ethernet LED OFF

**Probable Cause:**

Power is not reaching the MUXserver 320 hardware.

**Corrective Action:**

1. Ensure that the voltage select switch is set correctly.
2. Check that power is available at the power outlet.
3. Secure the power cable at the MUXserver 320 and at the wall outlet and check the fuse in the power cable plug (if applicable).
4. If the MUXserver 320's circuit breaker has tripped, reset it **once only**.

If the circuit breaker trips again:

- Do not reset the circuit breaker again.
- Arrange for the MUXserver 320 to be replaced. (see Section 1.7), and then
- Repeat the installation described in this manual

#### 6.1.4 7-Segment Display Shows "3"

If the 7-segment display shows "3" after power up, the MUXserver 320 might have a down-line loading problem. To isolate the problem:

- If one is not already connected, connect a terminal to the MUXserver 320's Supervisor port, and
- Refer to Sections Section 6.3 to interpret the displayed error message(s)

#### 6.1.5 7-Segment Display Flashing

The 7-segment display flashing indicates that a fatal MUXserver 320 problem has been detected during self-test. Refer to Table 5-1 to determine the likely cause of the problem. The MUXserver 320 will probably need to be replaced (see Section 1.7).

### 6.2 Error Messages

If a terminal has been connected to the Console port connector, it will display MUXserver 320 Console messages.

Sections 6.2.1 to 6.2.6 describe the error messages that might be encountered during self-test and recommended corrective action.

#### 6.2.1 Error Message 1003

```
Init -1003- Enter ^P to repeat self-test or ^B to enter BCP
```

**Probable Cause:**

None of the ports which are enabled to down-line load the MUXserver 320 software have passed self-test.

**Corrective Action:**

The MUXserver 320 displays this error message with error message 1007 (see Section 6.2.2) or error message 1008 (see Section 6.2.3). Refer to these error messages for the correct action.

#### 6.2.2 Error Message 1007

```
Init -1007- Line x, Error detected by self-test
```

**Probable Cause:**

The specified port has failed self-test.



**Corrective Action:**

There is no corrective procedure for this condition. Notify the network manager that the MUXserver 320 must be returned to Digital Equipment Corporation for repair or for replacement (see Section 1.7)

**6.2.3 Error Message 1008**

Init -1008- NI External Loopback error detected by self-test

**Probable Cause:**

The Ethernet port has failed self-test.

**Corrective Action:**

Test the hardware again as shown in Section 5.3. If this fails to correct the problem, notify the network manager that the MUXserver 320 must be returned to Digital Equipment Corporation for repair or for replacement (see Section 1.7).

**6.2.4 Error Message 1010**

Init -1010- Parameter checksum error detected in EEPROM

**Probable Cause:**

Self-test has detected a checksum error in the permanent parameters stored in EEPROM.

**Corrective Action:**

Reset the MUXserver 320 to factory settings (see Table 1-1). If this fails to correct the problem, notify the network manager that the MUXserver 320 must be returned to Digital Equipment Corporation for repair or for replacement (see Section 1.7).

**6.2.5 Error Message 1011**

Init -1011- Console port error detected in executing Self-test

**Probable Cause:**

Self-test has detected an error on the Supervisor port.

**Corrective Action:**

There is no corrective procedure for this condition. Notify the network manager that the MUXserver 320 must be returned to Digital Equipment Corporation for repair or for replacement (see Section 1.7).

## 6.2.6 Error Message 1012

Init -1012- Line x, Modem signal error detected by Self-test

### Probable Cause:

The specified port (line) has failed the modem signal test routine in self-test.

### Corrective Action:

There is no corrective procedure for this condition.

Notify the network manager that the MUXserver 320 must be returned to Digital Equipment Corporation for repair or for replacement (see Section 1.7).

## 6.3 Down-Line Load Problems

If a terminal has been connected to the Console port connector, it will display MUXserver 320 Console messages.

Sections 6.3.1 and 6.3.2 describe the messages that might be encountered during down-line loading.

### 6.3.1 Down-Line Load Starts, Then Falls

The following sequences of messages are displayed on the console terminal at various time intervals:

```
Init -1101- Attempting to locate load host, (ISO8802)
Init -1101- Attempting to locate load host, (ETHERNET)
Init -1100- Requesting load from host xx-xx-xx-xx-xx-xx
Init -1102- Load failure, timeout
```

### Probable Cause:

The load host has failed to complete the down-line load to the MUXserver 320.

### Corrective Action:

Notify the network manager, reporting the error message exactly as it appears on the console terminal.

### 6.3.2 Down-Line Load Does Not Start

The following sequences of messages are displayed on the console terminal at various time intervals:

```
Init -1101- Attempting to locate load host, (ISO8802)
Init -1101- Attempting to locate load host, (ETHERNET)
Init -1103 Router will retry operation in n seconds
```

**Probable Cause:**

The load host(s) not responding to the MUXserver 320's down-line load request within the allotted timeout period.

**Corrective Action:**

Notify the network manager, reporting the error message exactly as it appears on the console terminal.



# Appendix A

## Connector Pin Descriptions

This appendix describes the pins of the MUXserver 320 hardware connectors and the cables used to interface to the MUXserver 320 hardware, including the Ethernet transceiver interface, the device port connectors, and the supervisor port connector.

### A.1 Ethernet Transceiver Interface

The MUXserver 320 has a ThinWire Ethernet connector and a standard Ethernet connector:

- The ThinWire Ethernet connector is a 50 ohm, RG58 type, BNC connector with one pin and a shield.
- The standard Ethernet transceiver interface matches the signal specifications described in *The Ethernet: A Local Area Network: Data Link Layer and Physical Layer Specification*.

Table A-1 lists the signals for the standard Ethernet connector pins.

**Table A-1: Standard Ethernet Transceiver Interface Pin Description**

| Pin | Signal Name           | Pin | Signal Name        |
|-----|-----------------------|-----|--------------------|
| 1   | Shield                | 9   | Collision presence |
| 2   | Collision presence +  | 10  | Transmit           |
| 3   | Transmit +            | 11  | Reserved           |
| 4   | Reserved              | 12  | Receive            |
| 5   | Receive +             | 13  | +12 Volt Power     |
| 6   | +12 Volt Power return | 14  | Reserved           |
| 7   | Reserved              | 15  | Reserved           |
| 8   | Reserved              |     |                    |

## A.2 25-Pin D-Type Connector

Use the 25-pin D-type connector (link B) to connect a device that supports EIA-232-D/V.24/V.28. Table A-2 describes the signals on each pin.

**Table A-2: 25-Pin D-Type Connector Pin Description**

| Pin | Signal Description                         | Signal Name | EIA-232-D | V.24  |
|-----|--|-------------|-----------|-------|
| 2   | Transmitted data                           | TXD         | BA        | 103   |
| 3   | Received data                              | RXD         | BB        | 104   |
| 4   | Request to send                            | RTS         | CA        | 105   |
| 5   | Ready for sending                          | CTS         | CB        | 106   |
| 6   | Data set ready                             | DSR         | CC        | 107   |
| 7   | Signal ground                              | GND         | AB        | 102   |
| 8   | Data channel received line signal detector | CD          | CF        | 109   |
| 12  | Data signal rate selector (DCE)            | SMI         | CI        | 112   |
| 15  | Transmitter signal element timing (DCE)    | TXCLK       | DB        | 114   |
| 17  | Receiver signal element timing (DCE)       | RXCLK       | DD        | 115   |
| 18  | Local Loopback                             | LOC LPBK    | LL        | 141   |
| 20  | Data terminal ready                        | DTR         | CD        | 108/2 |
| 21  | Remote loopback                            | REM LPBK    | RL        | 140   |
| 22  | Ring Indicator                             | RI          | CE        | 125   |
| 23  | Data signal rate selector (DTE)            | DSRS        | CH        | 111   |
| 24  | Transmitter signal element timing (DTE)    | CLK         | DA        | 113   |
| 25  | Test Indicate                              | TEST IND    | TM        | 142   |

## A.3 50-Pin D-Type Connector

Use the 50-pin D-type connector (link A) to connect a device that supports any of the following standards:

- EIA-232-D/V 24/V 28
- RS-449/RS-423-A/V 10
- RS-449/RS-422-A/V 11 (V.36)
- V 35
- X.21 data leads only

Table A-3 describes the signals on each pin.

**Table A-3: 50-Pin D-Type Connector Pin Description**

| Pin | Signal Description                     | Name | EIA-232-D | V.34  | RS-423 | RS-422 | V.35 |
|-----|--|------|-----------|-------|--------|--------|------|
| 1   | Code Gnd                               | **   |           |       |        |        |      |
| 2   | Code 0 *                               | **   |           |       |        |        |      |
| 3   | Code 1 *                               | **   |           |       |        |        |      |
| 4   | Code 2 *                               | **   |           |       |        |        |      |
| 5   | Code 3 *                               | **   |           |       |        |        |      |
| 6   | Transmitted data A                     | **   |           |       |        | SD     |      |
| 7   | Transmitted data B                     | **   |           |       |        | SD     |      |
| 8   | Transmitted data                       | **   | BA        | 103   | SD     |        |      |
| 9   | Request to send A                      | **   |           |       |        | RS     |      |
| 10  | Request to send B                      | **   | BB        | 104   | RD     | RS     |      |
| 11  | Received data A                        | **   | earth     | earth | RD     | RD     |      |
| 12  | Received data B                        | **   | LL        | 141   | LL     | RD     |      |
| 13  | Local Loop                             | **   | CI        | 112   | SI     | LL     |      |
| 14  | Data signal rate selector (DCE)        | **   | TM        | 142   | TM     | SI     |      |
| 15  | Test indicator                         | **   | RL        | 140   | RL     | TM     |      |
| 16  | Remote loopback                        | **   | CE        | 125   | IC     | RL     |      |
| 17  | Ring indicator                         | **   | DD        | 115   | RT     | IC     |      |
| 18  | Receiver signal element timing (DCE) A | **   | earth     | earth | RT     | RT     |      |
| 19  | Receiver signal element timing (DCE) B | **   | DB        | 114   | ST     | RT     |      |

**Table A-3 (Cont.): 50-Pin D-Type Connector Pin Description**

| Pin | Signal Description                           | Name     | EIA-232-D | V.24     | RS-423 | RS-422 | V.35  |
|-----|--|----------|-----------|----------|--------|--------|-------|
| 20  | Transmit signal element timing (DCE) A       | **       | earth     | earth    | ST     | ST     |       |
| 21  | Transmit signal element timing (DCE) B       | **       | DA        | 113      | TT     | ST     |       |
| 22  | Transmit signal element timing (DTE)         | **       |           |          |        |        |       |
| 23  | V35 Transmit signal element timing (DCE) A   | **       |           |          |        |        | 114   |
| 24  | V35 Transmit signal element timing (DCE) B   | **       |           |          |        |        | 114   |
| 25  | V35 Transmit signal element timing (DTE) A   | **       |           |          |        |        | 113   |
| 26  | V35 Transmit signal element timing (DTE) B   | **       |           |          |        |        | 113   |
| 27  | V35 RXD A                                    | **       |           |          |        |        | 104   |
| 28  | V35 RXD B                                    | **       |           |          |        |        | 104   |
| 29  | V35 TXD A                                    | **       |           |          |        |        | 103   |
| 30  | V35 TXD B                                    | **       |           |          |        |        | 103   |
| 31  | V35 Receiver signal element timing (DCE) A   | **       |           |          |        | 115    |       |
| 32  | V35 Receiver signal element timing (DCE) B   | **       |           |          |        | 115    |       |
| 33  | Data terminal ready                          | **       | CD        | 108/2 TR |        | 107    |       |
| 34  | Data set ready A                             | **       | CC        | 107 DM   | DM     | earth  |       |
| 35  | Data set ready B                             | **       | earth     | earth DM | DM     | 105    |       |
| 36  | Ready to send                                | **       | CA        | 105 RS   |        |        |       |
| 37  | Data channel received line signal detector A | DCD A    | CF        | 109      | RR     | RR     | 109   |
| 38  | Data channel received line signal detector B | DCD B    | earth     | earth    | RR     | RR     | earth |
| 39  | Ready for sending A                          | CTS A    | CB        | 106      | CS     | CS     | 106   |
| 40  | Ready for sending B                          | CTS B    | earth     | earth    | CS     | CS     | earth |
| 41  | DCE ground                                   | DCE GND  | earth     | earth    | RC     | RC     | earth |
| 42  | Test transmit data                           | TEST TXD | **        | **       |        |        |       |

**A-4 Connector Pin Descriptions**



**Table A-3 (Cont.): 50-Pin D-Type Connector Pin Description**

| Pin | Signal Description        | Name  | EIA-232-D | V.24 | RS-423 | RS-422 | V.35 |
|-----|---------------------------|---|-----------|------|--------|--------|------|
| 43  | Test RTS                  | TEST RTS  | **        | **   |        |        |      |
| 44  | LTE ground                | DTE GND   | AB        | 102  | SC     | SC     | 102  |
| 45  | Data terminal ready A     | DTR A   |           |      |        | TR     |      |
| 46  | Data terminal ready B     | DTR B   |           |      |        | TR     |      |
| 47  | Terminal Timing A         | CLOCK A   |           |      |        | TT     |      |
| 48  | Terminal Timing B         | CLOCK B   |           |      |        | TT     |      |
| 49  | Test transmit clock       | TEST<br>TXCLK   | **        | **   |        |        |      |
| 50  | Data signal rate selector | DSRS  | CH        | 111  | SR     | SR     |      |
| *   |                           | Code <0:3> identifies the adaptor cable that is attached to the 50-pin connector. |           |      |        |        |      |
| **  |                           | These three pins are used for testing.  |           |      |        |        |      |

## A.4 Supervisor Port Connector

The Supervisor port connector on the MUXserver 320 hardware is a modified modular jack (MMJ). Table A-4 lists the signals on the pins.

**Table A-4: Pin Descriptions for Serial Communication Interface**

| Pin | Signal Description                    |
|-----|---------------------------------------|
| 1   | Tied to VCC via 150 ohm resistor      |
| 2   | Txdata                                |
| 3   | Txcommon                              |
| 4   | Rxcommon                              |
| 5   | Rxdata                                |
| 6   | Tied to ground via 3,000 ohm resistor |



## Appendix B

### Ordering Information

#### B.1 Products in the MUXserver 320 Network

The MUXserver 320 product family consists of two variants of the MUXserver 320 and eight variants of the DECmux 300 which are listed in Table B-1.

**Table B-1: MUXserver 320 Product Family**

| Product No                                    | Major Features                      | Supply Voltage | Country Kit                    |
|---|-------------------------------------|----------------|--------------------------------|
| <b>MUXserver 320 Remote Terminal Server</b>   |                                     |                |                                |
| DSRZE-AA                                      | Standard features                   | 100 to 120Vac  | Not required                   |
| DSRZE-AB                                      | Standard features                   | 200 to 240Vac  | Country Kit ordered separately |
| <b>DECmux 300 Remote Terminal Multiplexer</b> |                                     |                |                                |
| DM308-AA                                      | 8 EIA-232-D ports                   | 100 to 120Vac  | Not required                   |
| DM308-AB                                      | 8 EIA-232-D ports                   | 200 to 240Vac  | Country Kit ordered separately |
| DM316-AA                                      | 16 EIA-232-D ports                  | 100 to 120Vac  | Not required                   |
| DM316-AB                                      | 16 EIA-232-D ports                  | 200 to 240Vac  | Country Kit ordered separately |
| DM316-BA                                      | 16 DEC423 lines<br>2 Type III ports | 100 to 120Vac  | Not required                   |
| DM316-BB                                      | 16 DEC423 lines<br>2 Type III ports | 200 to 240Vac  | Country Kit ordered separately |
| DM332-BA                                      | 32 DEC423 lines<br>4 Type III ports | 100 to 120Vac  | Not required                   |
| DM332-BB                                      | 32 DEC423 lines<br>4 Type III ports | 200 to 240Vac  | Country kit ordered separately |

**Table B-1 (Cont.): MUXserver 320 Product Family**

| <b>Product No</b>              | <b>Major Features</b>        | <b>Supply Voltage</b> | <b>Country Kit</b> |
|--------------------------------|------------------------------|-----------------------|--------------------|
| <b>DECmux 300 Upgrade Kits</b> |                              |                       |                    |
| CK-DM308-A7                    | 8 line EIA-232-D upgrade kit | Not applicable        | Not applicable     |
| CK-DM316-W7                    | 16 line DEC423 upgrade kit   | Not applicable        | Not applicable     |

## B.2 Country Kits

The following country kits contain one power cable suitable for the appropriate country. Note that the DSRZE-AA MUXserver 320 option includes a US/CANADA power cable and does not require a separate country kit

| <b>Description</b> | <b>Order Code</b> |
|--------------------|-------------------|
| Australia          | DM300-KZ          |
| Austria            | DM300-KA          |
| Belgium            | DM300-MA          |
| Denmark            | DM300-KD          |
| Finland            | DM300-MA          |
| France             | DM300-MA          |
| Germany            | DM300-KG          |
| Italy              | DM300-KI          |
| India              | DM300-LJ          |
| Israel             | DM300-KT          |
| Japan              | DM300-KJ          |
| Netherlands        | DM300-MA          |
| New Zealand        | DM300-KZ          |
| Portugal           | DM300-MB          |
| Spain              | DM300-MA          |
| Sweden             | DM300-MA          |
| Switzerland        | DM300-MB          |
| United Kingdom     | DM300-KE          |

## B.3 MUXserver 320 Accessories

The optional wall mounting kit is:

| Description               | Order Code |
|---------------------------|------------|
| Wall mounting bracket kit | H039       |

## B.4 MUXserver 320 Software Distribution Kits

The available MUXserver 320 software distribution kits include:

| Description             | Media         | Order Code  |
|-------------------------|---------------|-------------|
| VMS Distribution Kit    | Magnetic Tape | QA-YWLAA-BM |
| VMS Distribution Kit    | TK50          | QA-YWLAA-H5 |
| ULTRIX Distribution Kit | Magnetic Tape | QA-YWMAA-BM |
| ULTRIX Distribution Kit | TK50          | QA-YWMAA-H5 |

These kits include the MUXserver 320 VMS or ULTRIX software documentation kits listed in Sections B.6.1 and B.6.2, as appropriate.

## B.5 Cables

Interconnecting cables which are suitable for connection to the MUXserver 320 are described in the *Telecommunications and Networks Buyer's Guide*.

## B.6 Documentation

This section provides the information required to order additional documents.

### B.6.1 VMS Software Documentation Kit

The MUXserver 320 VMS documentation kit order code is QA-YWLAA-GZ. The kit contains one of each of:

| Title   | Order Code  |
|---|-------------|
| MUXserver 320/380 Software Installation Guide (VMS) | AA-PESDA-TE |
| MUXserver 320/380 Network Reference Manual          | AA-PESEA-TE |
| MUXserver 300/320/380 User's Reference Card         | AV-PP95A-TE |
| MUXserver 320/380 Software Product Description      | AA-PESGA-TE |
| MUXserver 320/380 System Support Addendum           | AA-PESHA-TE |
| Grey 2" Binder                                      | 99-07705-01 |

## B.6.2 ULTRIX Software Documentation Kit

The MUXserver 320 ULTRIX documentation kit order code is QA-YWMAA-GZ. The kit contains one of each of:

| <b>Title</b>   | <b>Order Code</b> |
|--|-------------------|
| MUXserver 320/380 Software Installation Guide (ULTRIX) | AA-PEUUA-TE       |
| MUXserver 320/380 Network Reference Manual             | AA-PESEA-TE       |
| MUXserver 300/320/380 User's Reference Card            | AV-PP95A-TE       |
| MUXserver 320/380 Software Product Description         | AA-PESGA-TE       |
| MUXserver 320/380 System Support Addendum              | AA-PESHA-TE       |
| Grey 2" Binder   | 99-07705-01       |

## B.6.3 Hardware Documents

The order codes for the hardware manuals are:

| <b>Title</b>                                  | <b>Order Code</b> |
|---|-------------------|
| MUXserver 320 Hardware Installation Manual    | EK-DSRZE-IM       |
| MUXserver 320/380 Network Identification Card | EK-DSRZD-IC       |

## B.7 Ordering Procedures

Refer to the following table for ordering information:

| <b>Your Location</b> | <b>Call</b>   | <b>Contact</b>  |
|----------------------|---------------|---|
| US                   | (800) DIGITAL | Digital Equipment Corporation<br>PO Box CS2008<br>Nashua, New Hampshire 03061   |
| Puerto Rico          | 809-754-7575  | Local Digital subsidiary  |
| Canada               | 800-267-6215  | Digital Equipment of Canada<br>Attn: DECdirect Operations KAO 2/2<br>PO Box 13000<br>100 Herzberg Road<br>Kanata, Ontario K2K 2A6 |
| International        | -             | Local Digital subsidiary or approved distributor  |



## Appendix C

### Instructions For UK Installations

The instructions in this Appendix are intended for use with Digital Equipment Corporation's MUXserver 320 product in the United Kingdom, and meet the requirements of BAPT/SITS /89/43 Section 7.1.

#### C.1 Service Category Specifications

Table C-1 lists the specifications that are relevant to Service Categories 1 and 2.

**Table C-1: Specifications for Service Categories**

| Service Category | Interface (CCITT Recommend) | Specifications |                     | Speed (Kbps) | PTO <sup>1</sup> |      |     |
|------------------|-----------------------------|----------------|---------------------|--------------|------------------|------|-----|
|                  |                             | Physical       | Electrical          |              | BT               | Hull | MCL |
| 1                | X.21bis                     | ISO 2110       | V.24/V.28/EIA-232-D | 2.4          | Yes              | Yes  | Yes |
|                  |                             | BS 6223        | Cable:              | 4.8          | Yes              | Yes  | Yes |
|                  |                             | Part 1 1985    | BC19D-02 (2ft)      | 9.6          | Yes              | Yes  | Yes |
|                  |                             |                | BC22F-10 (10ft)     | 19.2         |                  |      | Yes |
|                  |                             |                | BC22F-25 (25ft)     |              |                  |      |     |
|                  |                             |                | BC22F-35 (35ft)     |              |                  |      |     |
| BC22F-50 (50ft)  |                             |                |                     |              |                  |      |     |
| 2                | X.21bis                     | ISO 2593       | V.35                | 48           | Yes              | Yes  | Yes |
|                  |                             | BS 6223        | Cable:              | 56           | Yes              |      | Yes |
|                  |                             | Part 4 1986    | BC18F-02 (2ft)      | 64           |                  |      | Yes |
|                  |                             |                | BC19L-25 (25ft)     |              |                  |      |     |
|                  |                             |                | BC19L-50 (50ft)     |              |                  |      |     |

<sup>1</sup>BT = British Telecommunications plc; Hull = Kingston Communications (Hull) plc; MCL = Mercury Communications Ltd



## C.2 Direct Connection (BAPT/SITS/89/43 Section 4.2)

The MUXserver 320 product is approved for direct connection to a particular digital circuit, including interconnecting cables with mating connectors conforming to BS 6623 Part 1 and Part 4

## C.3 Apparatus Between MUXserver 320 and Digital Circuit (PTT)

If any other apparatus, including cable or wiring, is to be connected between the MUXserver 320 and the point of connection to any particular digital circuit, then all the other apparatuses shall conform as follows:

1. The overall transmission characteristics of all other apparatuses shall introduce no material effect upon the electrical conditions presented to one another by an apparatus and a digital circuit.
2. All the other apparatus shall comprise only
  - Apparatus approved (such apparatuses may be subject to limitations on their use) for the purpose of connection between the apparatus and a particular digital circuit.
  - Cable or wiring complying with the code of practice for installation of apparatuses covered by the standard or other applicable requirements.

## C.4 Safety Warning for UK Installations

The MUXserver 320 has a label regarding safety requirements of communications modules installed in the United Kingdom. The label states:

***SAFETY WARNING.** See instructions for use . . . . .*

The following warning applies to the United Kingdom

### **Caution**

The port indicated by the safety label is not intended to provide electrical and mechanical isolation, to satisfy the requirements of BS 6301. Connect only apparatus conforming to BS 6301 to the device ports, or apparatus that has previously been evaluated against British Telecom Technical Guides 2 or 26 and given clearance to attach. Other usage will invalidate any approval given to this apparatus.

Connecting apparatuses to which this warning applied, whether the ports are so marked, may produce hazardous conditions on the network. Seek advice from a competent engineer before making any such connection.

Products complying with the Ofel's General Approval NS/G/23/J/1000003 may be connected to the MUXserver 320 and need not carry the BS 6301 warning text or label. **All products supplied by Digital Equipment Corporation comply with the General Approval.**



# GLOSSARY

---

This glossary defines terms used in the *MUXserver 320 Hardware Installation Manual*.

## **Asynchronous**

Pertaining to a communication method in which each event occurs with no relation to a timing signal. See also *Synchronous*.

## **DEC423**

DEC423 is an interface standard developed by Digital Equipment Corporation. It is electrically compatible with EIA Standard EIA-423-A.

## **DECconnect**

A proprietary office networking/communication system. It is based on active networking equipment installed in a *Satellite Equipment Room* connected by radiating cables to wall faceplates in each office. It can include:

- Standard and ThinWire Ethernet connections.
- DEC423 terminal wiring.
- Twisted pair telephone connections, and
- Coaxial cable video connections

## **DELNI**

A local network interconnect product that provides eight separate network interfaces from a single Ethernet transceiver tap.

## **DESTA**

A ThinWire Ethernet transceiver for use with standard Ethernet controllers.

## **EIA**

Electrical Industries Association. A US organization with functions similar to those of CCITT.

**EIA-232-D**

EIA Registered Standard No 232-D

It defines the connectors, cables and electrical characteristics for an asynchronous serial communications interface between a computer and a modem. It is also widely applied to interfaces between computers and other terminal equipment.

**EEPROM**

Electrically-Erasable Programmable Read-Only Memory. This is memory which can be read from and written to but does not lose its information when power is removed.

**EPROM**

Erasable Programmable Read-Only Memory. This is memory which can be easily read from but can only be erased and re-written with special equipment.

**Ethernet**

A Xerox trade mark for a type of local area network based on carrier-sense multiple access /collision detection (CSMA/CD).

**Ethernet Transceiver**

A device which attaches to a standard Ethernet coaxial cable.

**FCC**

Federal Communication Commission.

**IEC**

International Electrotechnical Commission.

**LAN**

Local Area Network.

**LED**

Light Emitting Diode.

**Link**

A communication path between two stations in a MUXserver 320 network which provides statistical multiplexing over a synchronous communication channel.

**MMJ**

Modified Modular Jack.

**MMP**

Modified Modular Plug.

**MODEM**

The word is a contraction of MODulator DEModulator. A modem interfaces a terminal to a transmission line. A modem is sometimes called a dataset.

**Network Manager**

The person responsible for the day-to-day operation of a complete computer network which includes, where appropriate, the MUXserver 320 Remote Terminal Network. This responsibility is often delegated to *System Managers*, *Server Managers* and selected *Privileged Users*.

**Node**

An intelligent device on a network

**Non-privileged User**

An authorized terminal user who has been granted no special access or privileges.

**Port**

An endpoint on the MUXserver 320 network for user communications.

**Privileged User**

An authorized terminal user who has been granted special access or privileges by the *System Manager* or *Network Manager*.

**Repeater**

A device on a network that relays data from one port to another.

**Satellite Equipment Room**

A centralized equipment area which is part of the DECconnect communications system.

**Server**

A hardware and/or software device which provides many users with access to a system.

**Server Manager**

The person responsible for the day-to-day operation of a particular terminal server, including the DECmux 300 Remote Terminal MULTiplexer. Where appropriate, the Server Manager is responsible to the relevant *System Manager* or *Network Manager*.

**Session**

A session occurs when a terminal user is connected to a service node and is provided a specified service. The MUXserver 320 network allows each user to have up to four sessions in effect at once, with one session being active and the others dormant.

**Statistical Multiplexing**

A multiplexing method in which each channel is allocated a variable portion of available transmission time depending on the amount of data it has to transmit. This results in optimum use of the available data transmission rate.

**STATMUX**

*STATistical MULTipleXing.*

**Supervisor Port**

A terminal port which allows the connection of a console terminal. On the MUXserver 320, all system status and error messages are logged on the supervisor port.

**Synchronous**

Pertaining to a communication method in which data bits are synchronized with a timing signal. See also *Asynchronous*.

**System Manager**

The person responsible for the day-to-day operation and control of an individual computer system.

**Terminal**

The generic name for computer peripheral devices that have keyboards and video screens or printers.

**Terminal Server**

An active device, such as a MUXserver 320 network, used to attach to a host system through a network.

**ThinWire**

A Digital Equipment Corporation trade mark used to describe its IEEE 802.3 compliant Ethernet products used for local distribution of data communications.

**ThinWire Ethernet**

An IEEE 802.3 compliant Ethernet network composed of thin Ethernet cable as opposed to standard Ethernet cable.

**ThinWire Segment**

A length of coaxial cable made up of one or more cable sections connected together with BNC barrel connectors and BNC TEE connectors.

**Transceiver**

see *Ethernet Transceiver*.



# Index

---

25-pin connector, 1-5, 5-14, 5-17, A-1  
50-pin connector, 5-14, 5-17, A-3  
25-pin synchronous link, 2-2  
50-pin synchronous link, 2-2  
7-segment display, 1-5, 5-6, 5-7, 5-20, 6-1

## A

---

Adaptor cable, 1-7, 1-11, 3-4, 5-15  
Asynchronous  
  device, 4-3  
  port, 1-1  
  terminal, 1-8

## C

---

Cable, 4-3  
Cable length, 2-2  
Circuit breaker, 1-5, 6-2  
Console  
  connector, 1-6  
  message, 6-3  
  port, 2-2  
  terminal, 1-2, 5-19  
Country kit, 1-11, 3-2, B-1

## D

---

DECconnect, x, 5-3  
DECconnect System Planning and Configuration  
  Guide, 4-2  
DECmux 300, x, 1-1, 1-2, 2-1, 2-2, 4-3, 5-14,  
  5-17, B-1  
DELNI, 1-6, 3-3, 4-3  
DEMPR, 4-3, 5-9  
Desk top mounting, 2-2  
DESPR, 4-3, 5-9  
DESTA, 1-6, 1-11, 3-3  
Diagnostic dot, 5-6  
Dimensions, 4-1

Down-line load, 6-5

## E

---

EIA-232-D, 1-5, 1-8, 4-4, 5-15, 5-17, A-2, A-3  
Environmental, 4-1  
Error message, 6-3  
Ethernet  
  connector, 1-5  
  LED, 1-5, 5-4, 5-5, 5-20  
  loopback connector, 1-10, 3-1  
  selector switch, 1-5, 5-4, 5-9, 5-10  
  transceiver, 3-3, A-1  
Extension cable, 1-11, 5-15

## F

---

Fatal error, 5-8

## L

---

Load host, 5-19, 5-20, 6-5  
  ULTRIX, 1-2  
  VMS, 1-2  
Loopback connector  
  Ethernet, 1-10, 3-1  
  synchronous link, 1-10, 3-1

## M

---

Modem, 1-7, 3-3, 4-3, 5-15

## N

---

Network Identification Card, ix, 1-11, 2-3, 3-1,  
  5-20, B-4  
Network Reference Manual, ix, 1-1, 1-9, 2-1, 2-3,  
  4-2, 6-1, B-3  
Null modem, 1-5, 1-7, 1-8, 5-17



## P

---

Partition mounting, 5-1

### Power

cable, 1-11, 5-5, 5-19, 6-2  
supply 4-2

## R

---

Rack mounting, 2-2, 3-3, 5-1

Rack mounting kit, 3-1

Reset button, 1-5

RS-422-A, 1-5, 1-7, 1-8, A-3

RS-423-A, 1-8, 4-4, 5-15, A-3

RS-449, 1-5, 1-8, 5-15

Run self-test, 2-2

## S

---

Satellite equipment room, 5-3

Satellite link, 1-2

Self-test, 2-3, 5-6, 5-8, 5-20, 6-1, 6-3, 6-5

Software Installation Guide, ix, 1-9, 2-1, 2-3, 6-1,  
B-3, B-4

Software license, 1-11, 3-1

Supervisor port, 1-2, 1-8, 3-4, 5-12, 6-1, 6-4, A-5

Synchronous link, 1-1, 1-2, 1-7, 2-1, 5-14

Synchronous link loopback connector, 1-10, 3-1

Synchronous modem, 1-7, 2-2, 3-4, 5-15

## T

---

Transceiver, 1-6, 4-3

Transceiver cable, 1-11, 4-3, 5-10

## U

---

ULTRIX, B-3

ULTRIX load host, 1-2

## V

---

V.24, 1-5, 1-8, 4-4, 5-15, 5-17, A-2, A-3

V.28, 1-5, 5-15

V.35, 1-5, 1-8, 4-4, 5-15, A-3

V.36, 1-8

VMS, B-3

VMS load host, 1-2

Voltage select switch, 1-5, 2-1, 3-2, 5-1, 6-2

## W

---

Wall mounting, 2-2

bracket, 3-3

kit, 1-11, B-3

## X

---

X.21, 1-8, 5-15

X.21 data leads only, 1-5