

LA100-Series Programmer Reference Manual

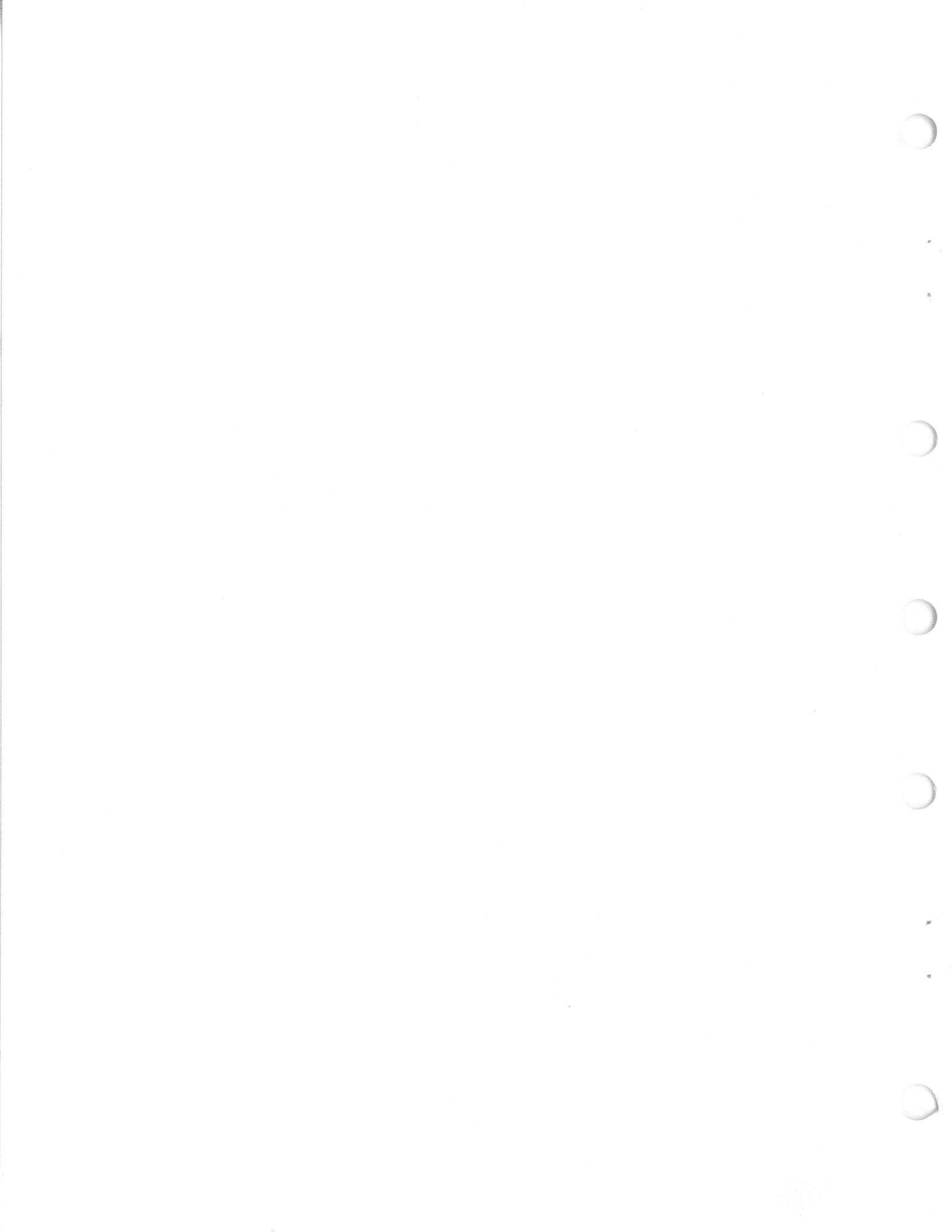

LA100-Series Programmer Reference Manual

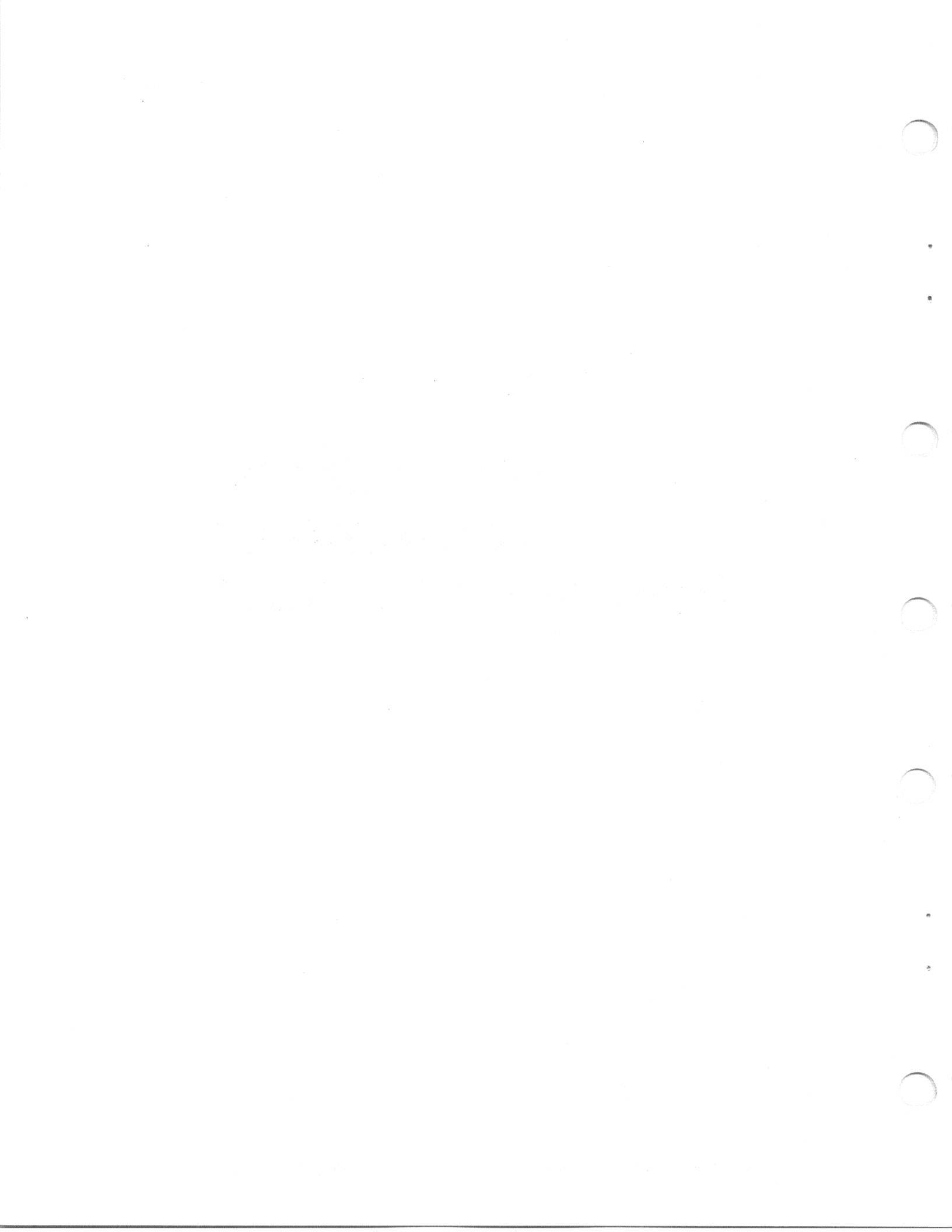

1st Edition, January 1982

Copyright © 1982 by Digital Equipment Corporation

All Rights Reserved

The material in this manual is for informational purposes and is subject to change without notice.

Digital Equipment Corporation assumes no responsibility for any errors that may appear in this manual.

Printed in U.S.A.

The following are trademarks of Digital Equipment Corporation, Maynard, Massachusetts.

DEC	DECnet	IAS
DECUS	DECsystem-10	MASSBUS
Digital Logo	DECsystem-20	PDT
PDP	DECwriter	RSTS
UNIBUS	DIBOL	RSX
VAX	EduSystem	VMS
		VT

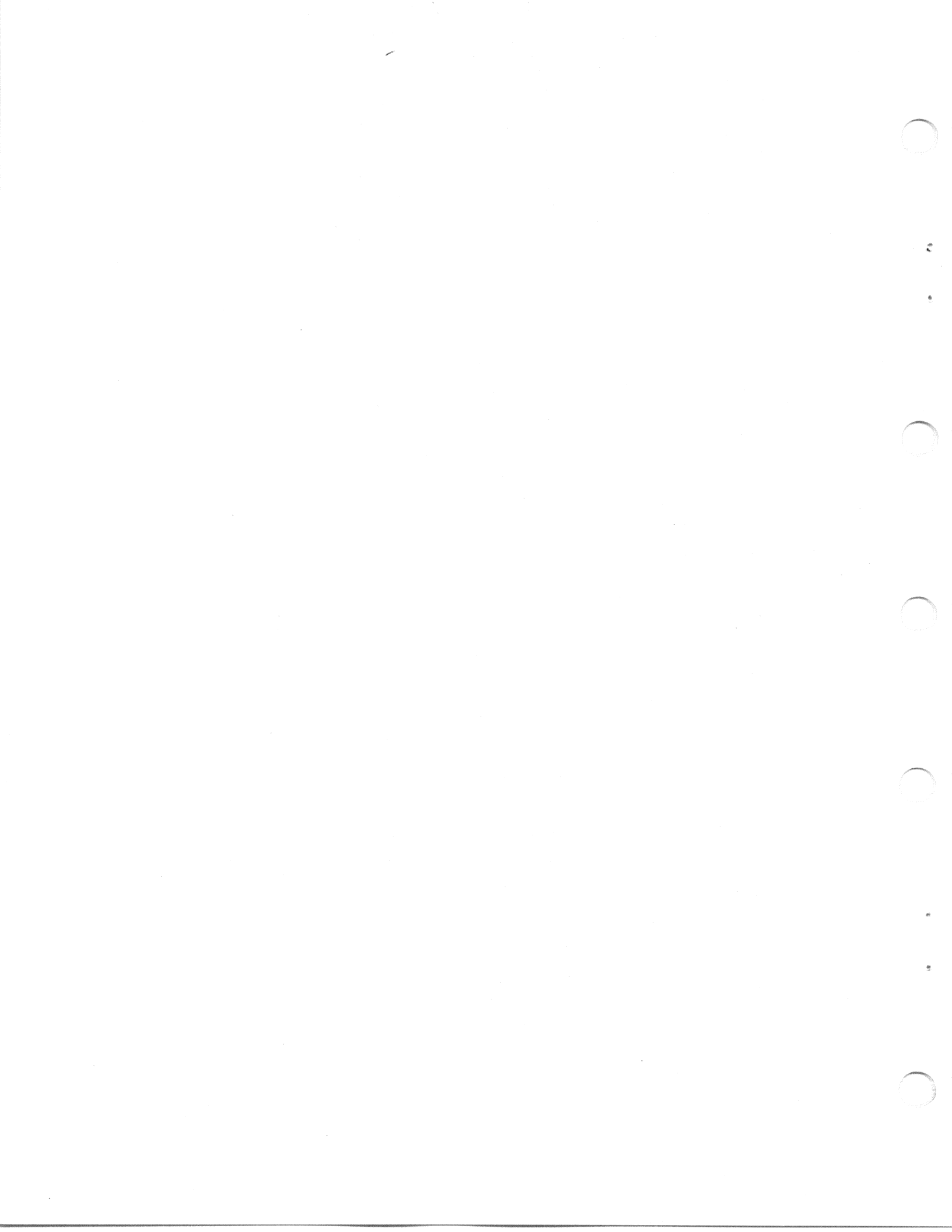

CONTENTS

INTRODUCTION

CHAPTER 1 COMMUNICATION

- General
- Serial Character Format
- Break Signal
- Character Transmit and Receive Rates
- EIA Interface
- Modem Control
- Disconnect
- Input Buffer Overflow Prevention

CHAPTER 2 CHARACTER PROCESSING

- General
- Introduction
- Printable Characters
- Control Characters
- Escape and Control Sequences
- Control Strings
 - Answerback Message
 - Graphics

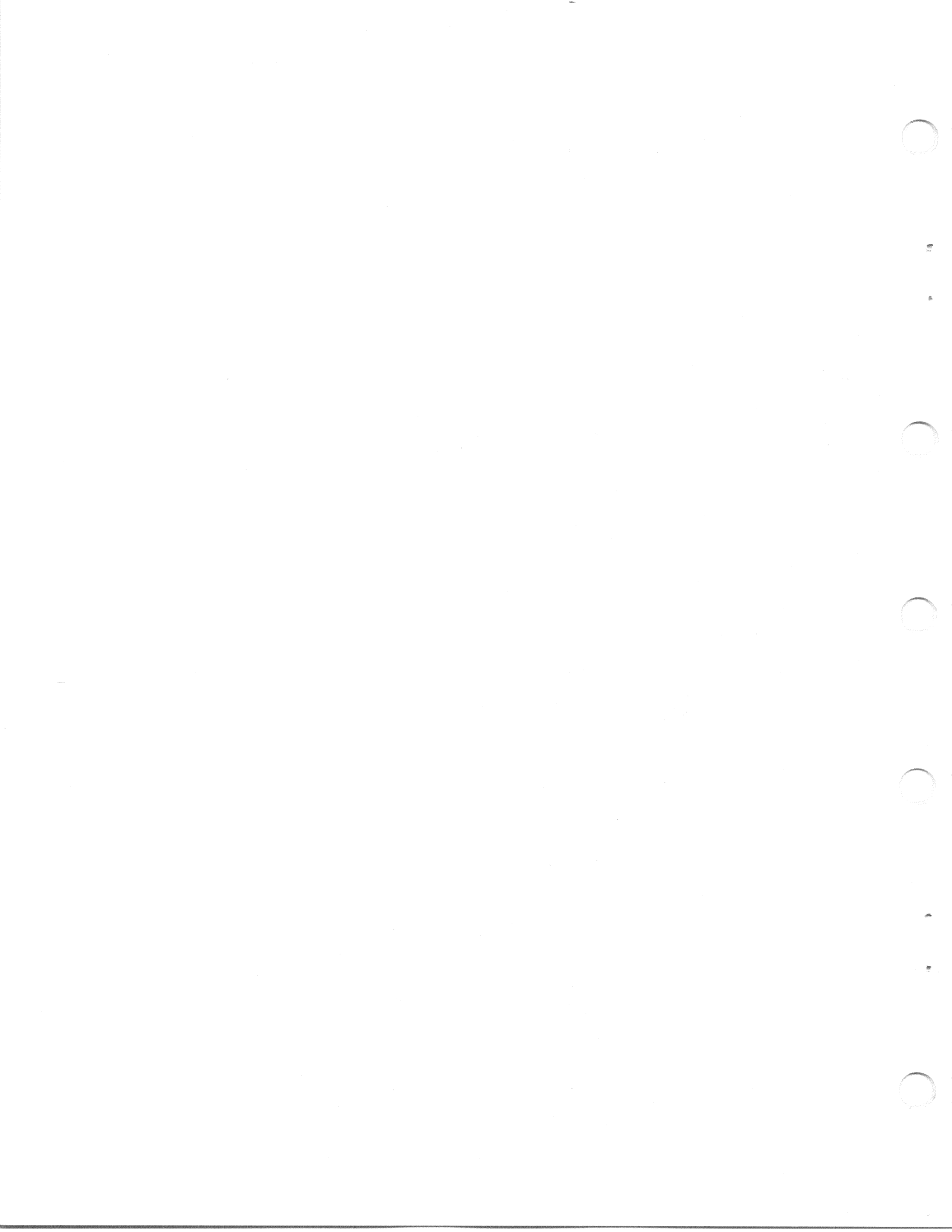

INTRODUCTION

The Letterprinter 100 User Documentation Packages cover all Letterprinter 100 model terminals. The User Documentation is written for three general audiences:

- ^ the hardware installer requiring specific installation and checkout information,
- ^ the operator requiring general operating information,
- ^ the applications programmer requiring interface and control function descriptions.

The documentation for the Letterprinter 100 is divided into three books:

- ^ Installation Guide
- ^ Operator Guide
- ^ Programmer Reference Guide

This book describes the interface and receive character processing information for the Letterprinter 100 terminals. The programmer should use this manual as a reference when writing application software.

The Programmer Reference Guide is divided into the following chapters:

Chapter 1 Communication -- describes the terminal interface and communication features.

Chapter 2 Character Processing -- describes the terminal response to printable characters control characters, escape sequences, and control strings.

WARNINGS, CAUTIONS AND NOTES

In this book, warnings, cautions, and notes are used for specific purposes. Warnings are used to highlight information used to prevent personal injury. Cautions highlight information used to prevent damage to the terminal. Notes are used to highlight general information.

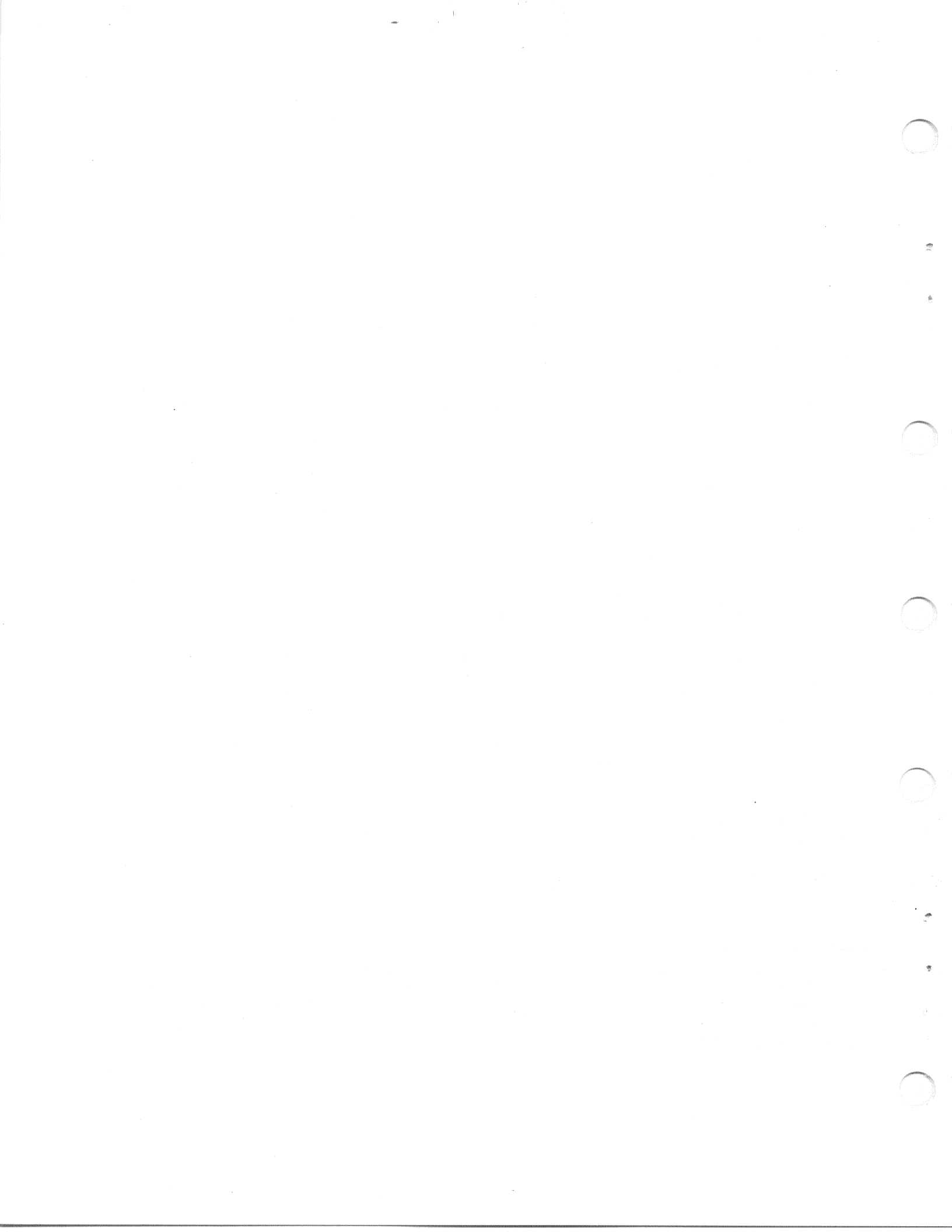

CHAPTER 1 COMMUNICATION

GENERAL

This chapter describes LA100 communication interfaces and the terminal communication features. The communication features are used to configure the terminals to operate with specific computers. This chapter also discusses the methods of controlling data received by the terminal to avoid input buffer overflows.

SERIAL CHARACTER FORMAT

The LA100 communicates using serial characters (Figure 1-1). The serial character format for the terminal must match the character format used by the computer. Serial characters are transmitted using a start bit, 7 or 8 data bits, a selectable parity bit and 2 stop bits.

NOTE:\n\nIf you are using the LA12X-BB Parallel Interface option, refer to the option installation guide for character format information.

The data bits represent a 7 bit character, least significant bit leading. If 8 bit characters are selected, the last data bit is forced to the space (0) condition and the eighth data bit is ignored when receiving characters. The parity bit is operator selectable.

BREAK SIGNAL

A break signal is a transmitted space condition for 0.275 seconds + 10 percent. The computer response to the break signal depends on the computer and the software used. If selected, the LA100 sends a break signal when a paper fault occurs.

EIA INTERFACE INFORMATION

The terminal operates on full-duplex, asynchronous communication lines. The EIA interface connector is a DB-25 male 25 pin connector mounted on the back of the terminal (Figure 1-2). The LA100 EIA interface signals meet the EIA specification requirements RS-232-C and the International Telephone and Telegraph Consulting Committee (CCITT) recommendation V.24.

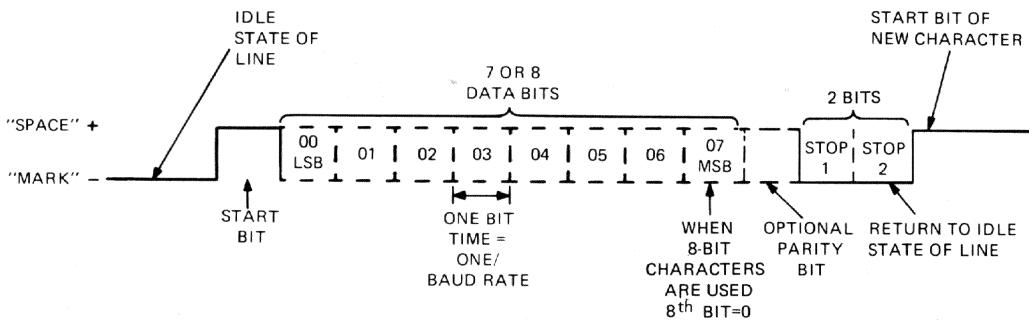

MA-7815A

Figure 1-1 Serial Character Format

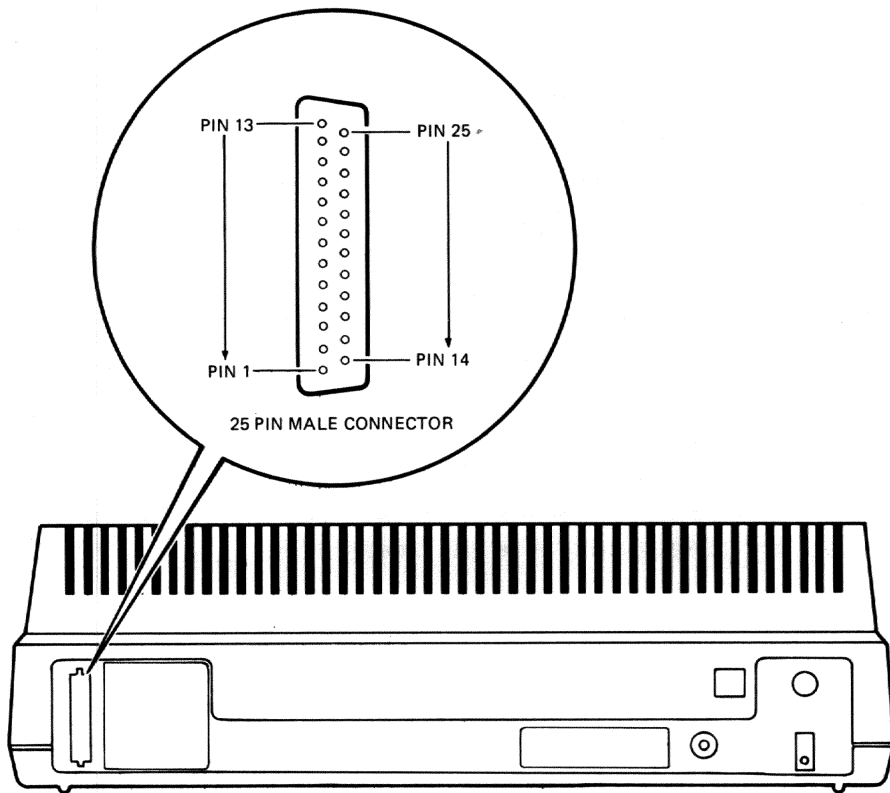

MA-7255

Figure 1-2 EIA Connector

NOTE:\n\nThe 20 mA current loop interface option allows the terminal to be connected directly to a computer up to 305 m (1000 ft) away without the use of a modem.

Table 1-1 summarizes the EIA connector signals and the following paragraphs explain each signal as used in the LA100. The Communication Feature section explains the effect that the communication features have on the EIA control signals.

Protective Ground -- Pin 1

This circuit is connected to the chassis of the terminal. It is also connected to external grounds through the third wire of the power cord.

Transmitted Data (TXD) -- Pin 2
Direction: From terminal

Signals on this circuit represent serially encoded characters that are generated by the terminal.

Received Data (RXD) -- Pin 3
Direction: To terminal

Signals on this circuit represent serially encoded characters that are generated by the user's equipment.

Request to Send (RTS) -- Pin 4
Direction: From terminal

When the RTS signal is on, the terminal intends to receive data.

Clear to Send (CTS) -- Pin 5
Direction: To terminal

This circuit monitors the CTS signal generated by the modem in response to RTS. With modem control selected, the LA100 will not transmit any codes if CTS is not on. With no modem control selected, CTS is always assumed to be on.

Data Set Ready (DSR) -- Pin 6
Direction: To terminal

The DSR signal is on when the data set is ready. The terminal will not transmit or receive data until this signal is on. With no modem control selected, DSR is always assumed to be on. The DSR indicator lights when the DSR signal is received.

Signal Ground -- Pin 7

This circuit establishes a common ground reference potential for all interface circuits. This circuit is permanently connected to the protective ground circuit.

Table 1-1 EIA Interface Signals

Pin	Name	Mnemonic	CCITT/EIA Designation	Source
1	Protective Ground	PGND	101/AA	
2	Transmitted Data	TXD	103/BA	LA100
3	Received Data	RXD	104/BB	User
4	Request to Send	RTS	105/CA	LA100
5	Clear to Send	CTS	106/CB	User
6	Data Set Ready	DSR	107/CC	User
7	Signal Ground	SGND	102/AB	
8	Receive Line	RLSD	109/CF	User
9	Signal Detect			
9	No Connection			
10	No Connection			
11	Restraint	BUSY		LA100
12	Speed Indicator	SPDI	CI	User
13	No Connection			
14	No Connection			
15	No Connection			
16	No Connection			
17	No Connection			
18	No Connection			
19	Secondary Request to Send	SRTS	120/SCA	LA100
20	Data Terminal Ready	DTR	108.2/CD	LA100
21	No Connection			
22	No Connection			
23	Speed Select	SPDS	111/CH	LA100
24	No Connection			
25	No Connection			

Receive Line Signal Detect (RLSD) - Pin 8
Direction: To terminal

When the RLSD signal is on, it indicates that the modem has received the data carrier signal. The terminal will not receive data until this signal is on. With no modem control selected, RLSD is always assumed to be on.

Restraint (BUSY) - Pin 11
Direction: From terminal

With restraint selected, the on condition of BUSY indicates that the computer should temporarily stop sending data. When BUSY goes off, the computer can resume sending data.

Speed Indicator (SPDI) - Pin 12
Direction: To terminal

With speed mode selected, the terminal operates at the operator selected baud rate when SPDI is off. The terminal operates at 1200 baud regardless of the operator selected rate when SPDI is on.

Secondary Request to Send (SRTS) - Pin 19
Direction: From terminal

Same as restraint (pin 11)

Data Terminal Ready (DTR) -- Pin 20
Direction: From terminal

When the DTR signal is on, the terminal is capable of receiving data. When DTR is off, the terminal is processing a disconnect or the terminal is local.

Speed Indicator (SPDS) - Pin 23
Direction: From terminal

With speed mode selected, and the receive baud rate of the terminal is 1200 baud or higher, the terminal turns SPDS on. Otherwise SPDS is kept off.

EIA CIRCUIT JUMPERS

The following EIA circuits can be physically disconnected by removing a jumper:

- Protective Ground - EIA connector Pin 1
- Busy - EIA connector Pin 11
- Speed Indicator - EIA connector Pin 12
- Secondary Request to Send - EIA connector Pin 19
- Speed Select - EIA connector Pin 23

When any of the EIA circuit jumpers are removed, the loopback control line test fails. Refer to the jumper removal procedure in the Installation guide to remove any of the EIA circuit jumpers.

CONNECTING TO THE COMPUTER

The LA100 can be connected to a computer directly or through a common carrier facility (telephone line) as shown in Figure 1-3. The EIA interface or optional 20mA current loop interface can be used in both applications.

When connecting the terminal to the computer through the telephone line, a modem (data set) is needed. The modem changes the serial characters transmitted between the terminal and the computer into signals that can be transmitted over the telephone lines. Several types of modems can be used with the LA100. However, the modem used by the terminal must be compatible with the modem used by the computer.

The type of communication used by the terminal must also be compatible with the computer and the communication system. The type of communication used by the LA100 is operator selectable (SET-UP is used for the Letterwriter 100, communication switches are used for the Letterprinter 100).

MODEM CONTROL

When on-line, the LA100 is connected to the communication line and is capable of receiving and sending data. The terminal communicates with EIA compatible devices on full duplex asynchronous communication lines.

The terminal supports two basic types of full-duplex communication; with or without modem control. Both methods allow data to be transmitted and received at the same time. When full-duplex with no modem control is selected, the data transmission and reception is always enabled when not in local. Full-duplex with modem control requires that both the terminal and the modem recognize the proper EIA signals before transmitting data. Table 1-2 shows the effect of the modem/no modem feature on the EIA control signals.

No modem control allows the terminal to communicate directly with a computer (null modem configurations) or with full-duplex modems that do not support DSR (data set ready) or RLSD (receive line signal indicator).

Modem control allows the terminal to communicate through modems such as Bell 103, 212, Vadic 3400, or equivalent.

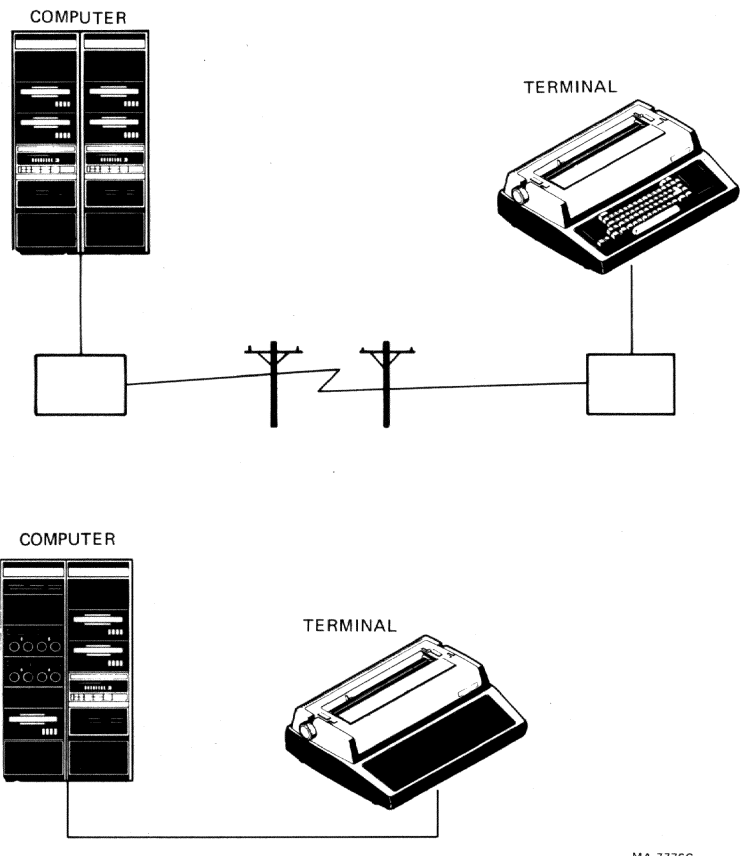

MA-7776C

Figure 1-3 Connecting to the Computer

Table 1-2 Modem Control Affect on EIA Signals

EIA Signal	No Modem	Modem Control
DTR	active	active
RTS	active	active
TXD	active	active
RXD	active	active
DSR	inactive	active
CTS	inactive	active
RLSD	inactive	active

Key

Off Signal off at EIA connector
 Active Signal turns on or off depending on terminal state.
 On Signal on at EIA connector
 Inactive Signal ignored at EIA connector but terminal internally forces signal on.

FULL-DUPLEX DISCONNECT

A full-duplex disconnect is accomplished by turning DTR (data terminal ready) off for at least two seconds plus the DSR (data set ready) delay time, but no greater than 3.8 seconds. The following conditions cause a full-duplex disconnect.

- ^ DSR turns off after DTR is on
- ^ RLSD turns off for more than two seconds
- ^ Wrong number time out (DSR is on, then RLSD does not turn on within 20 seconds)
- ^ If the paper fault switch is set to disconnect and a paper out condition occurs
- ^ If the terminal is switched to local (for Letterprinter 100, press SELF TEST key; for Letterwriter 100, press LINE/LOC key until LINE indicator goes off)
- ^ EOT control character received while coded disconnect is enabled

INPUT BUFFER OVERFLOW PREVENTION

When the LA100 receives a character (other than the NUL and DEL characters), the terminal stores the character in its 400 character input buffer. When the terminal is ready, characters are removed from the input buffer and printed. If the terminal falls behind by more than 400 characters, the input buffer overflows. If an overflow occurs, the character is lost, a single SUB control character is placed in the input buffer and the bell tone sounds. There are three ways to avoid input buffer overflows.

1. Use the XON/XOFF or restraint feature to signal the data source when to temporarily stop or resume sending data. Using the XON/XOFF or restraint feature allows maximum throughput and eliminates the need for fill character calculations and message size limits. These features are explained in detail later in this chapter.
2. Send data only as fast as it can be printed. When receiving data at 1200 baud or less the terminal can keep up with character reception. However, very short lines and multiple form feeds are not processed this fast. Also, characters received faster than 1200 baud cannot be processed that quickly. In these cases, fill characters are used to slow down the effective data transmission speed. Fill time formulas are given in the following Fill Time Formulas section.
3. Limit the number of characters in the message to the terminal's input buffer size. If the buffer is empty at the beginning of the transmission, the terminal can receive a message of 400 characters without a buffer overflow.

XON/XOFF and Restraint

The XON/XOFF and restraint features are used to prevent input buffer overflows. When XON/XOFF and/or restraint is selected, the terminal constantly monitors the number of characters stored in the input buffer. The terminal signals the computer to stop sending data (sends XOFF control character or sets the restraint signal off) when any of the following conditions occur:

- ^ Number of characters in the input buffer exceeds 200 characters
- ^ Terminal transmits XOFF and then receives 60 characters

The terminal signals the computer to resume data transmission (sends XON control character or sets the restraint signal on) when any of the following conditions occur:

- ^ When the number of characters in the input buffer is less than 60 characters
- ^ Terminal is switched on-line (or powered up on-line)

XON/XOFF and restraint are operator selectable features.

Fill Time Formulas

When receiving data at 1200 baud or less, the terminal can keep up with normal character reception. Very short lines and multiple form feeds cannot be printed this fast. Fill characters may be used to slow down the effective data transmission speed in these cases. Fill characters do not enter the input buffer they are stripped out of the data stream upon reception.

The terminal's printhead and form movements (horizontal and vertical) terminal are directly related to the fill time required to slow down the effective data transmission speed. The fill time required to compensate for these movements can be converted to the number of fill characters needed using the following formula.

$$\text{Number of Fill Characters} = \frac{\text{Fill Time Required}}{\text{Character Execution Time}}$$

NOTE: \n\nNUL is the only recommended fill character even though some other characters may seem to achieve the same result in special cases.

Determining Fill Time Required

Required fill time for horizontal Movement (including tabs and positioning sequences) is determined in the following way.

First figure the actual number of columns moved. Then, allow 15 ms for each of the first 10 columns (30 ms in double-width pitches: 5, 6, 6.6, 8.25) and 5.5 ms for each additional column (11 ms in double-width pitches).

Required fill time for vertical movement (includes linefeeds, vertical tabs, form feeds, and vertical positioning sequences) is determined in the following way.

First convert the number of lines moved to actual distance moved using the following formula.

$$\text{Inches Moved} = \frac{\text{Number of Lines Moved}}{\text{Vertical Pitch}}$$

Then allow 38 ms for the first line moved up to 1/6 inch, and 200 ms for each additional inch.

Character Execution Time

The character execution time is given in milliseconds and is based on a given baud rate. It is the time the computer takes to slow down the effective data transmission speed to the terminal. Character execution times at the applicable baud rates are shown in Table 1-3.

Fill Time Formula Examples

1. Horizontal Movement

Assumed values: Baud Rate = 1200, Horizontal Pitch = any single width pitch (10, 12, 13.2, 16.5). Also assume that horizontal tab stops are set at columns 9, 17, and 25 and printing begins at column 9. If the next two characters received are TAB TAB, calculate the number of fill characters required in the following way.

First, calculate the number of columns moved using the following formula.

$$\text{Final Column} - \text{Current Column} = \text{Number Columns Moved}$$

$$25 - 9 = 16$$

Then allow 15 ms per column for the first 10 columns and 5.5 ms per column for the remaining columns.

$$15 \text{ ms} \times 10 = 150 \text{ ms}$$

$$5.5 \text{ ms} \times 6 = 33 \text{ ms}$$

$$150 + 33 \text{ ms} = 183 \text{ ms}$$

The fill time required is 183 ms.

Next, divide the fill time required by the character execution time found in Table 1-3.

Table 1-3 Character Execution Times

Baud Rate	Execution Times (msec)
110	90.0
300	33.3
600	16.6
1200	8.3
1800	5.5
2400	4.1
4800	2.0
9600	1.0

NOTE:\n\nCharacter execution times are provided for calculation of fill times only.

Number Fill Characters Required = 183 ms
8.3 ms

The number of fill characters required is 22.04. Round this number off to the next whole number, which is 23. Twenty three (23) fill characters (NUL) should follow the two tabs.

2. Vertical Movement

Assumed values: Baud Rate = 1200 baud, Vertical Pitch = 6 lines per inch and paper is set to line 10. Also assume the next characters received are nine line feeds.

First, calculate the actual distance moved using the following formula.

$$\begin{aligned} \text{Number Inches Moved} &= \frac{\text{Lines Moved}}{\text{Vertical Pitch}} \\ 1\frac{1}{2} \text{ inches} &= \frac{9}{6} \end{aligned}$$

Then allow 38 ms for the first 1/6 inch moved and 200 ms for the remaining number of inches moved.

$$200 \text{ ms} \times 1 \frac{2}{6} \text{ inches} = 266 \text{ ms}$$

$$266 \text{ ms} + 38 \text{ ms} = 304 \text{ ms}$$

The fill time required is 304 ms.

Next, divide the fill time required by the character execution time found in Table 1-3.

$$\begin{aligned} \text{Number fill characters required} &= 266 \text{ ms} \\ &8.3 \text{ ms} \end{aligned}$$

The number of fill characters required is 32.04. Round this number off to the next whole number, which is 33. Thirty three (33) fill characters (NUL) should follow the nine line feeds.

CHAPTER 2 CHARACTER PROCESSING

GENERAL

This chapter describes the terminals' response to received characters. The terminal processes characters according to American National Standards Institute (ANSI) standards X3.64-1979, X3.4-1977 and X3.41-1977. The ANSI system defines the American National Standard Code for Information Interchange (ASCII) chart shown in Figure 2-1. Figure 2-1 shows each character with its binary, octal, decimal, and hexadecimal values.

The terminal processes a received character based on the type of character as defined by ANSI. The position of the character in the ASCII chart determines the type of character as either a printable character or control character.

The ASCII chart is eight columns wide. The control characters are in columns zero and one. The rest of the chart contains printable characters (except for SP and DEL). The DEL (delete) character is always a control character. The SP can be considered either an information separator control character or a printable character.

A character sent from the computer to the first goes through the application program, then through the terminal handler of the computer, then through the character processor of the terminal, then finally creates a terminal action.

To know exactly what action is caused by a character sent from your application program you have to make sure that all the following parts of the system are set properly:

- Application program
- Transmitting part of the terminal handler
- Receiving part of the terminal
- General terminal settings

To set the terminal, refer to this book and the Operator Guide; to set the terminal handler, refer to your operating system guide; to set the application program, refer to your application guide.

BITS				0 0		0 0 1		0 1 0		0 1 1		1 0 0		1 0 1		1 1 0		1 1 1	
B7	B6	B5	B4	COLUMN		COLUMN		COLUMN		COLUMN		COLUMN		COLUMN		COLUMN		COLUMN	
B3	B2	B1	ROW	0	1	2	3	4	5	6	7	8	9	10	11	12	13	14	15
0	0	0	0	NUL	0	20	SP	40	0	60	@	100	P	120	`	140	p	160	
0	0	0	1		1	16	!	32	1	48	A	101	Q	121	a	141	q	161	
0	0	1	0		2	17	"	33	2	49	B	102	R	122	b	142	r	162	
0	0	1	1		3	18	#	34	3	50	C	103	S	123	c	143	s	163	
0	1	0	0		4	19	\$	35	4	51	D	104	T	124	d	144	t	164	
0	1	0	1	ENQ	5	20	%	36	5	52	E	105	U	125	e	145	u	165	
0	1	1	0		6	21	&	37	6	53	F	106	V	126	f	146	v	166	
0	1	1	1	BEL	7	22	'	38	7	54	G	107	W	127	g	147	w	167	
1	0	0	0	BS	8	23	(39	8	55	H	110	X	130	h	150	x	170	
1	0	0	1	HT	9	24)	40	9	56	I	111	Y	131	i	151	y	171	
1	0	1	0	LF	10	25	*	41	:	57	J	112	Z	132	j	152	z	172	
1	0	1	1	VT	11	26	+	42	;	58	K	113	[133	k	153	{	173	
1	1	0	0	FF	12	27	,	43	<	59	L	114	\	134	l	154		174	
1	1	0	1	CR	13	28	-	44	=	60	M	115]	135	m	155	}	175	
1	1	1	0	SO	14	29	.	45	>	61	N	116	^	136	n	156	~	176	
1	1	1	1	SI	15	30	/	46	?	62	O	117	_	137	o	157	DEL	177	
						31		47		63				93		110		127	
						32		48		64				94		111		128	
						33		49		65				95		112		129	
						34		50		66				96		113		130	
						35		51		67				97		114		131	
						36		52		68				98		115		132	
						37		53		69				99		116		133	
						38		54		70				100		117		134	
						39		55		71				101		118		135	
						40		56		72				102		119		136	
						41		57		73				103		120		137	
						42		58		74				104		121		138	
						43		59		75				105		122		139	
						44		60		76				106		123		140	
						45		61		77				107		124		141	
						46		62		78				108		125		142	
						47		63		79				109		126		143	
						48		64		80				110		127		144	
						49		65		81				111		128		145	
						50		66		82				112		129		146	
						51		67		83				113		130		147	
						52		68		84				114		131		148	
						53		69		85				115		132		149	
						54		70		86				116		133		150	
						55		71		87				117		134		151	
						56		72		88				118		135		152	
						57		73		89				119		136		153	
						58		74		90				120		137		154	
						59		75		91				121		138		155	
						60		76		92				122		139		156	
						61		77		93				123		140		157	
						62		78		94				124		141		158	
						63		79		95				125		142		159	
						64		80		96				126		143		160	
						65		81		97				127		144		161	
						66		82		98				128		145		162	
						67		83		99				129		146		163	
						68		84		100				130		147		164	
						69		85		101				131		148		165	
						70		86		102				132		149		166	
						71		87		103				133		150		167	
						72		88		104				134		151		168	
						73		89		105				135		152		169	
						74		90		106				136		153		170	
						75		91		107				137		154		171	
						76		92		108				138		155		172	
						77		93		109				139		156		173	
						78		94		110				140		157		174	
						79		95		111				141		158		175	
						80		96		112				142		159		176	
						81		97		113				143		160		177	
						82		98		114				144		161		178	
						83		99		115				145		162		179	
						84		100		116				146		163		180	

KEY

ASCII CHARACTER	ESC	33	OCTAL
		27	DECIMAL
		1B	HEX

MA-7247

Figure 2-1 ASCII Chart

For example:

A form feed control character (octal 014) sent from the application program may not be executed by the terminal because the terminal is not set for form handling, or because the terminal handler is set to change form feed into multiple line feeds.

An escape control character (octal 033) may be changed into a dollar sign by the terminal handler or the application program.

A horizontal tab control character (octal 011) may be changed into spaces by the application program or the terminal handler, or may not be executed because no tab is set in the terminal.

Lower case characters may be changed into uppercase characters.

The following paragraphs describe both printable characters and control characters.

PRINTABLE CHARACTERS

The terminal receives printable characters and stores the characters in a line buffer. The characters are printed when one of the following conditions occur:

- no character received for more than 30 ms
- paper motion
- overprint command (except underline)

If the active column is not greater than the right margin, each received character is printed and the active column is incremented. The actual character printed depends on the character code received, the font selected, and the character set selected.

CONTROL CHARACTERS

A control character is a single character control function used to control terminal operation. Control characters are not printed. When the LA100 receives a control character the terminal responds by performing the action associated with the control character. The LA100 responds to the control characters listed in Table 2-1. Table 2-1 also lists each control character's mnemonic, and function. All other control characters received by the terminal cause no action.

NOTE: Each control function listed in this chapter has a mnemonic. The mnemonic is an abbreviation of the control function name.

ESCAPE AND CONTROL SEQUENCES

Escape and control sequences are used to provide additional controls that are not provided by the control characters in the character set. These sequences are multiple character control functions that are not printed but are used to control the printing

Table 2-1 ANSI Control Characters

Name	Mnemonic	Octal Code	Function
Null	NUL	000	Used as fill characters (See Communication Chapter).
End of Transmission	EOT	004	Used as disconnect character if enabled.
Enquiry	ENQ	005	Request answerback message.
Bell	BEL	007	Sounds audible bell tone.
Backspace	BS	010	Moves the active column left one column.
Horizontal Tab	HT	011	Advances to next horizontal tab stop.
Line Feed	LF	012	Advances to next line. Performs carriage return if enabled.
Vertical Tab	VT	013	Advances to next vertical tab stop.
Form Feed	FF	014	Advances to next top margin
Carriage Return	CR	015	Returns to left margin. Performs line feed if enabled.
Shift Out	SO	016	Switches to G1 printer character set.
Shift In	SI	017	Switches to G0 printer character set.
Cancel	CAN	030	Immediately ends any control or escape sequence.
Substitute	SUB	032	Immediately ends any control or escape sequence. Characters received with errors are replaced by SUB if enabled. SUB is printed as " ".
Escape	ESC	033	Introduces an escape sequence.
Delete	DEL	177	No operation (not stored in the input buffer).

and processing of characters. Escape and control sequences are defined in ANSI standards X3.41 1977 and X3.64 1979. Refer to Appendix C for more detail on escape and control sequence processing.

NOTE:\n\nIf an escape or control sequence is aborted in the middle of the sequence, it is not clear what action the following character will have. It is therefore recommended that any abort be followed by a cancel control character or a no action escape sequence ESC \ (octal 033 127).

For example: some operating systems echo CTL (control) C as ↑ C. The sequence ESC CTL C then becomes ESC ↑ C which puts the terminal in ANSI string processing mode. If this occurs the terminal discards printable characters (see ANSI string processing). if the host does not send the cancel control character. To recover from this mode, if the computer does not send the cancel control character; enter and exit SET-UP for the Letterwriter 100, enter and exit SELF TEST for the Letterprinter 100.

Detailed Sequence Definitions

The following paragraphs describe in detail the escape and control sequences to which the LA100 responds. These sequences are described in the following order.

- Line Feed New Line Mode
- Auto Wraparound Mode
- Density Select Mode
- Pitch Select Mode
- Printer Character Set Designation
- Font Selection
- Request Font Configuration
- Report Font Configuration
- Horizontal Pitch (Characters Per Inch)
- Horizontal Margins
- Horizontal Tabs
- Vertical Pitch (Lines Per Inch)
- Form Length
- Vertical Margins
- Vertical Tabs
- Active Column and Active Line
- Product Identification

Line Feed New Line Mode -- defines the terminals' response to the line feed control character. When this mode is off and the terminal receives a line feed control character, the terminal increments the active line and advances the paper one line. When this mode is on, a received line feed control character causes the terminal to return the active column to the left margin in addition to its usual functions. Use the following sequences to enable or disable line feed new line mode.

NOTE: \n\nCarriage return line feed mode is operator selectable only. Refer to the Operator Guide for more detail.

Name	Mnemonic	Sequence	Function
Line feed new line mode	LNM	ESC [2 0 h 033 133 062 060 150	Set line feed new line mode on.
		ESC [2 0 1 033 133 062 060 154	Set line feed new line mode off.

Auto Wraparound Mode -- determines where the next character is printed when received while the active position is greater than the right margin. When this mode is off, any characters received while the active position is at the right margin are not printed. When this mode is on, any characters received while the active position is greater than the right margin are printed starting at the left margin on the next line. Use the following sequences to enable or disable auto wraparound mode.

Name	Mnemonic	Sequence	Function
Auto wrap around mode	DECAWM	ESC [? 7 h 033 133 077 067 150	Set auto wraparound mode on.
		ESC [? 7 1 033 133 077 067 154	Set auto wraparound mode off.

Quality Select Mode -- determines if received characters are printed in letter mode (medium or high density, depending on character ROM) or draft mode. See Figure 2-2 for examples.

The standard DPSS are designed to print in draft mode (7 X 9 character) or letter mode/high density (33 X 18 character). Some of the optional DPSS are designed to print in draft mode (7 X 9 character) or letter mode/medium density (33 X 9 character). Selecting letter mode selects either 33 X 18 or 33 X 9 characters, depending on the DPS selected.

NOTE: Medium and high density DPSS can both be resident in the terminal.

The terminal only responds to these sequences when the AUTO/MAN key is in the automatic (up) position. When the AUTO/MAN key is in the down position and the LTR/DRAFT key is used to select the print quality, any quality select sequence sent to the terminal is processed and stored. The sequences are performed when the AUTO/MAN key is set to the automatic (up) position.

Use the following sequences to change the quality select feature.

Name	Mnemonic	Sequence	Function
Quality select		ESC [0 " z 033 133 060 042 172	Set quality select mode to default (draft mode).

```
!"#%&'()*+,-./0123456789:;<=>?@ABCDEFGHIJKLMNPOQRSTUVWXYZ[\]^_`abcd
"#$%&'()*+,-./0123456789:;<=>?@ABCDEFGHIJKLMNPOQRSTUVWXYZ[\]^_`abcde
#$%&'()*+,-./0123456789:;<=>?@ABCDEFGHIJKLMNPOQRSTUVWXYZ[\]^_`abcdef
%&'()*+,-./0123456789:;<=>?@ABCDEFGHIJKLMNPOQRSTUVWXYZ[\]^_`abcdefg
```

DRAFT MODE

```
!"#$%&'()*+,-./0123456789:;<=>?@ABCDEFGHIJKLMNPOQRSTUVWXYZ[\]^_`abcd
"#$%&'()*+,-./0123456789:;<=>?@ABCDEFGHIJKLMNPOQRSTUVWXYZ[\]^_`abcde
#$%&'()*+,-./0123456789:;<=>?@ABCDEFGHIJKLMNPOQRSTUVWXYZ[\]^_`abcdef
%&'()*+,-./0123456789:;<=>?@ABCDEFGHIJKLMNPOQRSTUVWXYZ[\]^_`abcdefg
```

LETTER MODE (MEDIUM DENSITY)

```
!"#$%&'()*+,-./0123456789:;<=>?@ABCDEFGHIJKLMNPOQRSTUVWXYZ[\]^_`abc
"#$%&'()*+,-./0123456789:;<=>?@ABCDEFGHIJKLMNPOQRSTUVWXYZ[\]^_`abcd
#$%&'()*+,-./0123456789:;<=>?@ABCDEFGHIJKLMNPOQRSTUVWXYZ[\]^_`abcde
%&'()*+,-./0123456789:;<=>?@ABCDEFGHIJKLMNPOQRSTUVWXYZ[\]^_`abcdef
```

LETTER MODE (HIGH DENSITY)

MA-8300

Figure 2-2 Character Density Examples

Quality select	ESC [1 " z Ø33 133 Ø61 Ø42 172	Set quality select mode to draft mode.
Quality select	ESC [2 " z Ø33 133 Ø62 Ø42 172	Set quality select mode to letter mode (medium density).
Quality select	ESC [3 " z Ø33 133 Ø63 Ø42 172	Set quality select mode to letter mode (high density).

Pitch Select Mode -- selects font pitches or all pitches. When the terminal is set to all pitch the terminal can print any of the eight horizontal pitch selections available. This is useful when the terminal is used as a line printer (with draft density selected). When font pitch is selected, the terminal will print at the single width pitch of the current font (10 or 12 characters per inch) or its double width (5 or 6 characters per inch) only. This is useful when printing draft copies of future letter quality documents because the draft quality copy will look like the letter quality copy. Use the following sequences to select font pitch or all pitch.

Name	Mnemonic	Sequence	Function
Pitch select mode		ESC [? 2 9 h Ø33 133 Ø77 Ø62 Ø71 15Ø	Set pitch select mode to font pitches.
Pitch select mode		ESC [? 2 9 l Ø33 133 Ø77 Ø62 Ø71 154	Set density select mode to all pitches.

Printer Character Set Designation -- The character sets are usually language sets with some exceptions; the VT100 line drawing set, symbol, etc. The character sets that the terminal can actually print depends on the Dot Pattern Set (DPS) that the terminal is using and the character set selected. If the DPS currently used contains the character set selected, that character set is used. If the DPS currently used does not contain the character set selected, the default character set for that DPS is used. The standard DPSS contain the following character sets:

```

^   ISO United Kingdom
^   USASCII
^   DIGITAL Finnish
^   DIGITAL Norwegian/Danish
^   DIGITAL Swedish
^   ISO German
^   DIGITAL French Canadian
^   ISO French
^   ISO Italian
^   ISO Spanish
^   DIGITAL VT100 line drawing set

```

Four of these character sets can be preselected (designated). Two character sets are locking (remains active until next command), two are nonlocking (remains active for one printable character only). The two locking character sets are designated by the computer as G0 and G1 using the select character set (SCS) sequence. Once the character sets are designated by the computer, a single control character is used to switch between the active character sets. The shift in (SI, octal 017) control character selects the G0 character set. The shift out (SO, octal 016) control character selects the G1 character set.

The designated character sets are used until another select character set (SCS) sequence is received. The G0 and G1 character sets can be redesignated by the computer using the select character set (SCS) sequence as often as needed.

The sequence used to designate the G0 character set is ESC (octal 033 050), followed by a valid final character. The sequence used to designate the G1 character set is ESC) (octal 033 051), followed by a valid final character.

The two nonlocking character sets are designated G2 and G3 using the select character set (SCS) sequence. The G2 and G3 character sets are activated for only one character at a time. They are activated using the single shift 2 (ESC N) (octal 033 115) for G2 and single shift 3 (ESC O) (octal 033 116) for G3 sequences. The terminal returns to the previously used character set after the single character is printed.

The sequence used to designate the G2 character set is ESC * (octal 033 052), followed by a valid final character. The sequence used to designate the G3 character set is ESC + (octal 033 053), followed by a valid final character.

Table 2-2 lists the currently available character sets and their valid final characters.

Font Selection -- The LA100 can print characters in different fonts or styles. Changing a font changes the shape of the character but does not change the character itself. Digital currently provides the following fonts:

- Courier
- Gothic
- Orator
- Symbols

Additional fonts will be available in the future. The terminal can contain up to five fonts accessible at a given time. If the multiple font option is installed, the terminal only responds to these sequences when the option is set to computer select. When the operator forces a font from the multiple font option any font select sequences sent to the terminal are processed and stored. The sequences are performed when the option is set to computer select.

Table 2-2 Character Set Final Characters

Character Set	Final Character
ISO United Kingdom	A 101
USASCII	B 102
DIGITAL Finnish	5 065
DIGITAL Norwegian/Danish	6 066
DIGITAL Swedish	7 067
ISO German	K 113
DIGITAL French Canadian	9 071
ISO French	R 122
DIGITAL VT100 line drawing set	0 060
ISO Italian	Y 131
ISO Spanish	Z 132

This sequence is also used to set or clear the underline attribute. This feature is used to underline characters. Use the following sequences to select a font or the underline attribute.

NOTE: \n\nIf the selected font is not installed, the terminal selects the default (font 1).

Name	Mnemonic	Sequence	Function
Font select		ESC [4 m 033 133 064 155	Select underline
Font select		ESC [0 m 033 133 060 155	Clear underline
Font select		ESC [1 0 m 033 133 061 060 155	Select Font 1
Font select		ESC [1 1 m 033 133 061 061 155	Select Font 2
Font select		ESC [1 2 m 033 133 061 062 155	Select Font 3
Font select		ESC [1 3 m 033 133 061 063 155	Select Font 4
Font select		ESC [1 4 m 033 133 061 064 155	Select Font 5

Request Font Configuration -- causes the terminal to send the font font configuration report to the computer. Send the following sequence to the LA100 to request font configuration.

Request Font Configuration	ESC [? 1 0 c 033 133 077 061 060 143	Causes LA100 to send font configuration report ESC [? Pn ; Pn SP D once for each installed font.
----------------------------	--	--

NOTE: SP represents the space character (octal 040).

Report Font Configuration -- the terminal responds to the font configuration request with the sequence ESC [? Pn ; Pn SP D once for each installed font. The first parameter in the sequence is the font selection code. One selection code is available for each font.

Font	Selection Code
Font 1	10
Font 2	11
Font 3	12
Font 4	13
Font 5	14

NOTE:\n\nFont selection code 10 is always present and sent last.
It therefore indicates the end of the report.

The second parameter indicates the font type. The font type code indicates the following information.

Font Code	Indicates:
1 - 64	2 density font
65 - 128	3 density font
129 - 200	custom font

If the font code is an odd number less than 127, the font contains the USASCII and United Kingdom character sets. If the font code is an even number less than 128, the font contains the following character sets.

- United Kingdom
- USASCII
- Finnish
- Norwegian/Danish
- Swedish
- German
- French Canadian
- French
- Italian
- Spanish
- VT100 line drawing set

At this time the currently assigned font codes are:

Font Code	Font Type
03	Gothic 12, US and UK character sets
07	Courier 12, US and UK character sets
11	Symbol 10, US and UK character sets
05	Courier 10, US and UK character sets
06	Courier 10, standard overlay
09	Orator 10, US and UK character sets

NOTE:\n\nRefer to the ROM Option Documentation for more codes.

Horizontal Pitch (Characters Per Inch) -- Horizontal pitch determines the width of printed characters as well as their spacing. The terminal has eight horizontal pitch selections (Figure 2-3). Any combinations of pitch may be used on a single print line.

NOTE:\n\nThe actual horizontal pitch used by the terminal depends on the density select mode, pitch select mode and horizontal pitch features. Refer to all three features when attempting to select horizontal pitch.

Changing the horizontal pitch modifies the active column. The modified new active column is the first column boundary at or to the right of the physical position of the previous active column in the old pitch. New active column is calculated in the following way.

$$\text{New column} = 1 + \frac{(\text{Old column} - 1) \times \text{New pitch}}{\text{Old pitch}}$$

New column = 1 +

Old pitch

where New column = the new active column
 New pitch = the new pitch in inches per character
 Old column = the old active column
 Old pitch = the old pitch in inches per character

The division performed above is an integer division. Any remainder or fractional part of the quotient is discarded.

Changing horizontal pitch also clears horizontal margins. The left margin is set to column one and the right margin is set to the maximum column for the selected pitch (Table 2-3).

The horizontal pitch default selection is 10 characters per inch (char/in). The following sequences are used to set horizontal pitch.

Name	Mnemonic	Sequence	Function
Set horizontal pitch	DECSHORP	ESC [0 w 033 133 060 167	Set horizontal pitch to 10 char/in
		ESC [1 w 033 133 061 167	Set horizontal pitch to 10 char/in
		ESC [2 w 033 133 062 167	Set horizontal pitch to 12 char/in

5 CHARACTERS PER INCH
6 CHARACTERS PER INCH
6.6 CHARACTERS PER INCH
8.25 CHARACTERS PER INCH
10 CHARACTERS PER INCH
12 CHARACTERS PER INCH
13.2 CHARACTERS PER INCH
14.5 CHARACTERS PER INCH

MA-8323

Figure 2-3 Horizontal Pitch Examples

ESC [3 w	Set horizontal pitch
Ø33 133 Ø63 167	to 13.2 char/in
ESC [4 w	Set horizontal pitch
Ø33 133 Ø64 167	to 16.5 char/in
ESC [5 w	Set horizontal pitch
Ø33 133 Ø65 167	to 5 char/in
ESC [6 w	Set horizontal pitch
Ø33 133 Ø66 167	to 6 char/in
ESC [7 w	Set horizontal pitch
Ø33 133 Ø67 167	to 6.6 char/in
ESC [8 w	Set horizontal pitch
Ø33 133 Ø70 167	to 8.25 char/in

Horizontal Margins -- The left horizontal margin specifies the first printable column on a line; the right horizontal margin specifies the last printable column on a line. Printing is permitted only within the left and right margins inclusive (Figure 2-4).

The set horizontal margins sequence when accompanied by two parameters, sets the left and right margins. If both parameters are not zero, and the first is the smaller of the two, the left margin is set to the first specified parameter and the right margin is set to the second. The carriage is then repositioned to the new left margin.

NOTE:\n\nChanging the horizontal pitch modifies the horizontal margins. The left margin is set to column one and the right margin is set to the maximum right margin in the selected horizontal pitch (Table 2-3).

The sequence is ignored if the first parameter is greater than the second parameter. The sequence is also ignored if one of the specified parameters would set the right margin further right than 13.2 inches.

If the first parameter in the sequence is omitted, the remaining parameter sets the right margin to the specified value. If an attempt is made to set the right margin to the left of the left margin, the sequence is ignored.

If the second parameter in the sequence is omitted, the first parameter sets the left margin to the specified value. If an attempt is made to set the left margin to the right of the right margin, the sequence is ignored. If the active column is less than the new left margin, it is set to the new left margin and the carriage is repositioned.

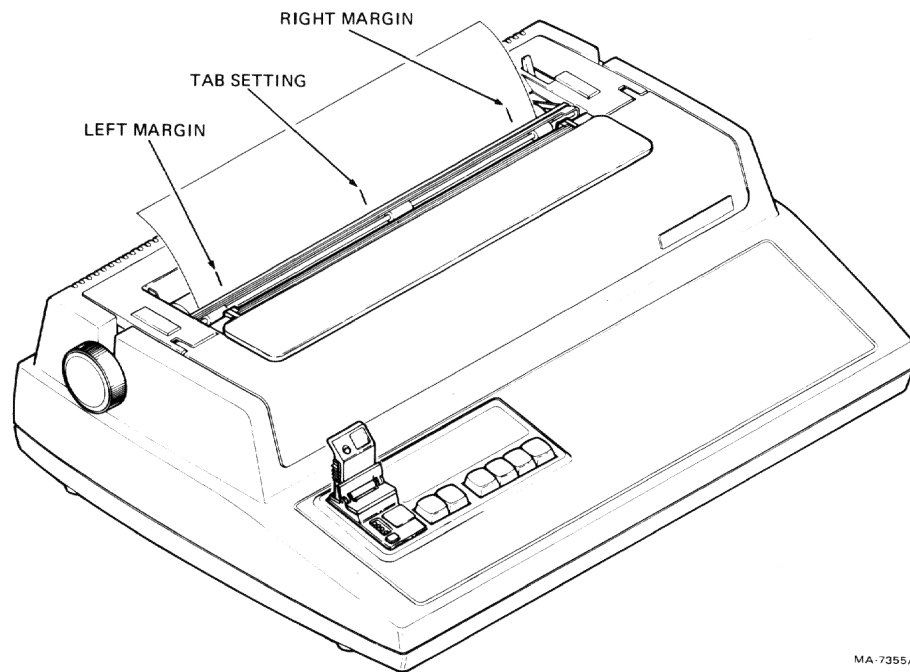

MA-7355A

Figure 2-4 Horizontal Margins and Tabs

Table 2-3 Maximum Right Margins

Horizontal Pitch	Maximum Column
10	132
12	158
13.2	168
16.5	216
5	66
6	79
6.6	84
8.25	108

If both parameters are zero or omitted, the margins are unchanged. The default setting for the left margin is column one. The default setting for the right margin is column 132.

The following sequence is used to set the left and right margins.

Name	Mnemonic	Sequence	Function
Set left and right margins	DECSLRM	ESC [Pn ; Pn s 033 133 *** 073 *** 163	Set left and right margins to the values given

NOTE: The *** character is used to indicate variable numeric parameters within the octal representation of the control or escape sequence.

Horizontal Tabs -- A horizontal tab is a preselected point on a line to which the print head advances when a horizontal tab control character is received (Figure 2-4). The LA100 has 217 possible horizontal tab stops, one for each column. Tab stops are associated with column numbers, not physical positions on the paper. Therefore, changing horizontal pitch also changes the physical position of tab stops. Each stop may be set or cleared independently. Setting a stop already set has no effect; the same is true for clearing a stop already cleared. Tab stops may be set or cleared regardless of margins or horizontal pitch. The default settings for horizontal tabs are one every nine columns.

The following sequences are used to set or clear horizontal tab stops.

Name	Mnemonic	Sequence	Function
Horizontal tabulation set	HTS	ESC H 033 110	Set horizontal tab stop at active column
Horizontal tabulation set	DECHTS	ESC l 033 061	Set horizontal tab stop at active column
Tabulation clear	TBC	ESC [0 g 033 133 060 147	Clear horizontal tab at active column
Tabulation clear	TBC	ESC [2 g 033 133 062 147	Clear all horizontal tab stops
Tabulation clear	TBC	ESC [3 g 033 133 063 147	Clear all horizontal tab stops
Clear All horizontal tabs	DECCAHT	ESC 2 033 062	Clear all horizontal tab stops

NOTE:\n\nThe *** character is used to indicate variable numeric parameters within the octal representation of the control or escape sequence.

Set	DECSHTS	ESC [Pn	;	...	Pn	u	Set
horizontal		033 133	***	073	...	***	165	horizontal
tabs								tab stops at the given values

*Vertical Pitch -- Vertical pitch determines the spacing between lines, not the height of printed characters (Figure 2-5). The LA100 has six vertical pitch selections. Changing vertical pitch changes:

- ^ the active line. Causes the active line to move down on the next vertical motion command so that the distance between the top margin and the active line is an integer multiple of the pitch selected.
- ^ the action of the form length command.
- ^ the action of set top and bottom margin commands.
- ^ the position of the last printed line on the form. The last printed line will always be above the bottom margin.
- ^ the position of the vertical tabs.

* Note that the vertical pitch feature is different from previous DIGITAL terminals.

Changing vertical pitch does not affect:

- ^ the top of form reference.
- ^ the form length.
- ^ the top margin. The first line will always be printed at the same position.
- ^ the bottom margin. The last line will never be printed below the bottom margin.

The vertical pitch default selection is six lines per inch. The following sequences are used to set vertical pitch.

Name	Mnemonic	Sequence	Function
Set vertical pitch	DECVERP	ESC [0 z 033 133 060 172	Set vertical pitch to six lines per inch
		ESC [1 z 033 133 061 172	Set vertical pitch to six lines per inch

ESC [2 z	Set vertical pitch to
Ø33 133 Ø62 172	eight lines per inch
ESC [3 z	Set vertical pitch to
Ø33 133 Ø63 172	twelve lines per inch
ESC [4 z	Set vertical pitch to
Ø33 133 Ø64 172	two lines per inch
ESC [5 z	Set vertical pitch to
Ø33 133 Ø65 172	three lines per inch
ESC [6 z	Set vertical pitch to
Ø33 133 Ø66 172	four lines per inch

***Form Length --** The LA1ØØ can operate in one of two modes: form mode or no form mode (roll paper). In the no form mode, there is no form length or vertical margins, printing occurs continuously, lines being spaced apart according to the current pitch.

* Note that the form length feature is different from previous DIGITAL terminals.

When in form mode, the terminal will not print above the top margin or below the bottom margins, and lines will be spaced so that the distance between active line and top margin is always a multiple of the current pitch. (Figure 2-6).

When a form length of zero is defined for the terminal, the LA1ØØ assumes that roll paper is being used and enters the no form mode, When a non zero form length is given, the terminal assumes that form paper is being used, and enters the form mode.

The form length is measured in lines 1/24 of an inch. The form length can be no longer than 21 inches. To set form length, first try to ensure that the terminal is at the top of form.

NOTE:\n\nRemember that the a form feed puts the active line at the top margin, not the top of form. To advance to the top of form the top margin must be cleared.

Measure the form length in inches. Ensure that you know the current vertical pitch of the terminal and that the new form length is a multiple of this pitch. If the current pitch is unknown or the form length is not a multiple of the vertical pitch, set a new vertical pitch.

NOTE:\n\nMost form lengths are a multiple of 1/12, and all allowed form lengths are either a multiple of 1/12 or 1/8.

Then, send the form length command with the parameter equal to the form length multiplied by the current vertical pitch.

The default form length selection is 11 inches. The following sequence sets form length.

FORM

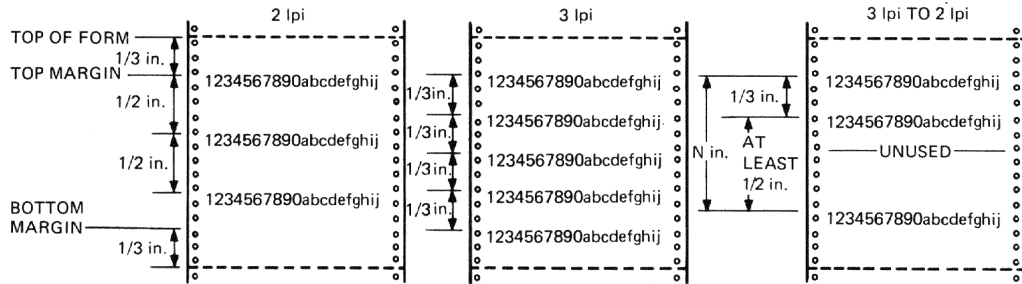

NOTE:
ALWAYS START PRINTING AT TOP MARGIN OR AT SOME DISTANCE FROM TOP MARGIN THAT IS A MULTIPLE OF THE CURRENT VERTICAL PITCH. NEVER PRINT BELOW BOTTOM MARGIN.

NO FORM

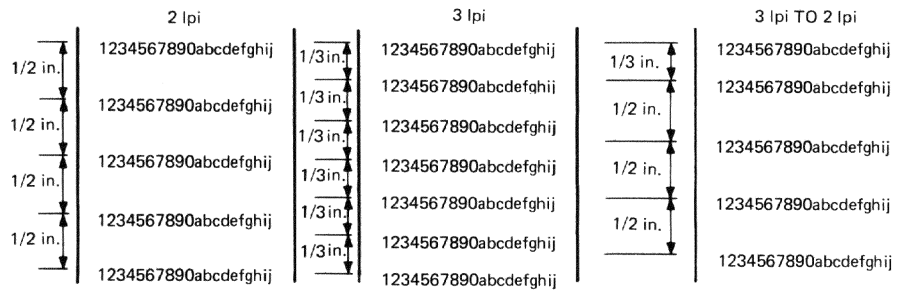

NOTE:
ALWAYS PRINT LINES EVENLY ACCORDING TO VERTICAL PITCH.

MA-838B

Figure 2-6 Form/No Form Mode

Name	Mnemonic	Sequence	Function
Set lines per physical page	DECSLPP	ESC [Pn t 033 133 *** 164	Set form length to n X pitch in inches, set top margin to 0 inches, active line to line one, set top of form to current position, and a set bottom margin to form length.

NOTE:\n\nThe *** character is used to indicate variable numeric parameters within the octal representation of the control or escape sequence.

Vertical Margins -- The top vertical margin specifies the first printable line; the bottom vertical margin specifies the limit for the last printable line (Figure 2-8). Printing is allowed only on the lines between the top and bottom margins (including the top margin). The bottom margin may not be included depending on the vertical pitch.

To set the top and bottom margins, first be sure that the distance between the top of form and the desired margin is a multiple of the vertical pitch selected. Otherwise, change the pitch and then send the set margin command with a parameter equal to the desired margin in inches multiplied by the current vertical pitch in lines per inch.

Attempting to print above the top margin or below the bottom margin automatically advances the active line to the top margin of the next page. For example, a line feed (LF) received at the bottom margin causes the terminal to perform a form feed.

The set vertical margins sequence, accompanied by two parameters, set the top and bottom margins. If both parameters are not zero and the first is the smaller of the two, the top margin is set to the first parameter and the bottom is set to the second. Then the paper may be repositioned to the new top margin depending on the current line position and terminal activity.

The sequence is ignored if the first parameter is greater than or equal to the second parameter. The sequence is also ignored if one of the specified parameters would set the bottom margin past the assigned form length.

If the first parameter in the sequence is omitted, the remaining parameter sets the bottom margin to the specified line. If an attempt is made to set the bottom margin above the top margin, the sequence is ignored.

If the second parameter in the sequence is omitted, the first parameter sets the top margin to the specified line. If an attempt is made to set the top margin below the bottom margin, the sequence is ignored. If the active line is less than the new top margin, it is set to the new top margin and the paper is repositioned.

If both parameters are set to zero or omitted the margins are unchanged. The default top margin selection is top of form. The default selection for the bottom margin is 11 inches.

The following sequences set the top and bottom margins.

Name	Mnemonic	Sequence	Function
Set top, bottom margins	DECSTBM	ESC [Pn ; Pn r 033 133 *** 073 *** 162	Set top margin to line Pn and bottom margin to line Pn

NOTE:\n\nThe *** character is used to indicate variable numeric parameters within the octal representation of the control or escape sequence.

Vertical Tabs -- A vertical tab is a preselected line to which the print head advances when a vertical tab control character is received (Figure 2-7). The terminal has 168 vertical tab positions. Vertical tabs may be set and cleared like horizontal tabs. Vertical tab stops are associated with specific line numbers, not physical positions on the paper. Therefore, changing vertical pitch changes the printing position of vertical tabs on the paper. The default settings for vertical tabs are one every line. The following sequences set or clear vertical tab stops.

NOTE:\n\n21 inches at 12 lines per inch = 252 lines. Only the first 168 lines can have vertical tab stops.

Name	Mnemonic	Sequence	Function
Vertical tab set	VTS	ESC J 033 112	Set vertical tab stop at active line
Vertical tab set	DECVTS	ESC 3 033 063	Same

NOTE:\n\nThe *** character is used to indicate variable numeric parameters within the octal representation of the control or escape sequence.

Name	Mnemonic	Sequence	Function
Set vertical tab stops	DECSVTS	ESC [Pn ; ... Pn v 033 133 *** 073 *** 166	Set vertical tab stops at lines given

Tabulation clear	TBC	ESC [1 g Ø33 133 Ø61 147	Clear vertical tab stop at active line
Tabulation clear	TBC	ESC [4 g Ø33 133 Ø64 147	Clear all vertical tab stops
Clear All vertical tabs	DECCA VT	ESC 4 Ø33 Ø64	Same

Active Column and Active Line -- Active column is the column where the next character will be printed. Active line is the line where the next character is printed. Column and line numbers begin with one, not zero. Printable characters usually increment the active column. Line feeds, vertical tabs, and form feeds increment the active line.

The active column and active line are collectively known as active position. Active position is only loosely linked to the physical position of the carriage and paper mechanism.

When auto last character view is selected, the terminal carriage moves .4 inches to the right whenever printing stops for more than one second. This action allows the last character printed to be viewed. However active column is not affected by this feature. Bell characters do not have an active position attribute. They are not guaranteed to be sounded at any particular position.

In addition to the control characters (backspace, horizontal tab, carriage return, line feed, vertical tab, and form feed) the following escape sequences modify active column and active line.

Name	Mnemonic	Sequence	Function
Index	IND	ESC D Ø33 1Ø4	Increment active line and advance paper -- line feed new line mode has no effect on this feature

NOTE: \n\nThe *** character is used to indicate variable numeric parameters within the octal representation of the control or escape sequence.

Vertical position absolute	VPA	ESC [Pn d Ø33 133 *** 144	Set active line to Pn- if Pn is less than or equal to active line, or is greater than bottom margin, active line is set to top margin on next page
----------------------------------	-----	-------------------------------	--

Next line	NEL	ESC E Ø33 1Ø5	Set active column to left margin and increment active line
Horizontal position absolute	HPA	ESC [Pn Ø33 133 *** 14Ø	Set active column to column Pn -- if Pn is greater than right margin, active column is set to left margin on next line -- if Pn is less than or equal to left margin, active column is set to left margin
Horizontal position relative	HPR	ESC [Pn a Ø33 133 *** 141	Advance current active column by Pn columns -- if active column exceeds right margin, active column is set to left margin on next line regardless of actual value of Pn -- if Pn = Ø, then no motion occurs
Cursor up	CUU	ESC [Pn A Ø33 133 *** 1Ø1	Decrement current active line by Pn lines without going past top margin -- if Pn is greater than or equal to current active line, sequence is ignored
Vertical position relative	VPR	ESC [Pn e Ø33 133 *** 145	Advance active line by Pn lines -- if Pn = Ø, 256 lines is assumed, if parameter exceeds bottom margin, active line is set to top margin on next page regardless of actual value of Pn

NOTE:\n\nThe PLD sequence does not modify active line. To avoid losing the top of form reference send an equal number of PLU sequences to the terminal.

Partial line down	PLD	ESC K Ø33 113	Index paper up .212 cm (1/12 inch) -- line feed new line mode has no effect on this sequence
-------------------	-----	------------------	--

NOTE:\n\nThe PLU sequence does not modify active line. To avoid losing the top of form reference, send an equal number of PLD sequences to the terminal.

Partial line up	PLU	ESC L Ø33 114	Index paper down .212 cm (1/12 inch) -- line feed new line mode has no effect on this sequence
Reverse index	RI	ESC M Ø33 115	Decrement active line and move paper down one line -- line feed new line mode has no effect on this sequence

Product Identification -- The LA1ØØ automatically transmits an answer to the ANSI standard request for device attributes. The following sequences cause the terminal to transmit its product identification sequence.

Name	Mnemonic	Sequence	Function
Device attributes	DA	ESC [c Ø33 133 143	Transmits ESC [? 1 Ø c which forms the product identification of the basic LA1ØØ.
Device attributes	DA	ESC [Ø c Ø33 133 Ø6Ø 143	Same
*Identify terminal	DECID	ESC Z Ø33 132	Same

* This sequence is provided for compatibility with previous products. It may not be supported in future products and is therefore not recommended.

ANSI CONTROL STRINGS

When the terminal receives any of the escape sequences listed below, it responds as usual to control characters received (octal ØØØ -- Ø37 and 177) and discards any printable characters received (octal Ø4Ø -- 176). The terminal reverts to text processing mode when one of the following conditions occur.

- ^ ESC \ (octal Ø33 134) is received.
- ^ CAN (cancel), SUB (substitute), or ESC (escape) is received
- ^ an error occurs.

Name	Mnemonic	Sequence
Application program command	APC	ESC 033 137
Operating system command	OSC	ESC] 033 135
Privacy message	PM	ESC ^ 033 136
Device control	DCS	ESC P 033 120

NOTE: The LA100 remains in DCS mode until it recognizes a valid protocol selector, or the terminal receives the terminator sequence ESC \. For more detail on DCS mode refer to the Graphics Mode and Answerback Message sections in this chapter.

GRAPHICS MODE

While in text mode, characters are printed as they are received. In graphics mode, characters received define specific columns of dots to be printed. Graphics mode allows users to print dot combinations anywhere on a page. This mode can be used to draw pictures and plot graphs (Figure 2-8).

After entering graphics mode, the vertical pitch, horizontal pitch, and horizontal margins change. The graphics mode pitch and margins section describes these changes.

DIGITAL does not recommend using single sheet or tractor feed paper when operating in graphics mode.

The terminal has a horizontal resolution of 132 columns per inch with a 50 percent overlap, and a vertical resolution of 72 dots per inch with no overlap between dots. There is a 44 percent dot overlap between lines. The aspect ratio (ratio of horizontal to vertical resolution) is 1.83.

GRAPHICS STRING FORMAT

The format for a string of graphics data is as follows.

DCS introducer	ESC P
Protocol selector	Pn q
Data	Control characters or column definitions
DCS terminator	ESC \

DCS INTRODUCER

When the terminal receives the DCS introducer, it enters DCS mode and waits for the correct protocol selector. The DCS introducer is the ANSI DCS introducer sequence ESC P (octal 033 120).

When the protocol selector is received the terminal begins to process data as described in the data section.

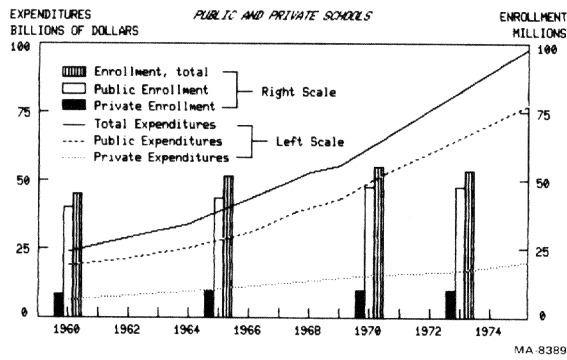
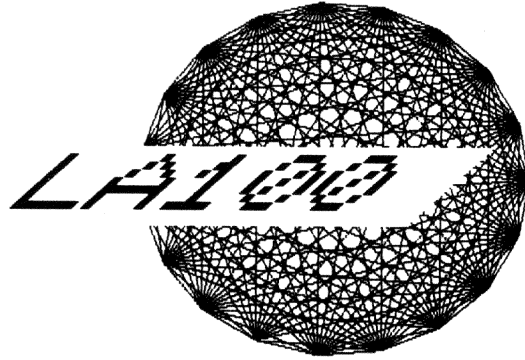

Figure 2-8 Graphics Capabilities

The terminal remains in DCS mode if the proper protocol selector is not received, or if the terminal receives a character that is out of range before the correct protocol selector is recognized.

PROTOCOL SELECTOR

After receiving the DCS introducer, the protocol selector causes the terminal to enter graphics mode. The protocol selector for the terminal consists of a numeric parameter and a final character. The correct protocol selector is l (octal 061) and q (octal 161). Valid protocol selectors include:

- 0 selects default graphics protocol (same as l for LA100)
- 1 selects DECwriter IV protocol (described in this section)
- 2 - 255 reserved for future development.

DATA

The data contained within a graphics string can either be control characters or printable data. The following paragraphs describe the control characters to which the terminal responds in graphics mode, and the format of the printable characters received.

Control Characters

In graphics mode, the terminal responds to the following control characters.

^ ANSI Control Characters

Table 2-4 lists and describes the ANSI control characters in the 000 to 037 octal range that are processed in graphics mode.

^ Private Control Characters

Table 2-5 lists and describes the private control characters in the 040 -- 076 octal range that are processed in graphics mode.

Printable Data

After the proper protocol selector is received, any character received in the 077 -- 176 octal range is considered printable data. These characters define a column of six dots to be printed. This allows selective firing of the top six printhead wires (Figure 2-9). The seventh, eighth and ninth printhead wires are not used in graphics mode.

Printable characters are processed in the following way. The offset (octal 077) is subtracted from the binary value of the character received. The result is a six dot column definition. A printhead wire is fired, and a dot printed, if the corresponding bit is set to one.

The least significant bit is associated with the top printhead wire (wire one). The sixth bit is associated with the sixth printhead wire, and is the last wire that can be fired in graphics mode.

Table 2-4 Graphics ANSI Control Characters

Name	Mnemonic	Octal Code	Function
Cancel	CAN	030	Immediately causes an exit graphics.
Substitute	SUB	032	Replaces any character received with errors. When received in graphics, SUB is processed as a one column space.
Escape	ESC	033	Causes the terminal to exit graphics and process the sequence.

NOTE: \n\nNUL, EOT, ENQ, BEL, DEL, SI, and SO are processed as in text mode (refer to Table 2-1).

BS, LF, CR, FF, HT, and VT are ignored in graphics.

Table 2-5 Graphics Private Control Characters

Name	Mnemonic	Octal Code	ASCII Character	Function
Graphics Repeat Introducer	DECGRI	041	!	Begin repeat sequence
Graphics Carriage Return	DECGCR	044	\$	Returns to graphics left margin
Graphics New Line	DECGNL	055	-	Returns to graphics left margin and advances to next graphics line

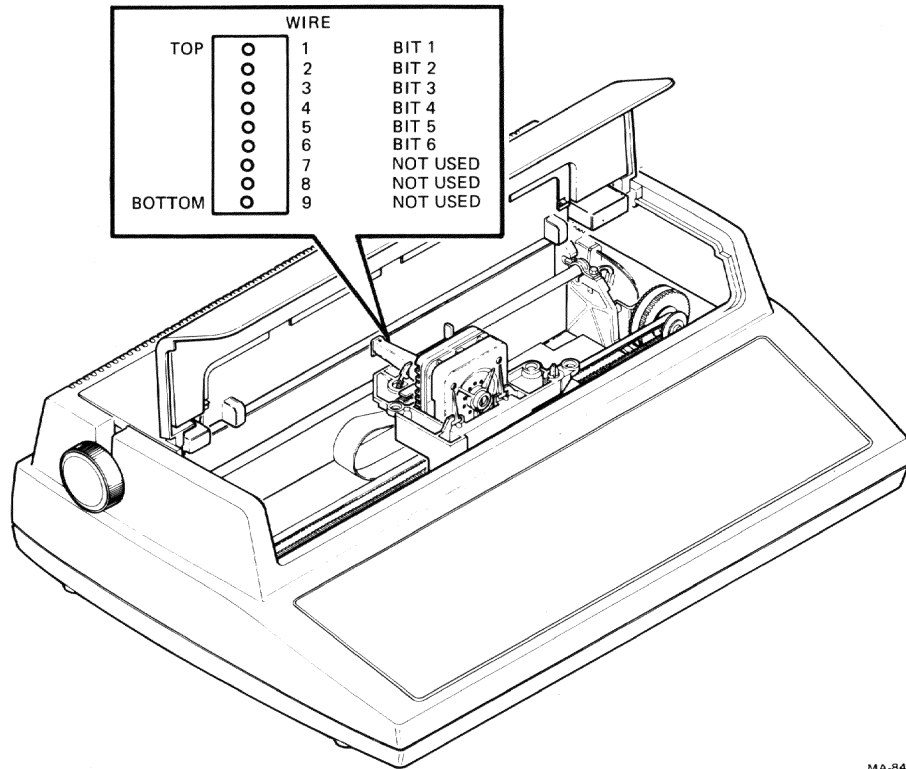

MA-8404

Figure 2-9 Graphics Printhead Use

Wire		Bit
Top	1	1
	2	2
	3	3
	4	4
	5	5
	6	6
	7	Not used
	8	Not used
Bottom	9	Not used

Refer to Table 2-6 for several printable character examples.

Repeat Sequence

A repeat sequence allows the terminal to continually print a dot column for a specified number of times. It has the same effect as receiving the dot column that many times. A repeat sequence is defined as follows.

Repeat introducer	!	(octal 041)
Numeric parameter	Number of times to print the dot column (characters in the octal range of 060 - 071)	
Dot column	Character in the 077 -- 176 octal range	

The repeat sequence introducer is the private control character ! (octal 041).

The numeric parameter specifies the number of times to print the column definition that follows. The numeric parameter is a string of characters in the 060 -- 071 octal range. If a numeric parameter is not specified, a value of zero is assumed for the numeric parameter. If the value specified is larger than the graphic printer limit for numeric parameters (64 K), the limit is assumed. All decimal digits are processed as part of the count.

The dot column (a character in the 077 -- 176 octal range) is printed as many times as specified by the numeric parameter count. All control characters received during a repeat sequence are processed as usual. For example, the control character ! resets the repeat sequence count.

All unspecified characters (octal 072 -- 076) are ignored.

DCS Terminator

The DCS terminator ESC \ (octal 033 134) causes the terminal to exit graphics mode and revert to text mode character processing. The CAN (cancel) or ESC (escape) control characters also cause the terminal to exit graphics mode. If the ESC control character is received, the terminal exits graphics mode and starts processing the escape sequence.

Table 2-6 Printable Character Examples

Character	Octal Value	Binary Value (minus Offset)	Wires Fired
?	077	00000000	o o o o o o
@	100	00000001	* o o o o o
~	176	00111111	* * * * *
_	137	00100000	o o o o o *

After an exit graphics, the terminal is set to the following:

- ^ Text mode features (margins, pitch) are restored
- ^ Vertical position is modified according to the control characters received while in graphics mode
- ^ Horizontal position is the same as just before entering graphics mode
- ^ The first text mode vertical motion command causes the terminal to advance to the next text mode line before executing the command.

GRAPHICS MODE PITCH

In graphic mode the horizontal pitch is set to 132 columns per inch (9.5 characters per inch). The vertical pitch is set to 1/12 lines per inch.

GRAPHICS MODE MARGINS

Graphics mode maximum line length depends on the horizontal pitch and the margins selected in text mode. In graphics mode, the maximum line length is 13.1 inches (1,736 dots). To use the maximum line length, the following conditions must be met before entering graphics mode.

- ^ the actual horizontal pitch must be 10 characters per inch (depends on pitch setting, pitch mode, and the density selection).
- ^ Text mode left margin must be set to column one
- ^ Text mode right margin must be set to column 132
- ^ Active column must be column one

After entering graphics mode the left margin is repositioned to the right .11 inches maximum of the last printed column in text mode. Graphics mode left margin is calculated as follows:

$$\text{Left Margin} = \frac{(\text{Current Active Column} - 1) \times \text{Old Pitch}}{70}$$

If there is a remainder, round up to the next whole number.

After entering graphics mode the right margin is repositioned to the left of the text mode right margin (.11 inches maximum). The graphics mode right margin is calculated as follows:

$$\text{Right Margin} = \frac{\text{Old Right Margin} \times \text{Old Pitch}}{70}$$

Discard any remainder.

If an attempt is made to print past the right margin, the terminal responds according to the auto wraparound mode selection.

Superscript or subscript can be used to label graphic data with text mode comments. Reverse line feed is not recommended because the graphics mode vertical pitch may not be the same as the text mode vertical pitch.

ANSWERBACK MESSAGE ENTRY

Answerback is a message up to thirty characters that identifies the terminal for the computer. This message is transmitted upon request from the computer, the keyboard (Letterwriter 100 only), or automatically if enabled (refer to the auto answerback feature in the Operator Guide).

Both printable characters and control characters can be part of the answerback message. To allow down line entry of both printable and control characters, the message is hexadecimal encoded.

Answerback Message Format

The format for an answerback message is:

DCS introducer	ESC P
Protocol selector	Pn v
Data	Encoded Answerback Message Text
DCS terminator	ESC \

DCS Introducer

When the terminal receives the DCS introducer, it enters DCS mode and waits for the correct protocol selector. The DCS introducer is the ANSI DCS introducer sequence ESC P (octal 033 120).

The protocol selector is followed by the text of the answerback message coded in hexadecimal format. The terminal remains in DCS mode if the proper protocol selector is not received, or if the terminal receives a character that is out of range before the correct protocol selector is recognized.

Protocol Selector

After receiving the DCS introducer, the protocol selector causes the terminal to enter answerback message entry mode. The protocol selector for answerback message entry consists of a numeric parameter and a final character. The correct protocol is 1 (octal 061) and v (octal 166).

NOTE:\n\nWhen the protocol selector is recognized the message stored in operating memory is erased. However the message stored in user permanent memory remains the same until the next store is performed.

Data

After the proper protocol selector is received, control characters (0 -- 037 and 177 octal range) are executed as usual.

Hexadecimal digits (character in the 060 -- 071, 101 -- 106, 141 -- 146 octal range) are grouped in pairs to give the hexadecimal equivalent of the character to be entered in the answerback message. Any character from 0 -- 177 (octal) can be entered in the answerback message using the hex encoding system (see example).

When the protocol selector is recognized the message stored in operating memory is erased. Then a character is added to the message every time a pair of hexadecimal digits has been received.

NOTE: The message is not made 30 characters long automatically. If padding NUL control characters are needed, they must be included in the message.

Example:

The following string will down line the message : LA100

DCS introducer

Protocol selector		Hex encoded message												DCS terminator	
ESC	P													ESC \	
033	120	061	166	064	103	064	061	063	061	063	060	063	060	033	134

Octal Equivalent															

Error Processing

Any character received which is not a control character or hex digit is discarded

If an odd number of digits is received, the last digit is processed by itself

If the hex value received for a character is larger than 7F HEX, the character is replaced by the SUB control character (1A HEX).

Once 30 answerback message characters are received, further characters are discarded.

